

QTLP630C-2 HER
QTLP630C-4 Green
QTLP630C-B Blue

QTLP630C-3 Yellow
QTLP630C-7 AlGaAs Red

Surface Mount LED Lamp, Standard Bright 0805

Features

- Small footprint – 2.0(L) X 1.25(W) X 1.1(H) mm
- Wide viewing angle of 140°
- Water clear optics
- Moisture-proof packaging
- Available in 0.315" (8mm) width tape on 7" (178mm) diameter reel; 2,000 units per reel

Applications

- Keypad backlighting
- Push-button backlighting
- LCD backlighting

Description

These surface mount chip LEDs are designed to fit industry standard footprint. Low profile and wide viewing angle make these LEDs ideal choices for backlighting applications and panel illumination.

Package Dimensions

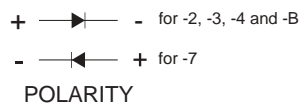
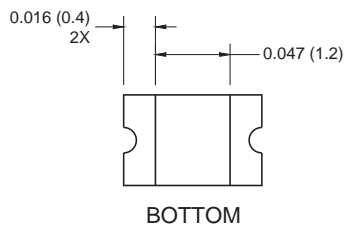
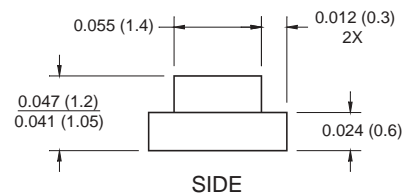
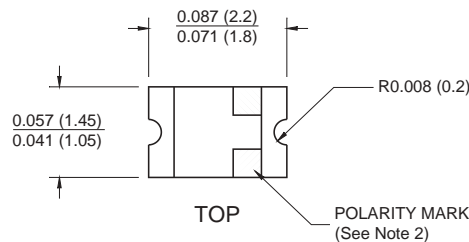

NOTE:

1. Dimensions for all drawings are in inches (mm).
2. Cathode for -2, -3, -4 and B. Anode for -7.

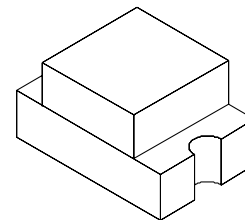

Absolute Maximum Ratings ($T_A = 25^\circ\text{C}$ unless otherwise specified)

Parameter	Symbol	QTL P630C					Unit
		-2	-3	-4	-7	-B	
Continuous Forward Current	I_F	30	30	30	30	30	mA
Peak Forward Current ($f = 1.0 \text{ KHz}$, Duty Factor = 1/10)	I_{FM}	160	160	160	180	100	mA
Reverse Voltage ($I_R = 10 \mu\text{A}$)	V_R	5	5	5	5	5	V
Power Dissipation	P_D	84	84	84	72	135	mW
Operating Temperature	T_{OPR}	-40 to +85					$^\circ\text{C}$
Storage Temperature	T_{STG}	-40 to +90					$^\circ\text{C}$
Lead Soldering Time	T_{SOL}	260 for 5 sec					$^\circ\text{C}$

Electrical/Optical Characteristics ($T_A = 25^\circ\text{C}$)

Parameter	Symbol	QTL P630C					Condition
		-2	-3	-4	-7	-B	
Luminous Intensity (mcd)							
Minimum	I_V	5	5	6	10	15	$I_F = 20\text{mA}$
Typical		10	10	10	20	20	
Forward Voltage (V)							
Maximum	V_F	2.8	2.8	2.8	2.4	4.5	$I_F = 20\text{mA}$
Typical		2.0	2.0	2.1	1.9	3.8	
Wavelength (nm)							
Peak	λ_P	635	585	565	660	430	$I_F = 20\text{mA}$
Dominant	λ_D	630	590	570	645	465	
Spectral Line Half Width (nm)	$\Delta\lambda$	45	35	30	20	65	$I_F = 20\text{mA}$
Viewing Angle ($^\circ$)	$2\theta^{1/2}$	140	140	140	140	140	$I_F = 20\text{mA}$

Typical Performance Curves

Fig. 1 Forward Current vs. Forward Voltage

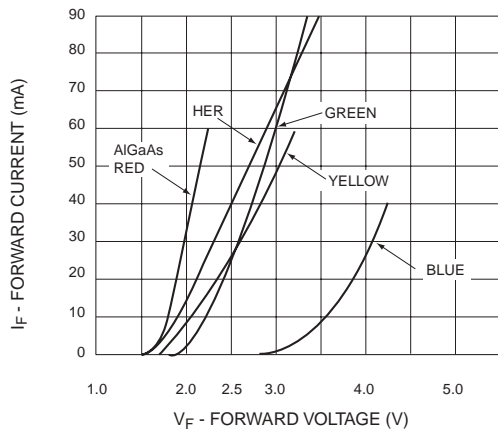

Fig. 2 Relative Luminous Intensity vs. DC Forward Current

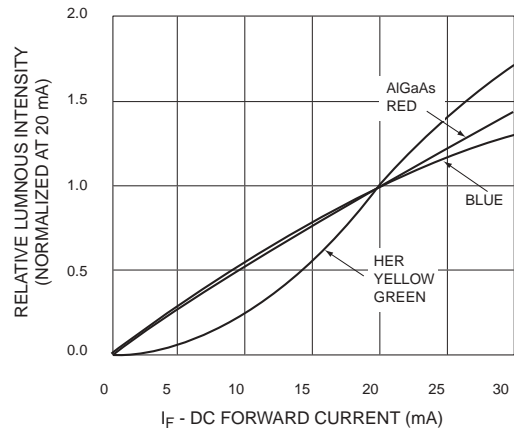

Fig. 3 Relative Intensity vs. Peak Wavelength

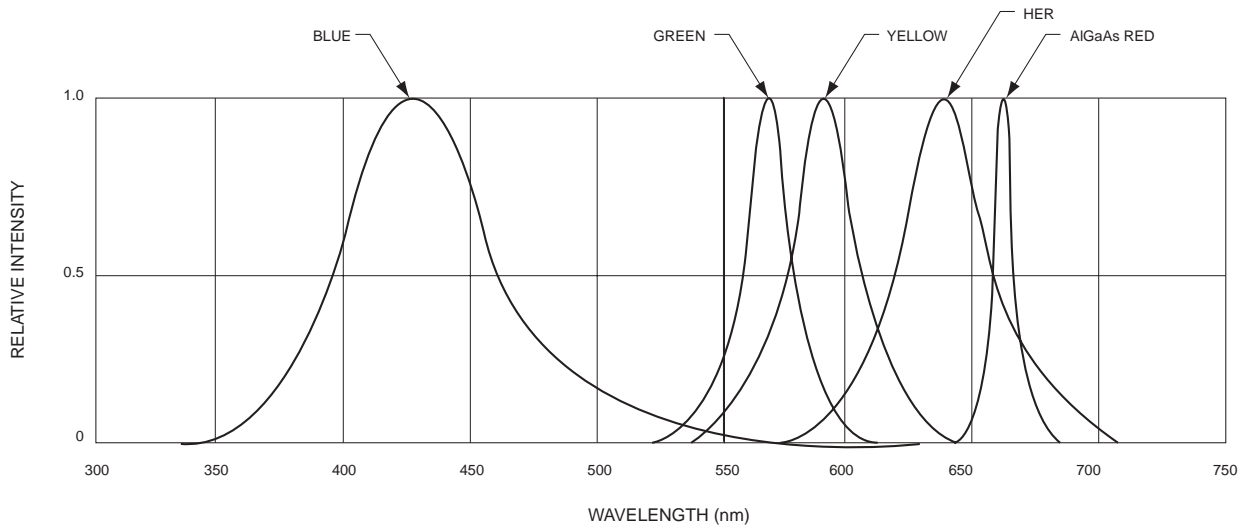

Fig.4 Radiation Diagram

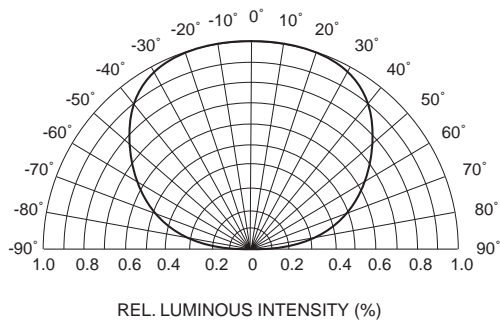
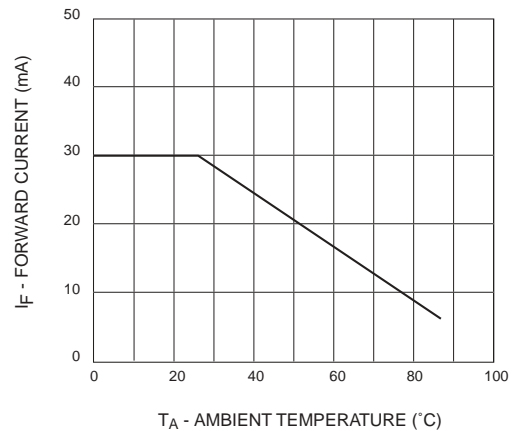
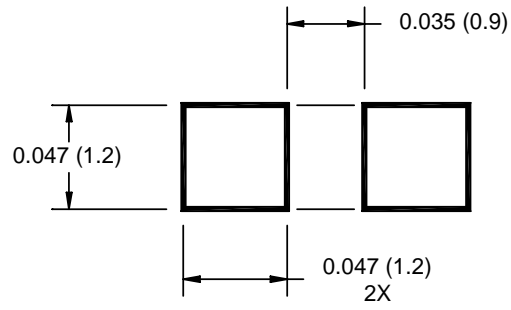

Fig.5 Maximum Forward Current vs. Ambient Temperature



Recommended Printed Circuit Board Pattern



Recommended IR Reflow Soldering Profile

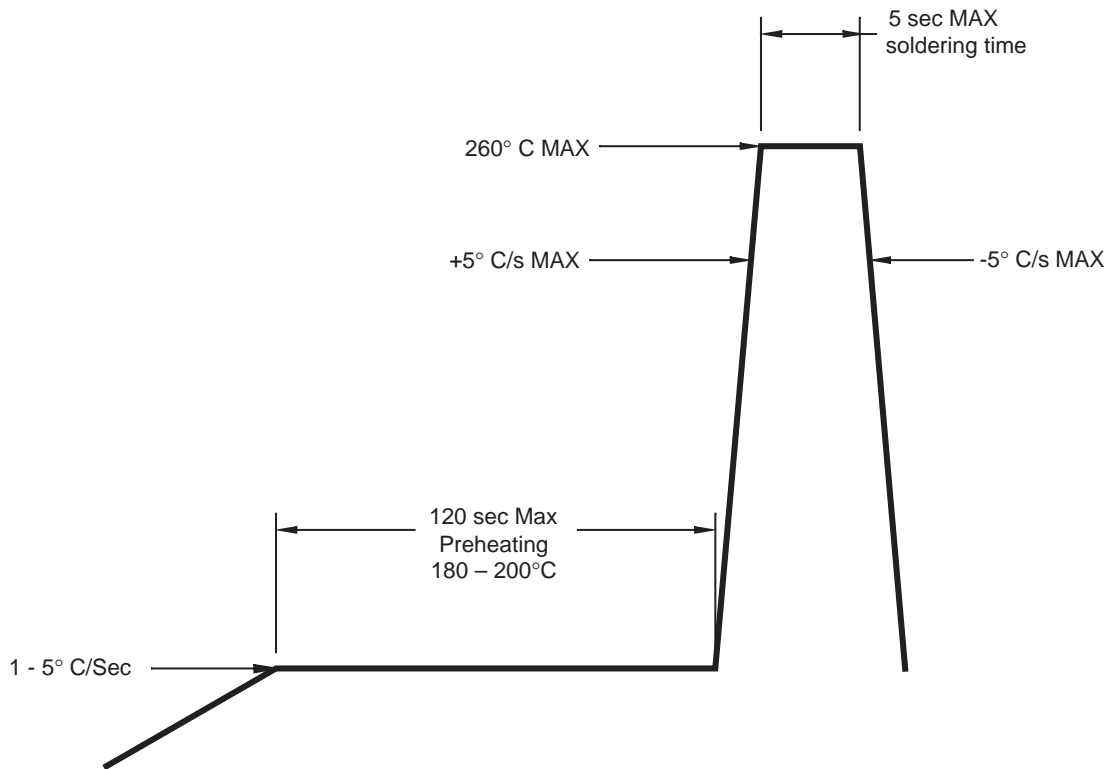

Tape and Reel Dimensions

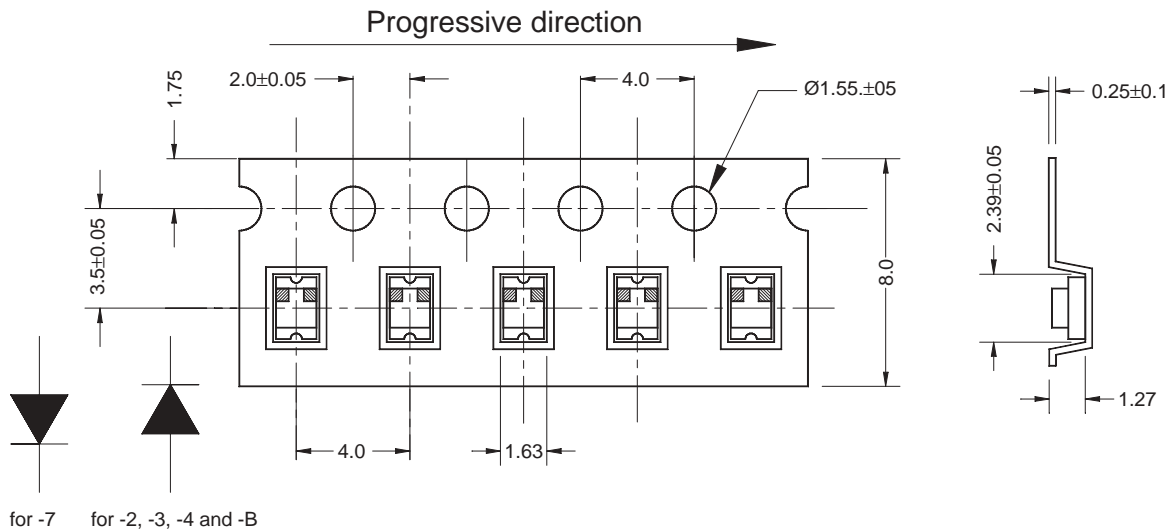
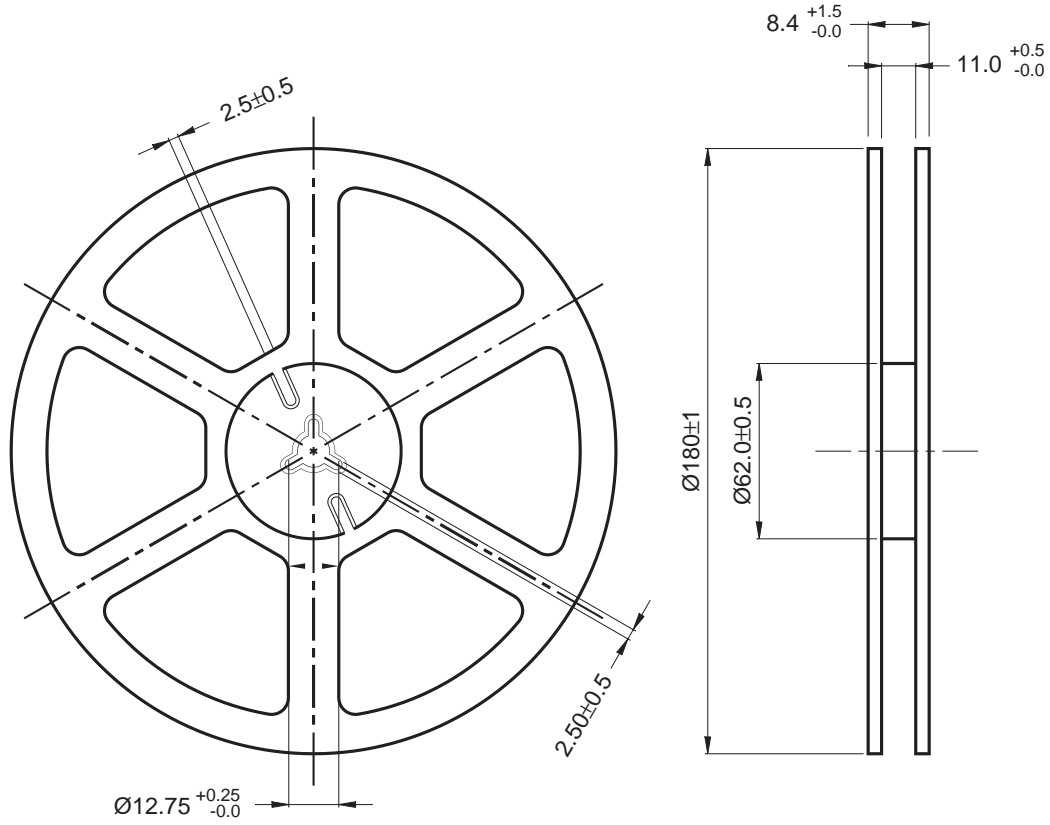

Polarity

Dimensional tolerance is ± 0.1 mm unless otherwise specified

Angle: ± 0.5

Unit: mm

TRADEMARKS

The following are registered and unregistered trademarks Fairchild Semiconductor owns or is authorized to use and is not intended to be an exhaustive list of all such trademarks.

ACEx™	FAST®	ISOPLANAR™	PowerSaver™	SuperSOT™-6
ActiveArray™	FASTr™	LittleFET™	PowerTrench®	SuperSOT™-8
Bottomless™	FPST™	MICROCOUPLER™	QFET®	SyncFET™
Build it Now™	FRFET™	MicroFET™	QS™	TinyLogic®
CoolFET™	GlobalOptoisolator™	MicroPak™	QT Optoelectronics™	TINYOPTO™
CROSSVOLT™	GTO™	MICROWIRE™	Quiet Series™	TruTranslation™
DOME™	HiSeC™	MSX™	RapidConfigure™	UHC™
EcoSPARK™	I ² C™	MSXPro™	RapidConnect™	UltraFET®
E ² CMOS™	i-Lo™	OCX™	μSerDes™	UniFET™
EnSigna™	ImpliedDisconnect™	OCXPro™	ScalarPump™	VCX™
FACT™	IntelliMAX™	OPTOLOGIC®	SILENT SWITCHER®	Wire™
FACT Quiet Series™		OPTOPLANAR™	SMART START™	
Across the board. Around the world.™		PACMAN™	SPM™	
The Power Franchise®		POP™	Stealth™	
Programmable Active Droop™		Power247™	SuperFET™	
		PowerEdge™	SuperSOT™-3	

DISCLAIMER

FAIRCHILD SEMICONDUCTOR RESERVES THE RIGHT TO MAKE CHANGES WITHOUT FURTHER NOTICE TO ANY PRODUCTS HEREIN TO IMPROVE RELIABILITY, FUNCTION OR DESIGN. FAIRCHILD DOES NOT ASSUME ANY LIABILITY ARISING OUT OF THE APPLICATION OR USE OF ANY PRODUCT OR CIRCUIT DESCRIBED HEREIN; NEITHER DOES IT CONVEY ANY LICENSE UNDER ITS PATENT RIGHTS, NOR THE RIGHTS OF OTHERS.

LIFE SUPPORT POLICY

FAIRCHILD'S PRODUCTS ARE NOT AUTHORIZED FOR USE AS CRITICAL COMPONENTS IN LIFE SUPPORT DEVICES OR SYSTEMS WITHOUT THE EXPRESS WRITTEN APPROVAL OF FAIRCHILD SEMICONDUCTOR CORPORATION. As used herein:

1. Life support devices or systems are devices or systems which, (a) are intended for surgical implant into the body, or (b) support or sustain life, or (c) whose failure to perform when properly used in accordance with instructions for use provided in the labeling, can be reasonably expected to result in significant injury to the user.
2. A critical component is any component of a life support device or system whose failure to perform can be reasonably expected to cause the failure of the life support device or system, or to affect its safety or effectiveness.

PRODUCT STATUS DEFINITIONS

Definition of Terms

Datasheet Identification	Product Status	Definition
Advance Information	Formative or In Design	This datasheet contains the design specifications for product development. Specifications may change in any manner without notice.
Preliminary	First Production	This datasheet contains preliminary data, and supplementary data will be published at a later date. Fairchild Semiconductor reserves the right to make changes at any time without notice in order to improve design.
No Identification Needed	Full Production	This datasheet contains final specifications. Fairchild Semiconductor reserves the right to make changes at any time without notice in order to improve design.
Obsolete	Not In Production	This datasheet contains specifications on a product that has been discontinued by Fairchild semiconductor. The datasheet is printed for reference information only.

Rev. 117