

185 W power supply with PFC and standby supply for LED TV using the L6564, L6599A, and Viper27LN

Introduction

This document describes the characteristics and features of a 185 W, wide input mains range, power-factor-corrected, demonstration board for LED TV.

The architecture is based on a three-stage approach: a front-end PFC pre-regulator based on the L6564 TM PFC controller and a downstream LLC resonant half bridge converter using the L6599A resonant controller, delivering 12 V, 24 V, and 130 V. A flyback-based standby supply delivering 5 V, controlled by the Viper27LN, is also implemented. Thanks to the chipset used, the principal factors of this design are the very high efficiency as well as the very low input consumption during standby operation.

Figure 1. EVL185W-LEDTV: 185 W demonstration board

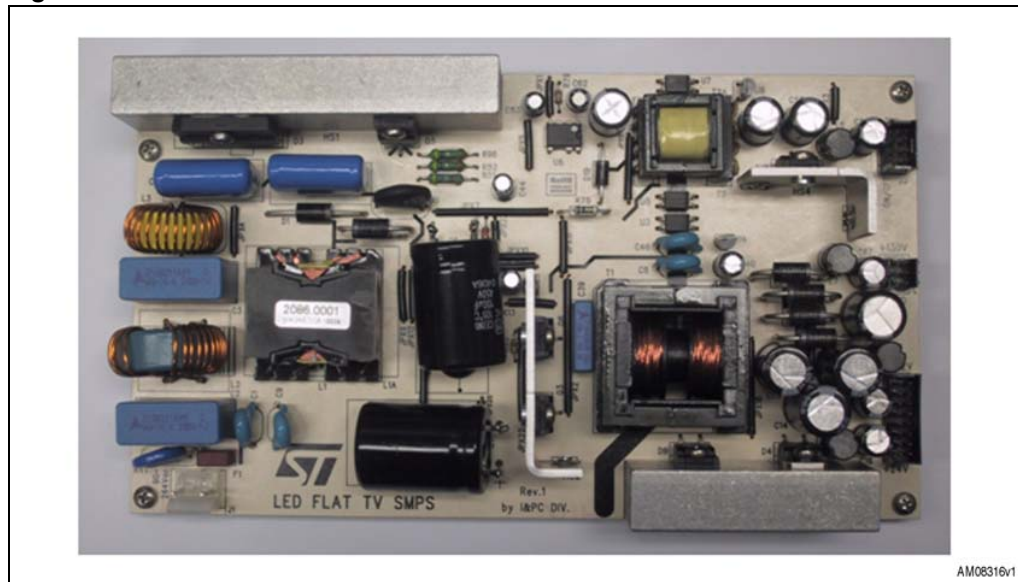

Contents

1	Main characteristics and circuit description	6
2	Efficiency measurement	10
3	Harmonic content measurement	12
4	Functional check	13
5	Thermal map	26
6	Conducted emission pre-compliance test	28
7	Bill of materials	29
8	PFC coil specification	36
9	Resonant power transformer specification	38
10	Flyback transformer specification	40
11	Revision history	42

List of tables

Table 1.	Overall efficiency measured at 230 Vac and 115 Vac mains voltage	10
Table 2.	Thermal maps reference points	27
Table 3.	Bill of materials	29
Table 4.	PFC coil winding data	36
Table 5.	Transformer winding data	38
Table 6.	Transformer winding data	40
Table 7.	Document revision history	42

List of figures

Figure 1.	EVL185W-LEDTV: 185 W demonstration board	1
Figure 2.	Electrical diagram	9
Figure 3.	Standby power supply efficiency	11
Figure 4.	Standby consumption	11
Figure 5.	EN61000-3-2 compliance at 230 Vac - 50 Hz, full load	12
Figure 6.	JEITA-MITI compliance at 100 Vac - 50 Hz, full load	12
Figure 7.	EN61000-3-2 compliance at 230 Vac - 50 Hz, 75 W	12
Figure 8.	JEITA-MITI compliance at 100 Vac - 50 Hz, 75 W	12
Figure 9.	Standby supply waveforms at 115 Vac - 60 Hz - full load	13
Figure 10.	Standby supply waveforms at 230 Vac - 50 Hz - full load	13
Figure 11.	Standby supply waveforms at 400 Vdc, full load	14
Figure 12.	Standby supply o/p rectifiers PIV at 400 Vdc, full load	14
Figure 13.	Standby supply 5 V ripple at 115 Vac - 60 Hz, full load	14
Figure 14.	Standby supply startup at 115 Vac - 60 Hz, full load	14
Figure 15.	Standby supply burst mode at 230 Vac - 50 Hz, 10 mA load	15
Figure 16.	Standby supply burst mode at 230 Vac, 10 mA load - detail	15
Figure 17.	Standby supply OVP at 115 Vac - 60 Hz, full load	16
Figure 18.	Standby supply OVP at 230 Vac - 50 Hz, full load	16
Figure 19.	Standby supply OVP at 115 Vac - 60 Hz, 0.5 A load	16
Figure 20.	Standby supply OVP at 115 Vac, 0.5 A load - detail	16
Figure 21.	Standby supply o/p short-circuit at 230 Vac - 50 Hz, full load	17
Figure 22.	Standby supply o/p short-circuit at 230 Vac, full load - detail	17
Figure 23.	Standby supply dynamic load at 115 Vac - 60 Hz - PFC off	17
Figure 24.	Standby supply dynamic load at 115 Vac - 60 Hz - PFC on	17
Figure 25.	PFC Vds and inductor current at 115 Vac - 60 Hz, full load	18
Figure 26.	PFC Vds and inductor current at 115 Vac, full load - detail	18
Figure 27.	PFC Vds and inductor current at 230 Vac - 50 Hz, full load	19
Figure 28.	PFC Vds and inductor current at 230 Vac, full load - detail	19
Figure 29.	L6564 signals (1) at 115 Vac - 60 Hz, full load	19
Figure 30.	L6564 signals (2) at 115 Vac - 60 Hz, full load	19
Figure 31.	Resonant stage waveforms at 115 Vac - 60 Hz, full load	20
Figure 32.	Resonant stage control signals at 115 Vac - 60 Hz, full load	20
Figure 33.	12 V and 24 V rectifier PIV	21
Figure 34.	130 V rectifier PIV	21
Figure 35.	Startup at full load and 115 Vac by on/off signal	21
Figure 36.	Shut down at full load and 115 Vac by on/off signal	21
Figure 37.	Startup at full load and 115 Vac by on/off signal - detail	22
Figure 38.	12 V load transition	23
Figure 39.	24 V load transition	23
Figure 40.	130 V load transition	23
Figure 41.	24 V current limitation at full load and 115 Vac - 60 Hz	24
Figure 42.	24 V short-circuit at full load and 115 Vac - 60 Hz	24
Figure 43.	12 V short-circuit at full load and 115 Vac - 60 Hz	24
Figure 44.	130 V short-circuit at full load and 115 Vac - 60 Hz	24
Figure 45.	OVP at full load and 115 Vac on 24 V output	25
Figure 46.	OVP at full load and 115 Vac on 12 V and 130 V outputs	25
Figure 47.	Half cycle mains dip at full load and 115 Vac - 60 Hz	25
Figure 48.	Full cycle mains dip at full load and 115 Vac - 60 Hz	25
Figure 49.	Thermal map at 115 Vac - 60 Hz, full load	26

Figure 50.	Thermal map at 230 Vac - 50 Hz, full load	26
Figure 51.	CE peak measurement at 115 Vac and full load	28
Figure 52.	CE peak measurement at 230 Vac and full load	28
Figure 53.	PFC coil electrical diagram	36
Figure 54.	PFC coil mechanical aspect	37
Figure 55.	Transformer electrical diagram	38
Figure 56.	Transformer overall drawing	39
Figure 57.	Flyback transformer electrical diagram	40
Figure 58.	Flyback transformer overall drawing	41

1 Main characteristics and circuit description

The main features of the SMPS are:

- Universal input mains range: 90 ÷ 264 Vac - frequency 45 ÷ 65 Hz
- Output voltage 1: 130 V ±8 % at 620 mA for backlight
- Output voltage 2: 24 V ±8 % at 2 A for audio supply
- Output voltage 3: 12 V ±1 % at 4 A for panel supply
- Output voltage 4: 5 V ±2 % at 2 A for microprocessor supply
- Mains harmonics: acc. to EN61000-3-2 Class-D or JEITA-MITI Class-D
- Standby mains consumption: <170 mW at 230 Vac with 50 mW load
- Overall efficiency at full load: >90 %
- EMI: acc. to EN55022-Class-B
- Safety: acc. to EN60065
- Dimensions: 115x204 mm, 25 mm maximum component height from PCB
- PCB: single side, 70 µm, CEM-1, mixed PTH/SMT

The circuit is made up of two sections: a 10 W standby supply delivering 5 V, dedicated to supplying the microprocessor and the logic circuitry, and a bigger section made up of a front-end PFC and an LLC resonant converter delivering three output voltages, 12 V is dedicated to supplying the TV panel, 24 V to supplying the audio power amplifiers and 130 V is dedicated to the backlight.

The PFC stage delivers 400 V constant voltage and acts as the pre-regulator for both the LLC stage and the standby supply.

An external signal, referred to secondary ground, turns the PFC and the LLC stage on and off.

Startup

At turn-on the standby supply begins startup and delivers 5 V dedicated to the TV microprocessor and other logic circuitry. It also generates the auxiliary voltage powering the PFC and LLC controllers at primary side via the linear regulator Q7. Q7 is activated by the optocoupler U5 that is driven by the logic signal on/off. At startup, the on/off signal (active high) from the microprocessor is supposed to be low, so the PFC and the LLC do not work.

Once the on/off signal is asserted high, the regulator Q7 delivers 14 V powering the PFC controller L6564 and the LLC controller L6599A; to always ensure proper operation of the LLC, the circuit is designed so that the PFC starts first, then the downstream converter. The LINE pin of L6599A allows the resonant stage to operate only if the PFC output is delivering its rated output voltage. It prevents the resonant converter from working with too low input voltage that can cause undesirable capacitive mode operation.

The L6599A LINE pin internal comparator has a hysteresis which allows to independently set the turn-on and turn-off voltage. The LLC turn-on voltage (PFC output) has been set to 380 V while the turn-off threshold has been set to 300 V. This last value avoids capacitive mode operation by the LLC stage but allows the resonant stage to operate even in the case of mains sag and consequent lowering of PFC output voltage.

Brownout protection

Brownout protection prevents the circuit from working with abnormal mains levels. It is achieved by two separate circuits, one using the brownout pin of the Viper and a second using an internal comparator of the L6564 dedicated to this function: this pin is internally connected to the VFF pin (#5) providing the information of the mains voltage peak value. The internal comparator allows the IC operations if the mains level is correct, within the nominal limits.

If the input voltage is below ~80 Vac (typ.), circuit startup is not allowed.

Resonant power stage

The downstream converter featuring the ST L6599A, incorporates all the functions necessary to properly drive the resonant converter with a 50 % fixed duty cycle and works with variable frequency.

The transformer, using the integrated magnetic approach and incorporating the resonant series inductance, delivers 3 output voltages without any post-regulator.

The transformer configuration chosen for the secondary winding delivering 12 V and 24 V output is center-tap and makes use of power Schottky rectifiers. For the secondary winding delivering 130 V, a full bridge configuration using four ultrafast diodes has been chosen. A small LC filter has been added on each output, to filter the high frequency ripple.

Output voltage feedback loop

The resonant stage feedback loop is implemented by means of a typical circuit using a TL431 modulating the current in the optocoupler diode. The three outputs are regulated by a weighted feedback control.

On the primary side, R37 - connecting the RFMIN pin (#4) to the optocoupler's phototransistor - closes the feedback loop and its value sets the maximum switching frequency. R36, connecting the same pin to ground, sets the minimum switching frequency. The RC series R22 and C21 sets both soft-start maximum frequency and duration.

L6599A overload and short-circuit protection

The current into the primary winding is sensed by the loss-less circuit R53, C36, D14, D12, R55, and C38, and is fed into the ISEN pin (#6). In the case of overcurrent, the voltage on the pin overpass the internal comparator threshold (0.8 V), triggering a protection sequence. The capacitor (C37) connected to the DELAY pin (#2) is charged by an internal 150 μ A current generator and is slowly discharged by the resistor R54. This pin is connected to the DIS pin and as soon as the voltage achieves 1.85 V, the IC stops switching latched. On/off signal recycling is necessary to restart the resonant converter.

Overvoltage and open loop protection

Both PFC and resonant stages are equipped with their own overvoltage protection.

The PFC controller L6564 monitors its output voltage via the resistor divider connected to the PFC_OK pin (#6) protecting the circuit in case of loop failures, disconnection, or deviation from the nominal value of the feedback loop divider. When a fault condition is detected, by monitoring both PFC_OK and INV pins, the PFC_OK circuitry latches the L6564 operations. The PFC is kept latched until the mains voltage is recycled.

In the case of overvoltage by the resonant stage the Zener diodes D16, D17, and D29 detect the output voltages and conduct. This causes Q10 to turn on and, consequently, Q9

also turns on. These two transistors form an SCR structure that shorts to ground the anode of the U5 optocoupler in case of an overvoltage event. In this way, Q7 cannot deliver supply voltage Vcc to the controller which remains latched until the mains voltage is recycled.

To protect the PFC and LLC controllers from being powered with an abnormal voltage, which may occur in the case of a failure of the regulator based on Q7, an overvoltage protection is provided by the Zener diode D13. In the case of the Q7 regulator providing an excessive output voltage, D13 is reverse-biased and latches the L6599A through the DIS pin (#8).

Figure 2. Electrical diagram

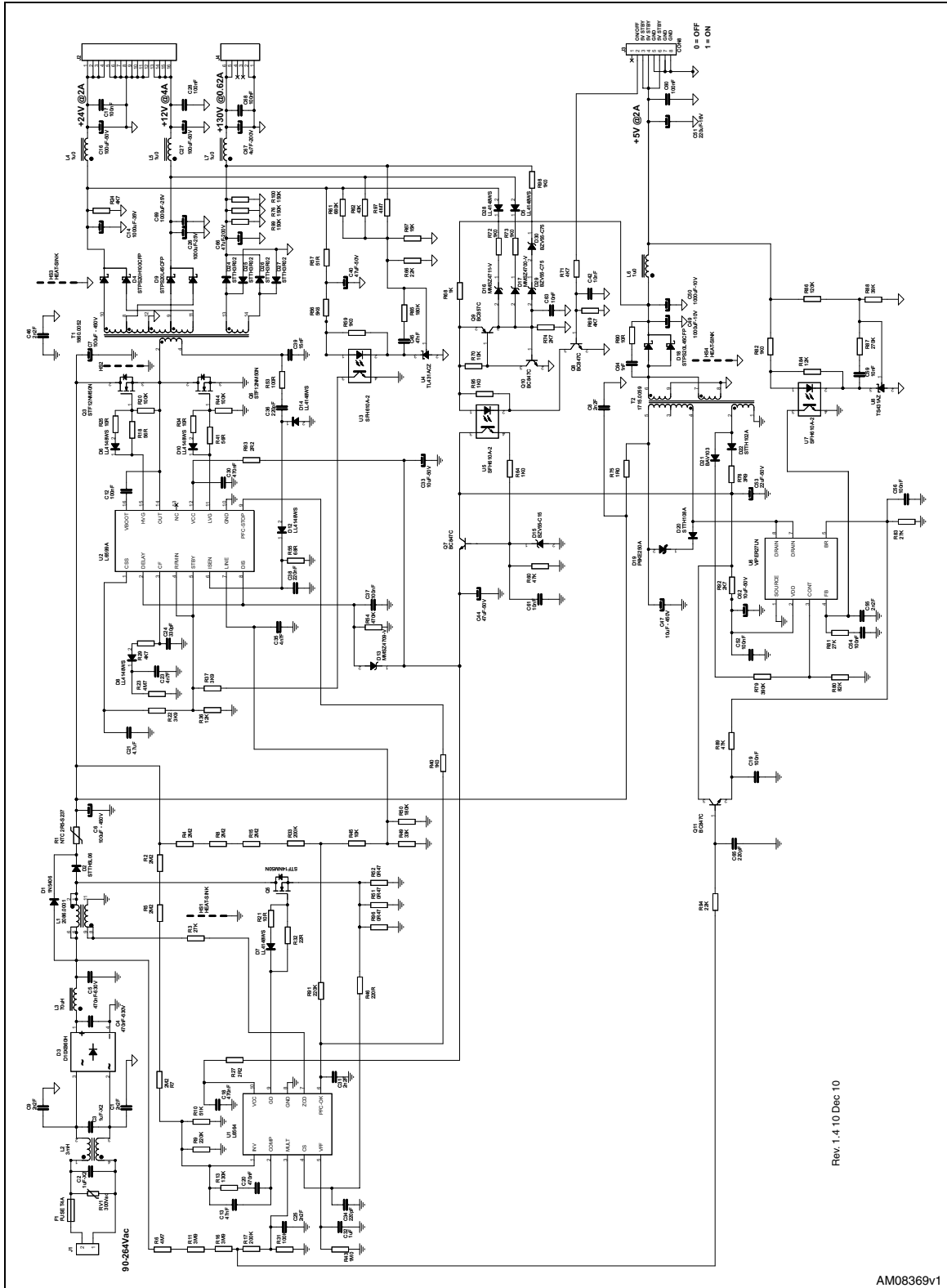

2 Efficiency measurement

Table 1 and *2* show the overall efficiency, measured at both nominal mains voltages. At 230 Vac the full load efficiency is 93.3 % and at 115 Vac it is 90.8 %. Average efficiency measured at 25 %, 50 %, 75 %, and 100 % of nominal load is higher than 90 %.

The average efficiency has been calculated according to ENERGY STAR® 2.0 criteria. Results are summarized in the following figures.

Table 1. Overall efficiency measured at 230 Vac and 115 Vac mains voltage

Test	230 V - 50 Hz										
	12 V		24 V		130 V		5 V		Pout[W]	Pin[W]	Eff.[%]
	Vout [V]	Iout [A]	Vout [V]	Iout [A]	Vout [V]	Iout [A]	Vout [V]	Iout [A]			
25 % load eff.	11.95	1.00	24.19	0.50	128.89	0.15	5.05	0.50	46.09	52.00	88.6
50 % load eff.	11.93	2.01	24.28	1.00	129.95	0.31	5.04	1.00	93.30	101.50	91.9
75 % load eff.	11.90	3.01	24.38	1.50	131.05	0.47	5.04	1.50	141.67	151.90	93.3
100 % load eff.	11.88	3.99	24.48	2.00	132.18	0.62	5.04	2.00	187.96	201.50	93.3
Average eff.											91.8
Test	115 V - 60 Hz										
	12 V		24 V		130 V		5 V		Pout[W]	Pin[W]	Eff.[%]
	Vout [V]	Iout [A]	Vout [V]	Iout [A]	Vout [V]	Iout [A]	Vout [V]	Iout [A]			
25 % load eff.	11.95	1.00	24.19	0.50	128.89	0.15	5.05	0.50	46.09	52.35	88.0
50 % load eff.	11.93	2.01	24.28	1.00	129.95	0.31	5.04	1.00	93.30	102.85	90.7
75 % load eff.	11.90	3.01	24.38	1.50	131.05	0.47	5.04	1.50	141.67	154.92	91.4
100 % load eff.	11.87	3.99	24.47	2.00	132.15	0.62	5.04	2.00	187.76	206.84	90.8
Average eff.											90.2

Standby supply efficiency

Standby power supply efficiency has been measured and the results are plotted in [Figure 3](#). As shown, the efficiency during rated load operation is better than 82 %, at both nominal mains voltages from 50 % to full load.

[Figure 4](#) shows consumption at very light load, such as microprocessor and wake-up circuitry. This measurement is representative of the significant low consumption from the mains required for microprocessor powering. It should be mentioned that the standby supply efficiency has been calculated measuring the input power at the input connector, including power loss contribution due to all residual loads connected to mains before and after the input bridge rectifier, such as the EMI filter and PFC dividers.

Figure 3. Standby power supply efficiency

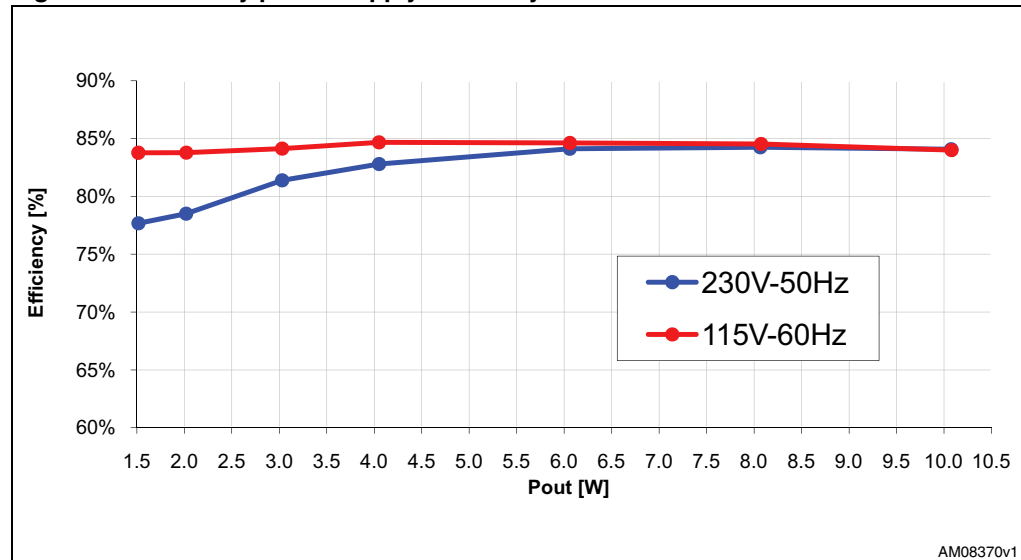
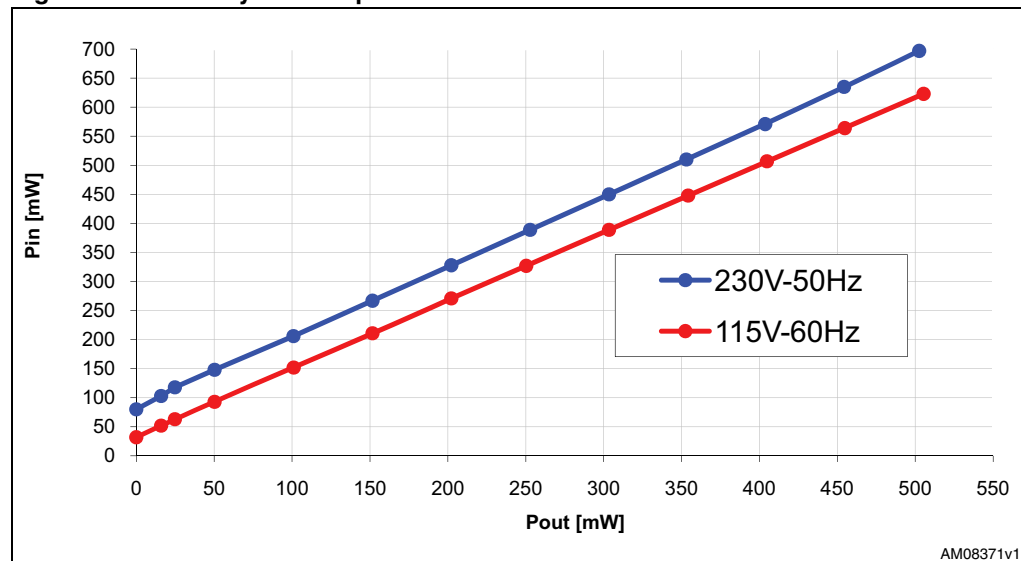

Figure 4. Standby consumption



3 Harmonic content measurement

The main purpose of a PFC pre-regulator is the input current shaping to reduce the harmonic content below the limits of the relevant regulations. This demonstration board has been tested according to the European standard EN61000-3-2 Class-D and Japanese standard JEITA-MITI Class-D, at full load and 75 W input power.

Figure 5, 6, 7, and 8 show the test results. As can be seen, the PFC is able to reduce the harmonics well below the limits of both regulations in all conditions. Total harmonic distortion (THD) and power factor (PF) values are given below each diagram.

Figure 5. EN61000-3-2 compliance at 230 Vac - 50 Hz, full load

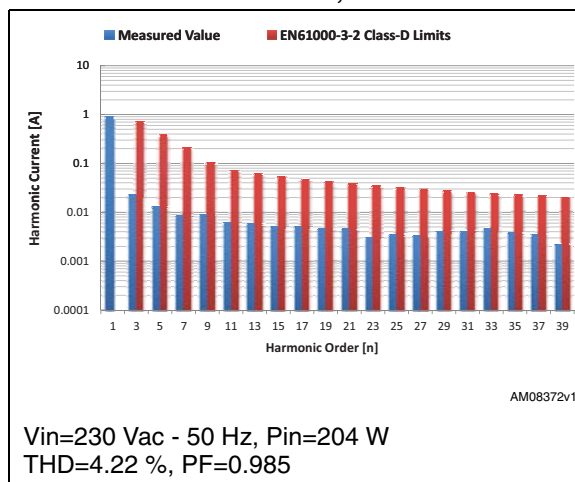

Figure 6. JEITA-MITI compliance at 100 Vac - 50 Hz, full load

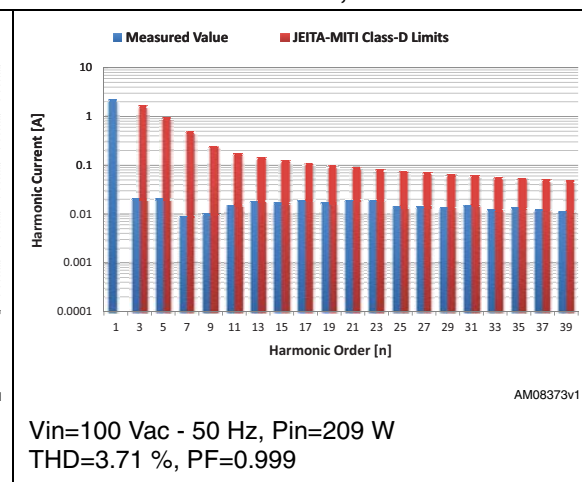

Figure 7. EN61000-3-2 compliance at 230 Vac - 50 Hz, 75 W

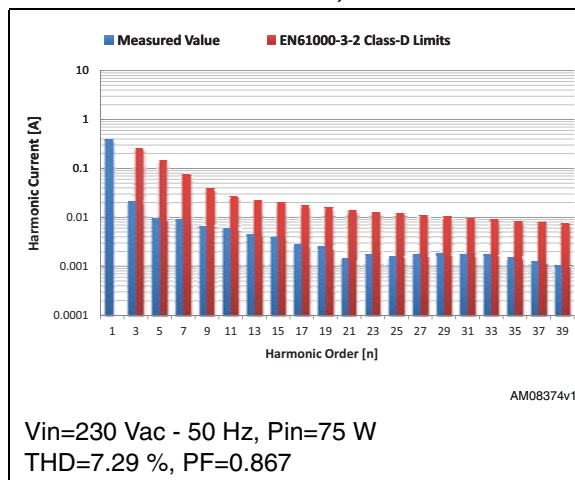
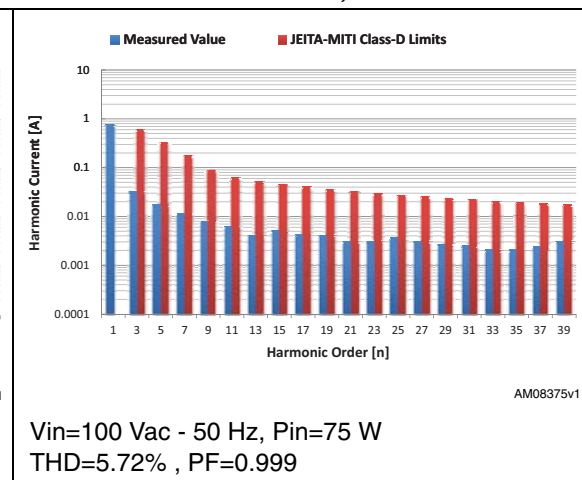

Figure 8. JEITA-MITI compliance at 100 Vac - 50 Hz, 75 W



4 Functional check

Standby supply

In [Figure 9](#) and [10](#) some waveforms of the standby supply under rated load operation are reported. It is based on the Viper27LN, a device integrating the controller and MOSFET in a single DIP-7 package. The Viper27LN works with fixed switching frequency at about 60 kHz, with frequency jittering to reduce EMI. In order to obtain a good efficiency and to reduce transformer size the converter has been designed to operate in continuous conduction mode at low mains ([Figure 9](#)) and discontinuous conduction mode at high mains ([Figure 10](#)) if PFC and resonant are not working.

Figure 9. Standby supply waveforms at 115 Vac - 60 Hz - full load

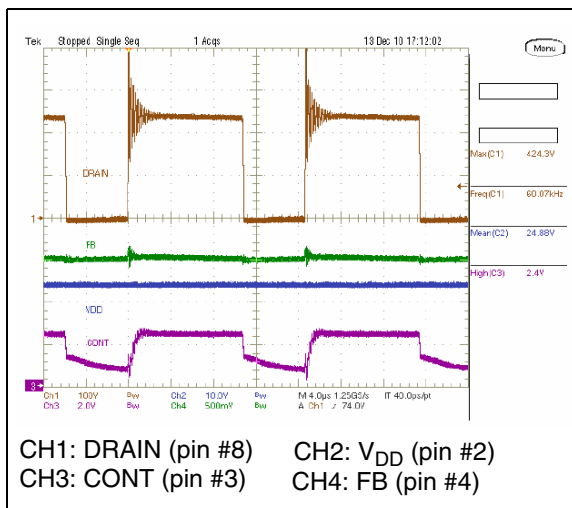
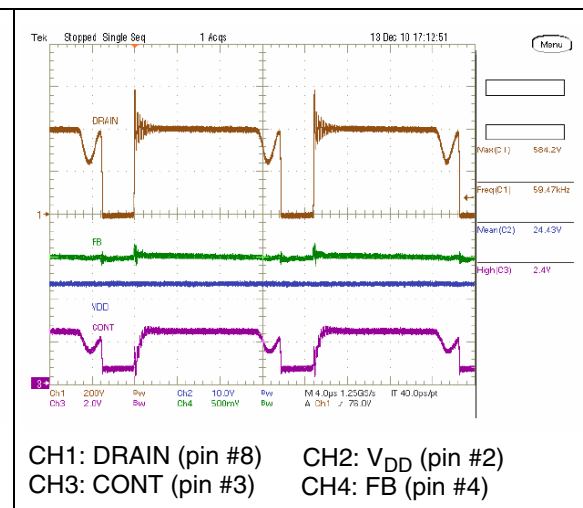

Figure 10. Standby supply waveforms at 230 Vac - 50 Hz - full load



In [Figure 11](#) the converter waveforms are captured once the PFC is working. The small value of the standby transformer leakage inductance allows limited dissipation on the clamping network across the primary winding. In addition, the drain peak voltage is well below the Viper27LN rating even with maximum input voltage and full load operation.

Waveforms relevant to the secondary side are represented in [Figure 12](#): the maximum reverse voltages applied to the rectifier are well below the component maximum ratings.

Figure 11. Standby supply waveforms at 400 Vdc, full load

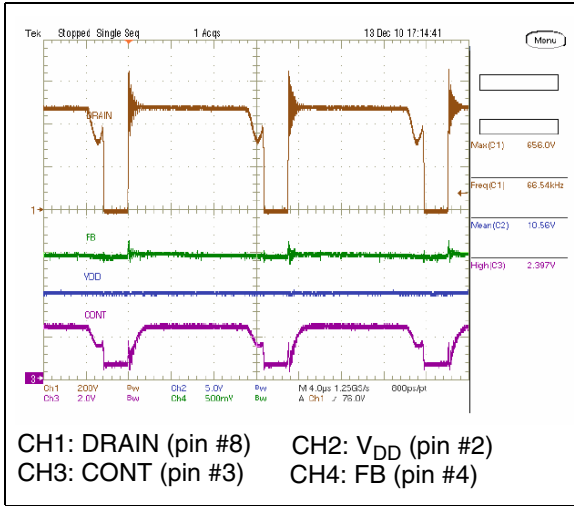
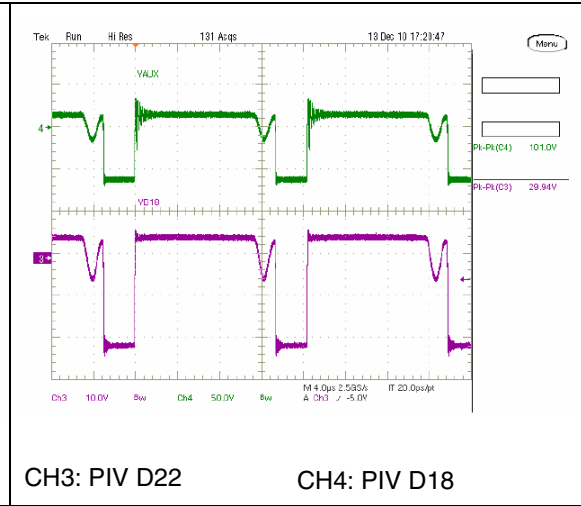

Figure 12. Standby supply o/p rectifiers PIV at 400 Vdc, full load



In *Figure 13* the 5 V output voltage ripple has been captured during operation at 115 Vac of the standby converter only. Ripple and noise measured at full load are very limited.

Figure 14 shows the waveforms during the startup of only the standby converter at full load. At power-on, the Viper27LN internal startup current source charges the Vcc capacitor until voltage increases up to the turn-on threshold. At this point the Viper27LN starts operating and the output voltage reaches the nominal value. During the converter startup the Viper27LN internal digital fixed time-based (8.5 ms) soft-start limits the drain current which gradually increases to the maximum value. In this way the stress on the secondary diode is considerably reduced and transformer saturation is prevented. The brownout circuits prevent the Viper27LN from operating if the input voltage is too low.

Figure 13. Standby supply 5 V ripple at 115 Vac - 60 Hz, full load

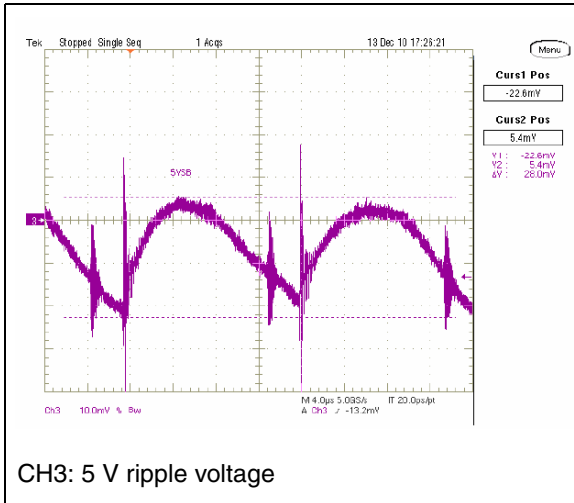
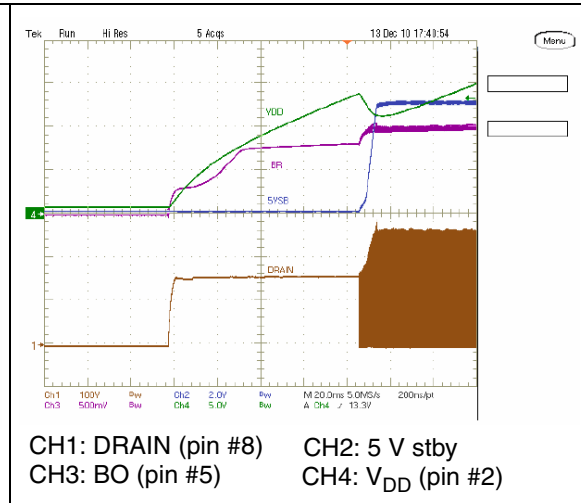

Figure 14. Standby supply startup at 115 Vac - 60 Hz, full load



In [Figure 15](#) and [16](#) light load operation waveforms have been captured. Viper27LN operates in burst mode, with just a few pulses by each burst, minimizing switching losses and obtaining a significant efficiency, under light load operation, making it suitable for equipment with very low standby consumption requirements.

Figure 15. Standby supply burst mode at 230 Vac - 50 Hz, 10 mA load

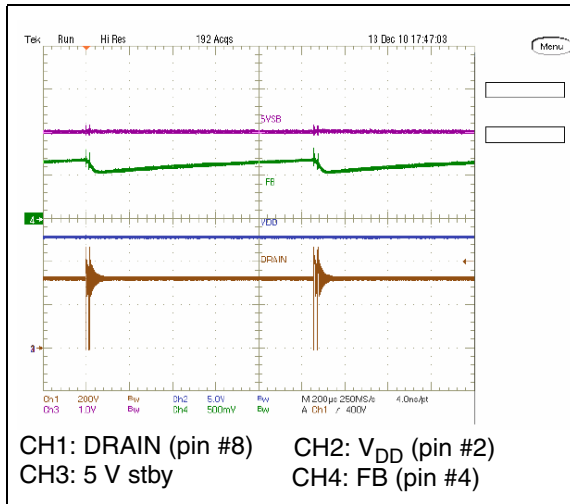
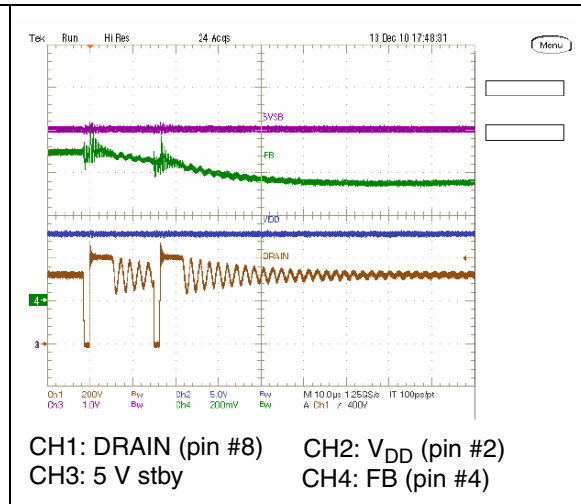

Figure 16. Standby supply burst mode at 230 Vac, 10 mA load - detail



[Figure 17](#), [18](#), [19](#), and [20](#) show overvoltage protection response, simulated by opening the Viper27LN feedback loop. When the output voltage value exceeds the internal threshold set by the divider connected to the CONT pin (#3), the Viper27LN stops operation providing protection against the generation of dangerous voltages which could damage the circuitry. The Viper27LN operation is latched until the V_{DD} has dropped down to V_{DD_RESTART} (4.5 V). At this point the internal current source charges the V_{DD} capacitor until it reaches the V_{DDon} and the Viper27LN starts again via a soft-start cycle.

If the overvoltage condition continues, a new protection cycle takes place, until the failure cause is removed. It is important to highlight that the Viper27LN OVP protection ensures a stable intervention point, independent of the output load, even if the voltage sensing is done on auxiliary winding at primary side.

Figure 17. Standby supply OVP at 115 Vac - 60 Hz, full load

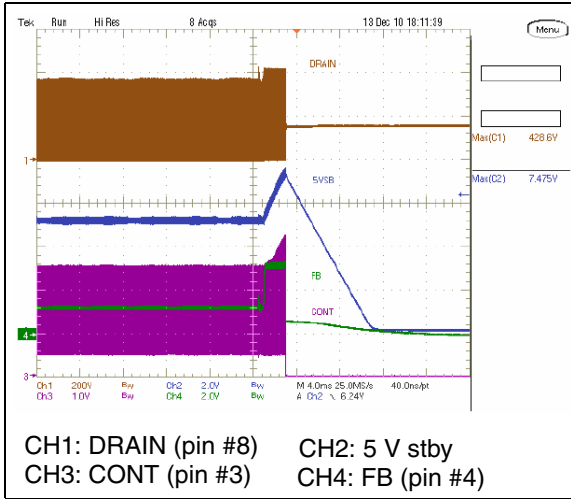

Figure 18. Standby supply OVP at 230 Vac - 50 Hz, full load

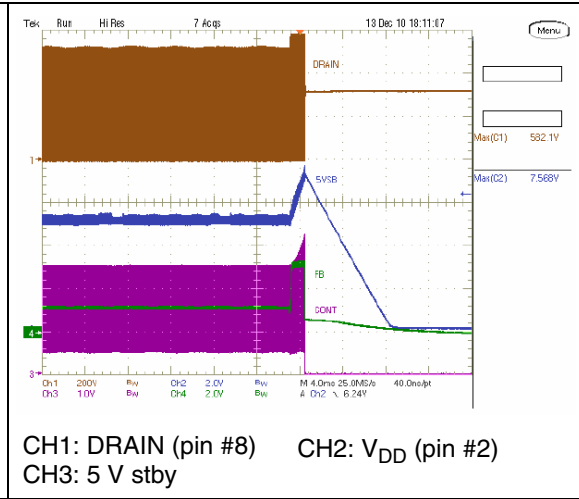

Figure 19. Standby supply OVP at 115 Vac - 60 Hz, 0.5 A load

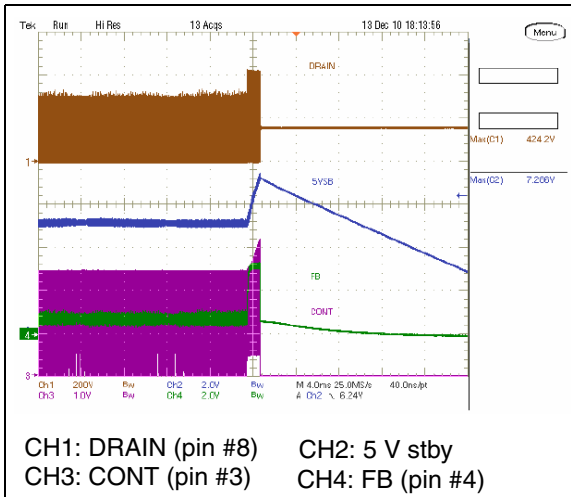
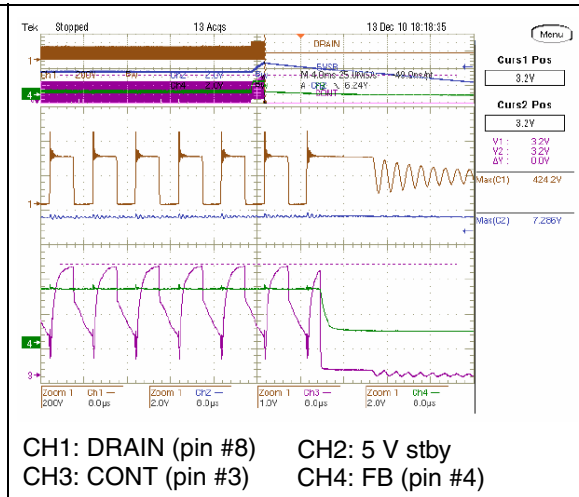

Figure 20. Standby supply OVP at 115 Vac, 0.5 A load - detail



In [Figure 21](#) and [22](#) a short-circuit event has been captured. In this situation the Viper27LN works in hiccup mode, protecting the standby converter power components against overheating. At short detection, the device internal circuitry stops the auxiliary converter operation until the V_{DD} has dropped down to $V_{DD_RESTART}$.

Then the internal current source charging the V_{DD} capacitor is activated until the V_{DDon} has been reached, when the Viper27LN restarts switching. Hiccup cycles are repeated as long as the short-circuit condition exists. The IC resumes normal operation only at short-circuit removal.

Figure 21. Standby supply o/p short-circuit at 230 Vac - 50 Hz, full load

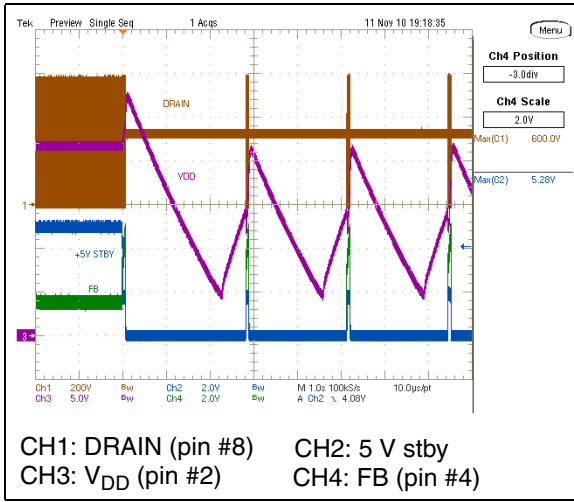
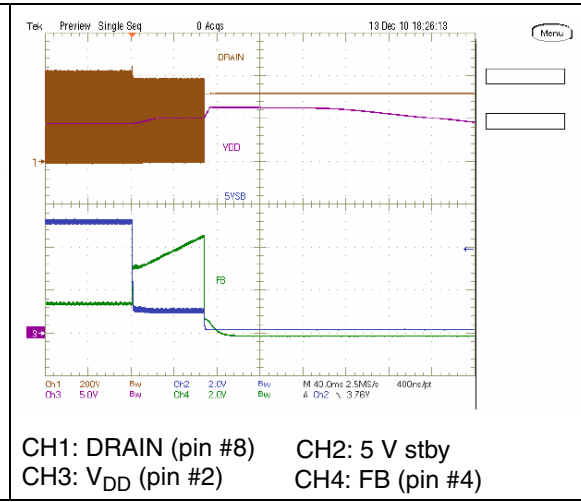

Figure 22. Standby supply o/p short-circuit at 230 Vac, full load - detail



In *Figure 23* and *24* the transitions from full load to no load and vice versa at maximum input voltage have been checked. The most critical situation is when the PFC stage is operating, as during no load operation the burst pulses have the lowest repetition rate, due to higher input voltage, and the V_{DD} might drop below V_{DDoff} (8 V typ.), causing the controller to shut down. As seen in the figures, both transitions are clean and there isn't any output voltage or V_{DD} dip.

Figure 23. Standby supply dynamic load at 115 Vac - 60 Hz - PFC off

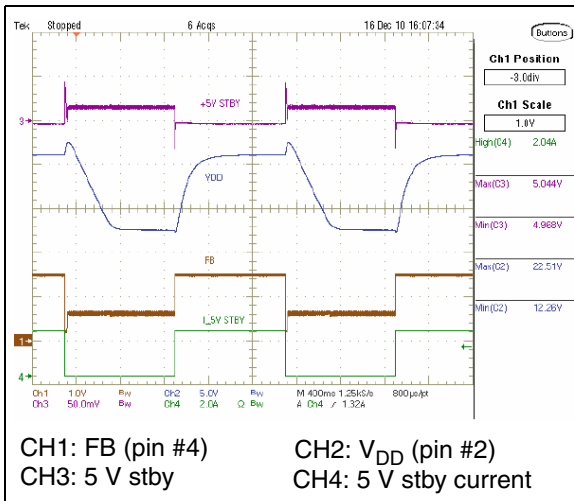
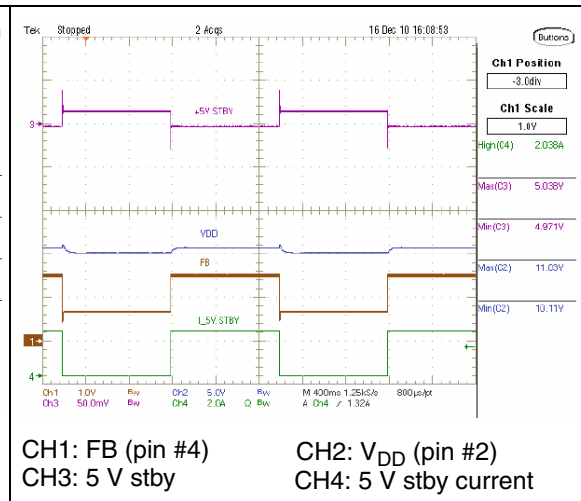

Figure 24. Standby supply dynamic load at 115 Vac - 60 Hz - PFC on



Power factor corrector stage

Figure 25 and 26 show some waveforms of the PFC stage under full load operation. THD is considerably reduced due to the L6564 highly linear multiplier, along with a special correction circuit that reduces crossover distortion of the mains current. Figure 25 shows waveforms along a line half-period at 115 Vac. Current shaping is achieved as both CS signal and peak inductor current are modulated according to the MULT signal, which is proportional to the input voltage.

Figure 26 represents a detail of the signals in Figure 25; the MOSFET is turned on as the inductor current reaches zero, obtaining transition mode (TM) operation. As the input voltage is lower than voltage across inductor, ZVS (zero voltage switching) is achieved.

Figure 25. PFC Vds and inductor current at 115 Vac - 60 Hz, full load

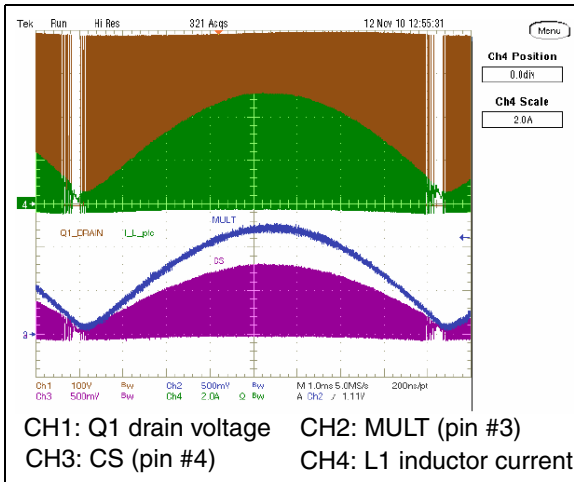

Figure 26. PFC Vds and inductor current at 115 Vac, full load - detail

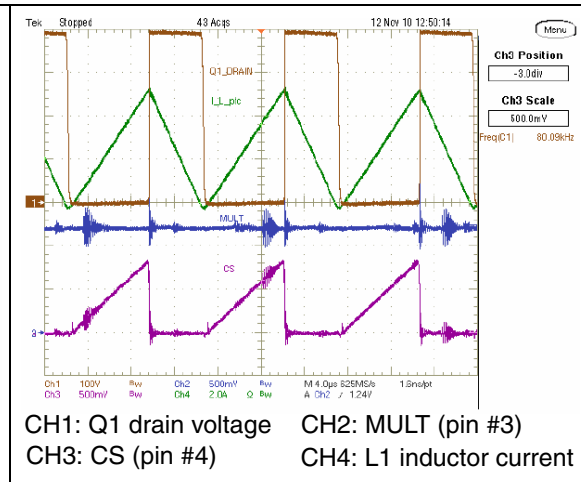

Figure 27 and 28 show PFC waveforms at full load at 230 Vac. It is possible to observe that the boost inductor resonance with the total drain capacitance, with an amplitude of twice the inductor voltage, on the offset of input voltage. Contrary to operation at 115 Vac, the MOSFET is turned on when there is still voltage on its drain but TM operation assures valley switching, minimizing switching losses.

Figure 27. PFC Vds and inductor current at 230 Vac - 50 Hz, full load

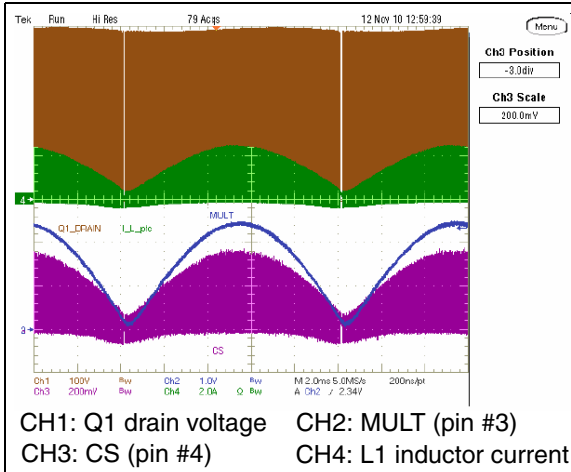

Figure 28. PFC Vds and inductor current at 230 Vac, full load - detail

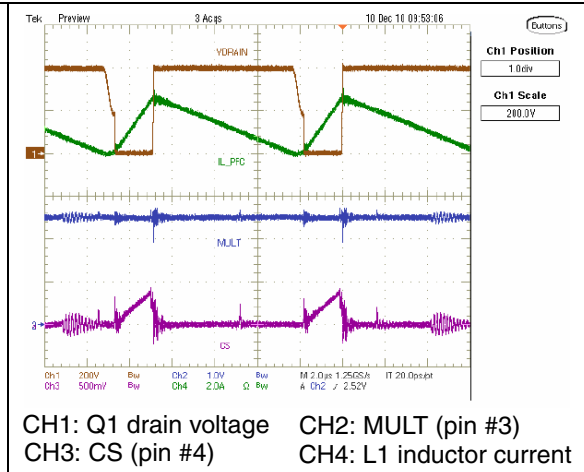
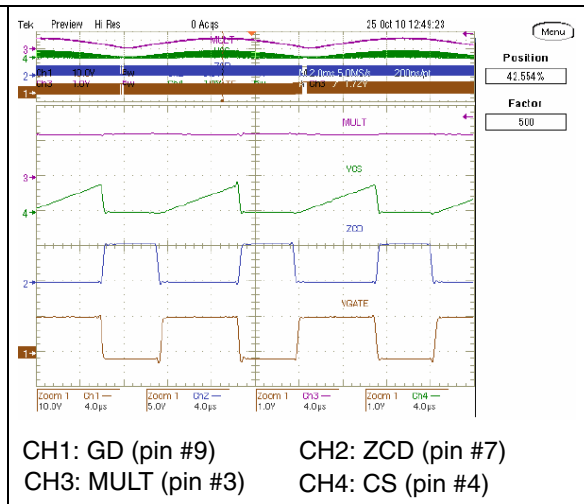
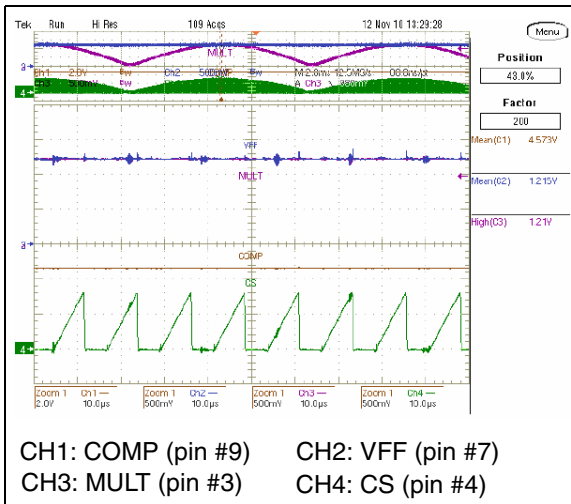

Figure 29 and 30 show the PFC control signal; in particular the VFF signal which is the second input to the multiplier for 1/√2 function. The voltage at this pin, a DC level equal to the peak voltage on the MULT pin (#3), compensates the control loop gain line-dependence.

In Figure 30, it can be observed that a negative-going edge on the ZCD pin triggers the MOSFET turn-on.

Figure 29. L6564 signals (1) at 115 Vac - 60 Hz, full load **Figure 30. L6564 signals (2) at 115 Vac - 60 Hz, full load**



Resonant stage

Figure 31 and *32* show some waveforms relevant to the resonant stage during steady-state operation. The selected switching frequency is about 110 kHz, in order to have a good trade-off between transformer losses and size. The converter operates slightly below the resonance frequency. *Figure 31* shows the resonant ZVS operation: both MOSFETs are turned on when resonant current is flowing through their body diodes and drain-source voltage is zero. *Figure 32* shows the L6599A control signals. The oscillator signal is clean from noise and symmetrical ensuring proper HB driving.

Figure 31. Resonant stage waveforms at 115 Vac - 60 Hz, full load

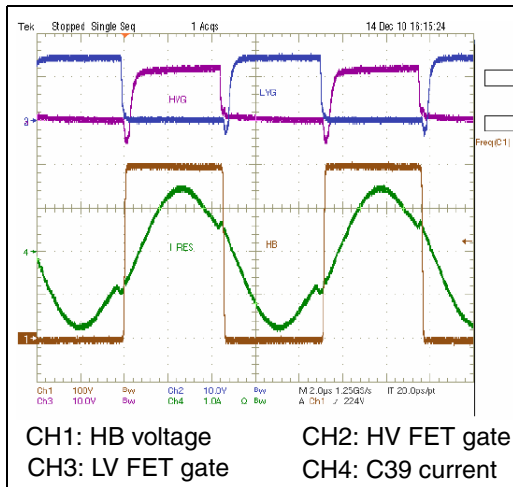
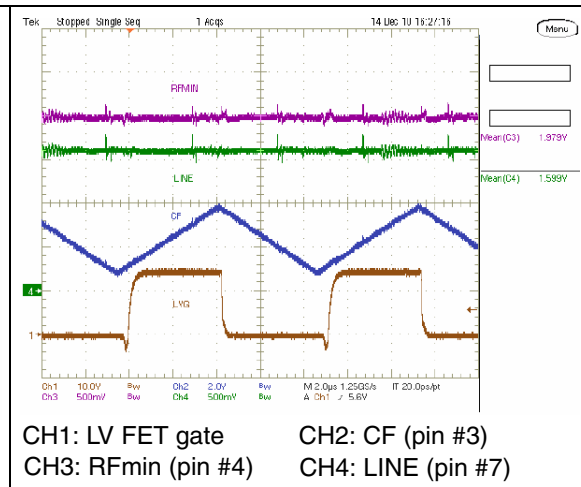

Figure 32. Resonant stage control signals at 115 Vac - 60 Hz, full load



In *Figure 33* and *34* reverse voltages across output rectifiers have been captured. The maximum voltages applied to the rectifier are well below the components maximum ratings. Because 12 V and 24 V outputs are obtained by center-tap secondary configuration, reverse voltages applied to the respective rectifiers are almost twice the output voltage. On the other hand, 130 V output is obtained by full bridge rectification and voltages across rectifiers correspond to output voltage.

Figure 33. 12 V and 24 V rectifier PIV

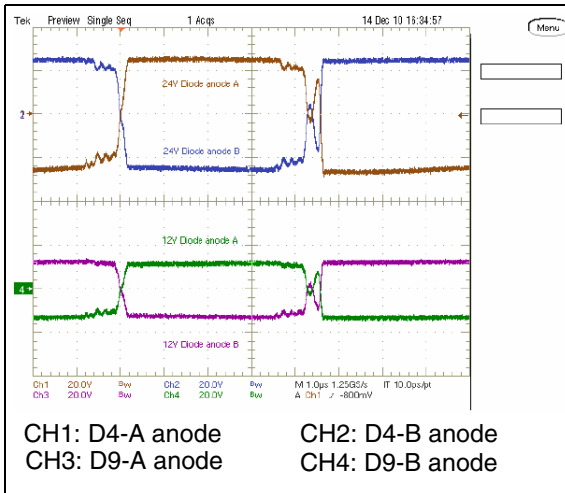

Figure 34. 130 V rectifier PIV

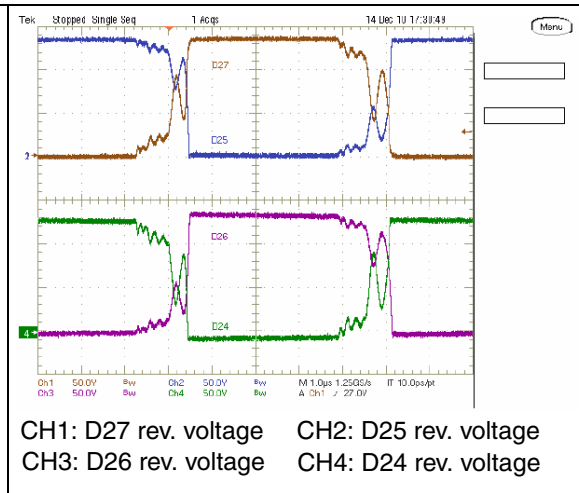

Figure 35 shows the waveforms during startup at 115 Vac and full load. Note the sequence of the two stages: the PFC starts and its output voltage increases from the mains rectified voltage to its nominal value. In the meantime, the L6599A is kept inactive by the LINE pin (#7) until the PFC voltage reaches the set threshold. Then, the resonant starts operating and the output voltage reaches the nominal level. Output voltage achieves the nominal value 150 ms after power-on signal.

Figure 36 shows the waveforms at shutdown. Opening the on/off signal, both L6564 and L6599A are no longer supplied. Output voltage drops to 0 V 40 ms after power off signal.

Figure 35. Startup at full load and 115 Vac by on/off signal

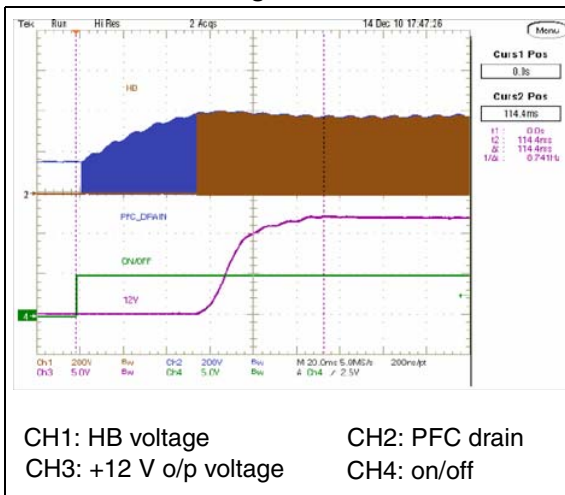

Figure 36. Shut down at full load and 115 Vac by on/off signal

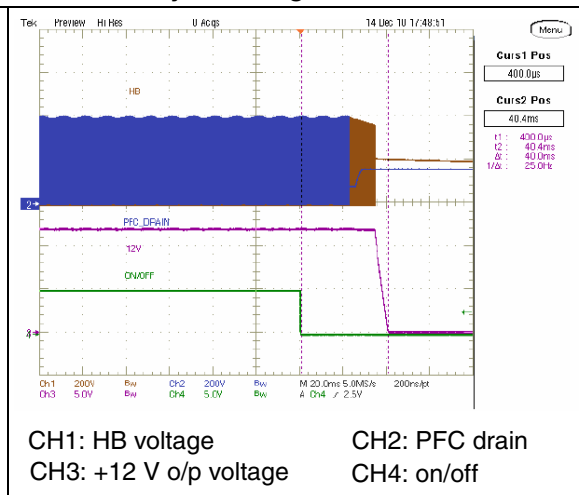
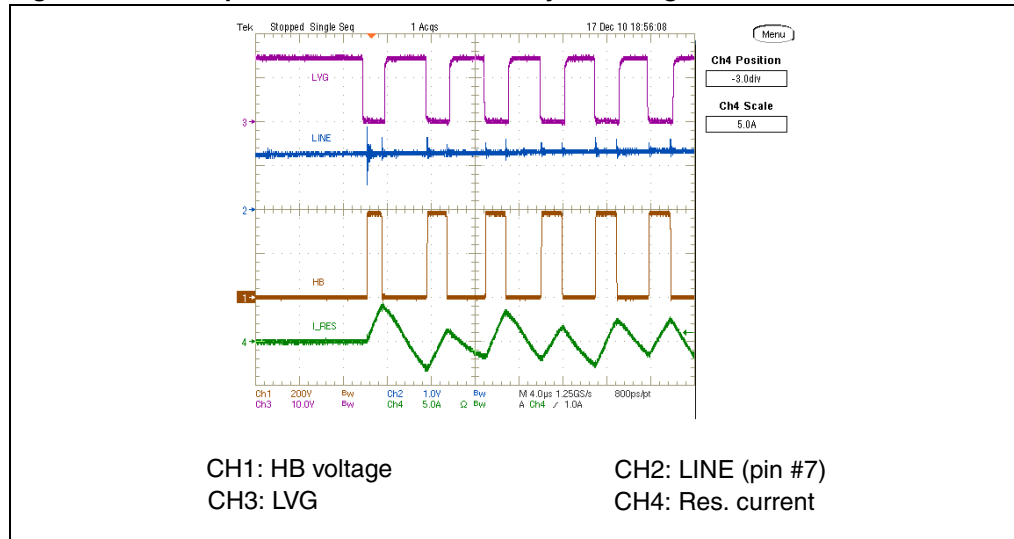

Figure 37 shows details of waveforms at startup. Note that the resonant current at turn-on has some oscillations due to the charging of the resonant elements. Anyhow, current zero-crossing always lags the HB commutations and consequently the MOSFETs are soft-switched.

Figure 37. Startup at full load and 115 Vac by on/off signal - detail



Output cross regulation has been checked. Resonant feedback signal is obtained by sensing all three outputs. Therefore, any load change relevant to any output could affect the other output regulation. The following figures show the effect of load transient on any of the output loads.

[Figure 38](#) shows output regulation in the case of 12 V load transient from 50 % to maximum load and vice versa. Because the 12 V output is dedicated to TV panel supply, 50 % of nominal load is assumed as the minimum load.

[Figure 39](#) shows output regulation in the case of 24 V load transient from minimum to maximum functional load and vice versa. The 24 V output is dedicated to the audio supply and load transient is from 0 % to 100 % of nominal load.

[Figure 40](#) shows output regulation in the case of 130 V load transient from minimum to maximum functional load and vice versa. The 130 V output is dedicated to supplying the LED backlight. A residual 1 W load is assumed for backlight circuitry driving even at minimum load.

The maximum measured voltage deviation for 12 V output is 200 mV, for 24 V it is 400 mV and for 130 V it is 2 V.

Figure 38. 12 V load transition

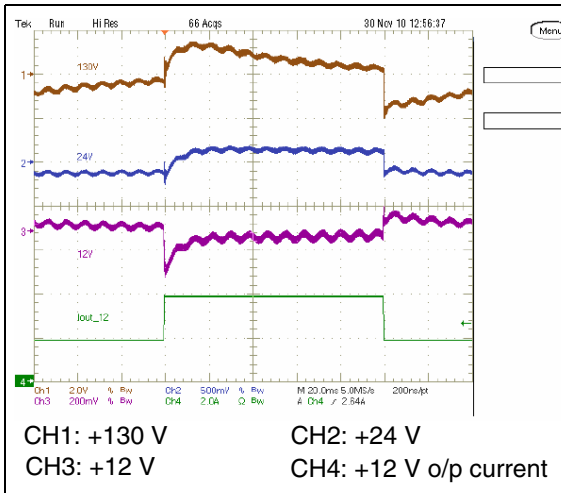

Figure 39. 24 V load transition

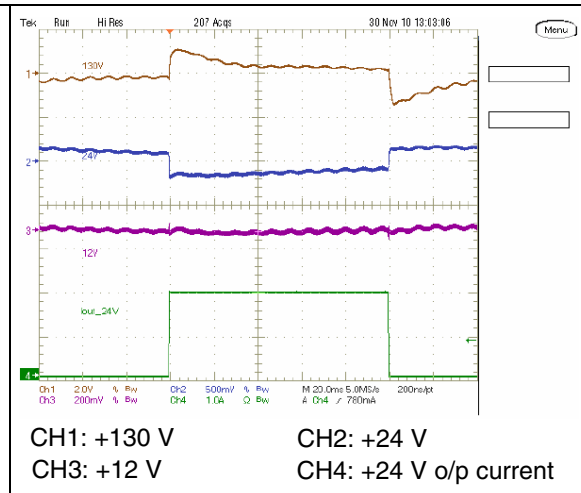
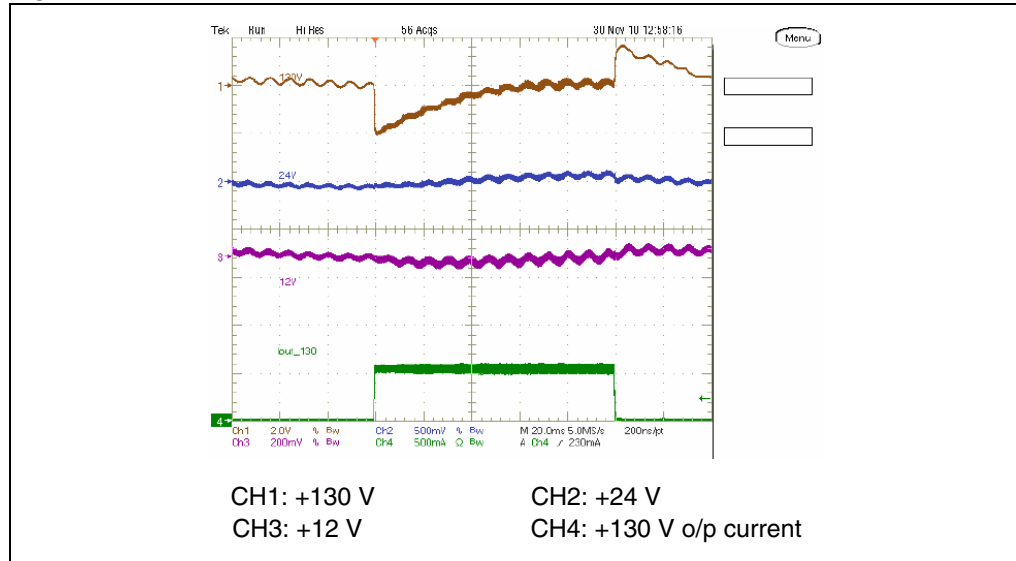

Figure 40. 130 V load transition



The L6599A is equipped with a current sensing input (pin #6, ISEN) and a dedicated overcurrent management system. The current flowing in the resonant tank is detected and the signal is fed into the ISEN pin. It is internally connected to a first comparator referenced to 0.8 V, and to a second comparator referenced to 1.5 V. [Figure 41](#) shows an example of overload occurrence. If the voltage externally applied to ISEN exceeds 0.8 V, an internal switch is turned on and discharges the soft-start capacitor CSS. This operation results in a nearly constant peak primary current limiting the output power. At the same time, an internal 150 μ A current generator, which, via the DELAY pin, charges C37, is activated. Because the DELAY and DIS pins short each other, if the voltage on C37 reaches 1.85 V, the L6599A stops switching and the PFC_STOP pin is pulled low disabling also the PFC.

An off-on recycle is necessary to restart the converter. By dimensioning C37 and R54, the designer can set the maximum time that the converter is allowed to run overloaded or under short-circuit conditions. Overloads or short-circuits lasting less than the set time do not

cause IC shutdown, therefore providing the system with immunity to short duration phenomena. If, instead, the overload condition continues, the mentioned procedure for shutting down the L6599A is activated. *Figure 42, 43, and 44* show dead short events on 24 V, 12 V, and 130 V outputs respectively; the voltage on ISEN reaches the second comparator threshold, the L6599A immediately shuts down and the operation is resumed after an off-on cycle.

Figure 41. 24 V current limitation at full load and 115 Vac - 60 Hz

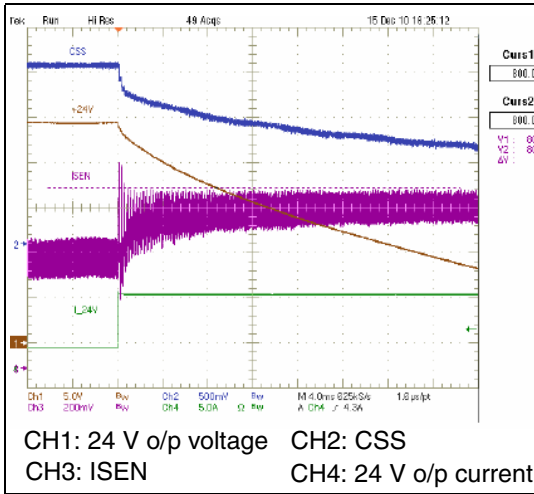

Figure 42. 24 V short-circuit at full load and 115 Vac - 60 Hz

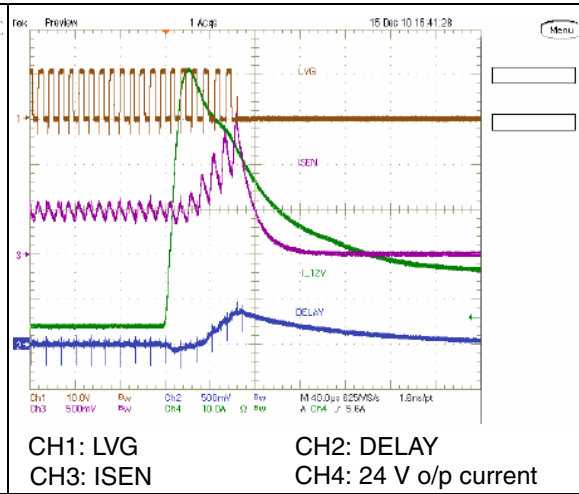

Figure 43. 12 V short-circuit at full load and 115 Vac - 60 Hz

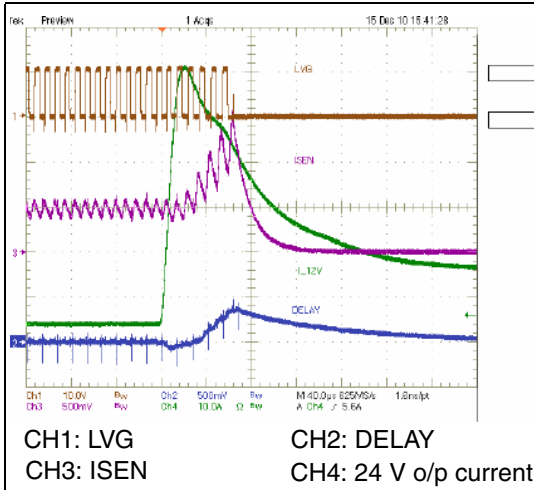

Figure 44. 130 V short-circuit at full load and 115 Vac - 60 Hz

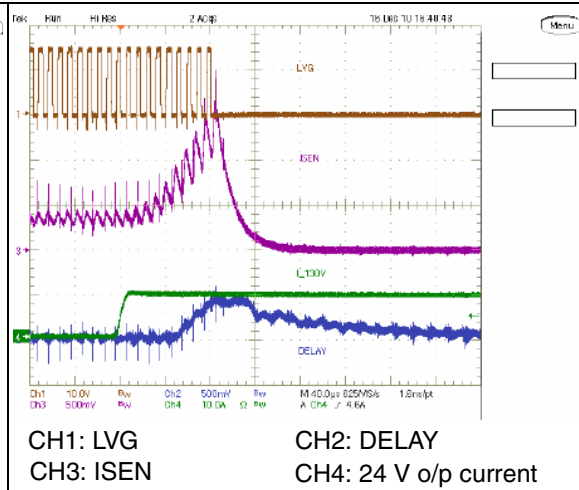

Figure 45 and 46 show the OVP intervention. In the case of overvoltage of one or more of the resonant outputs the Zener diodes D16, D17, and D29 detect the output voltages and conduct. Then Q10 conducts and turns on Q9 too. These two transistors are configured as an SCR that shorts to ground the anode of the U5 optocoupler. In this way the Q7 is no longer delivering the Vcc to the controllers and stays permanently latched until the mains voltage is recycled.

Figure 45. OVP at full load and 115 Vac on 24 V output **Figure 46. OVP at full load and 115 Vac on 12 V and 130 V outputs**

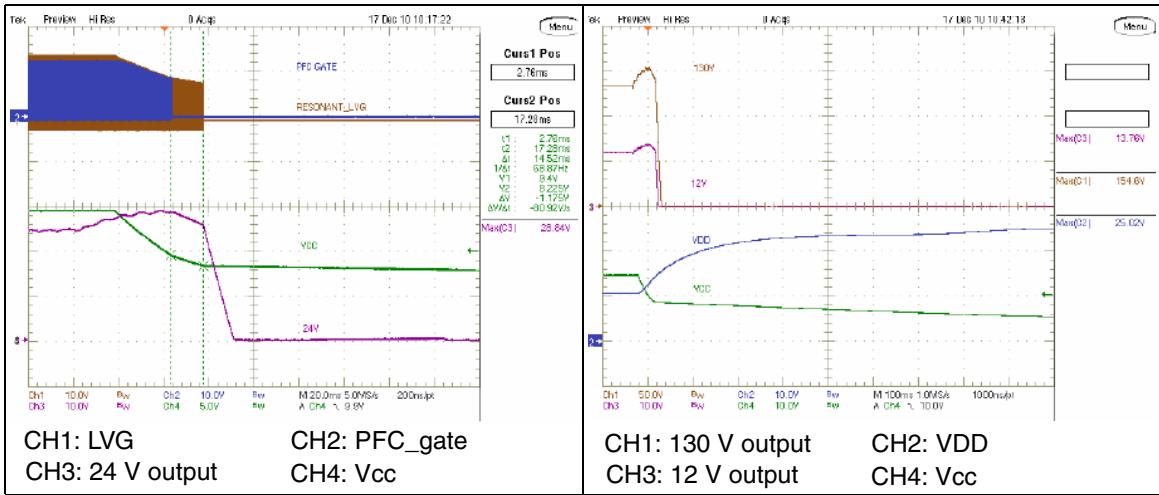
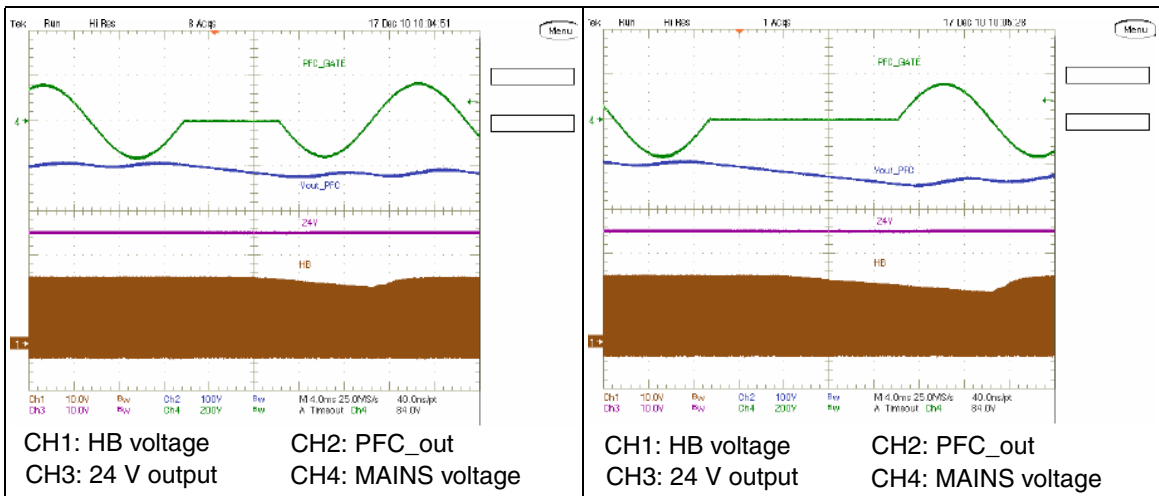

Figure 47 and 48 show resonant behavior in the case of mains dip. The L6599A senses the input voltage via the resistor divider connected to the LINE pin. As seen, it is dimensioned to keep the resonant stage on in case of PFC output voltage drop caused by mains dip.

Figure 47. Half cycle mains dip at full load and 115 Vac - 60 Hz **Figure 48. Full cycle mains dip at full load and 115 Vac - 60 Hz**



5 Thermal map

In order to check the design reliability, a thermal mapping by means of an IR camera was done. In *Figure 49* and *50* the thermal measurements of the board component side at nominal input voltage are shown. Some pointers, visible in the images, have been placed across key components. The ambient temperature during both measurements was 25 °C.

Figure 49. Thermal map at 115 Vac - 60 Hz, full load

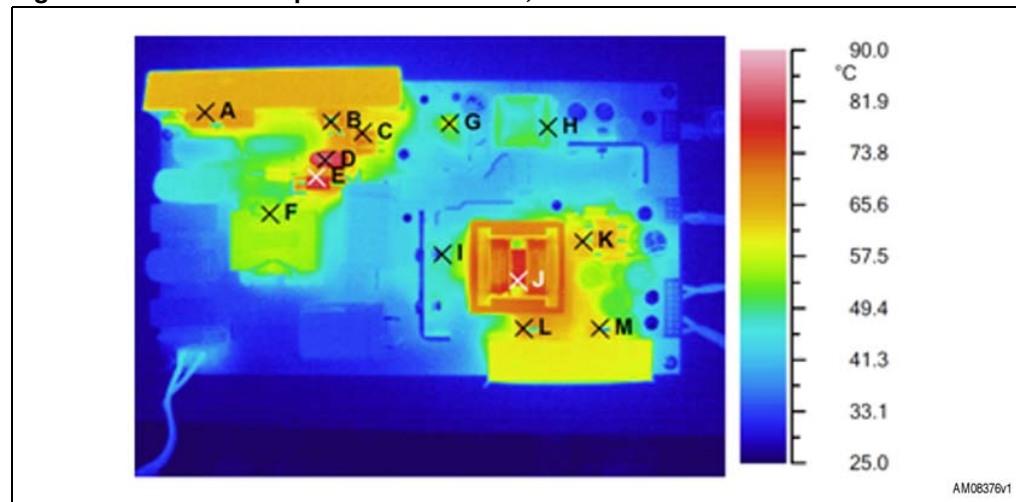

Figure 50. Thermal map at 230 Vac - 50 Hz, full load

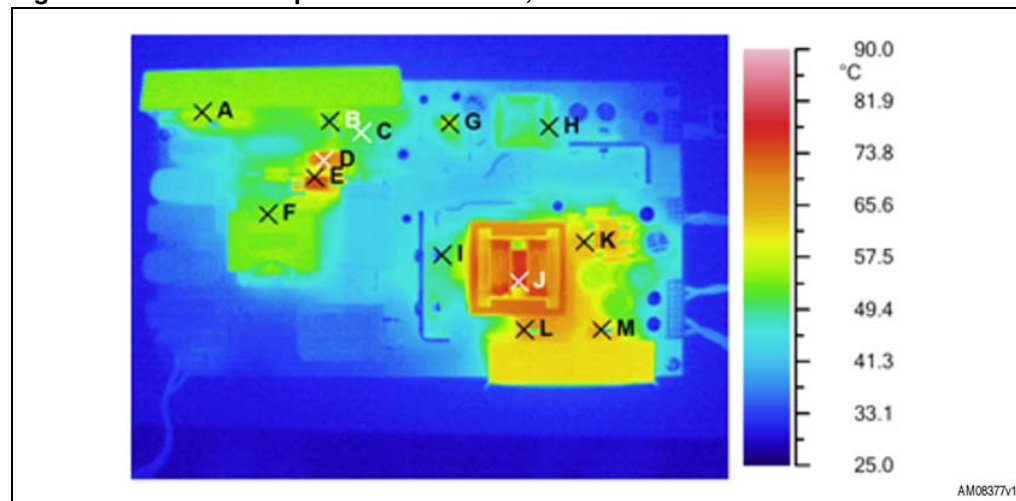

Table 2. Thermal maps reference points

Point	Reference	Description	Temperature at 115 Vac	Temperature at 230 Vac
A	D3	Bridge rectifier	69.8 °C	51.3 °C
B	Q5	PFC MOSFET	74.1 °C	59.3 °C
C	R51	Current sense resistor	72.9 °C	51.3 °C
D	R1	NTC	85.8 °C	72.6 °C
E	D2	PFC output diode	82.5 °C	74.3 °C
F	L1	PFC inductor	58.2 °C	55.4 °C
G	U5	Viper27	58.0 °C	56.8 °C
H	T2	Flyback transformer	52.1 °C	51.3 °C
I	Q6	Resonant MOSFET	54.3 °C	52.9 °C
J	T1	LLC transformer	79.6 °C	78.4 °C
K	D24	130 V o/p diode	67.6 °C	66.8 °C
L	D4	24 V o/p diode	71.2 °C	71.1 °C
M	D9	12 V o/p diode	68.8 °C	69.1 °C

6 Conducted emission pre-compliance test

Figure 51 and 52 show the peak measurement of the conducted noise at full load and nominal mains voltages. The limits shown in the diagrams are EN55022 Class-B, which is the most popular rule for domestic equipment and has more severe limits compared to Class-A, dedicated to IT technology equipment. As seen, peak measurements are below the limits relevant to average measurement (red) and more than 10 dB below quasi-peak limits (green).

Figure 51. CE peak measurement at 115 Vac and full load

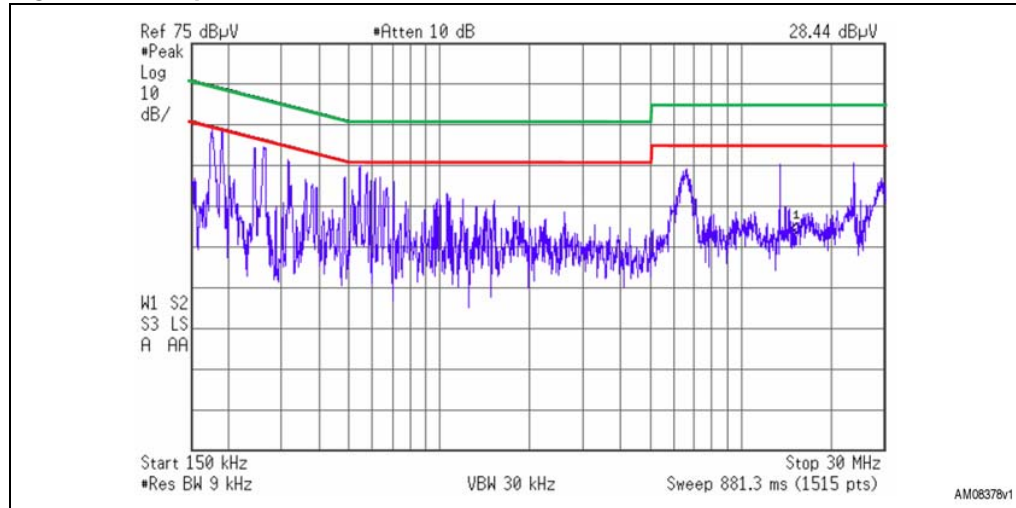
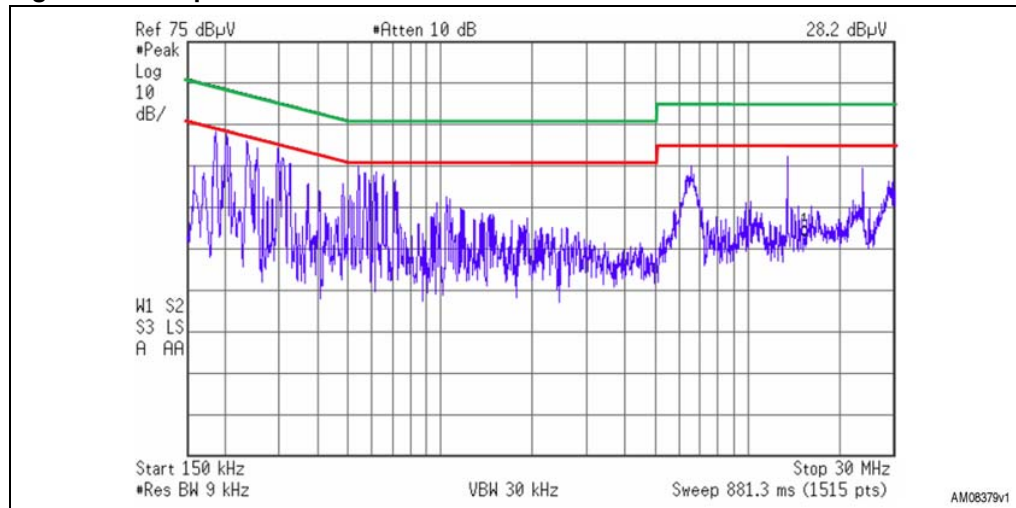

Figure 52. CE peak measurement at 230 Vac and full load



7 Bill of materials

Table 3. Bill of materials

Des.	Part type/ part value	Description	Supplier	Case style/package
C1	2.2 nF	Y1 safety cap. DE1E3KX222M	MURATA	DWG
C2	1 µF	X2 film cap-B32923C3105K	EPCOS	11x26.5 mm P 22.5 mm
C3	1 µF	X2 film cap-B32923C3105K	EPCOS	11x26.5 mm P 22.5 mm
C4	470 nF	630 V film cap-B32613A6474K	EPCOS	11x26.5 mm P 22.5 mm
C5	470 nF	630 V film cap-B32613A6474K	EPCOS	11x26.5 mm P 22.5 mm
C6	100 µF	450 V aluminium ELCAP-PZ series	Nichicon	18x35 mm P 10 mm
C7	100 µF	450 V aluminium ELCAP-PZ series	Nichicon	18x35 mm P 10 mm
C8	2.2 nF	Y1 safety cap. DE1E3KX222M	MURATA	DWG
C9	2.2 nF	Y1 safety cap. DE1E3KX222M	MURATA	DWG
C12	100 nF	50 V cericap-X7R-10 %	KEMET	1206
C13	47 nF	50 V cericap-X7R-10 %	KEMET	0805
C14	1000 µF	35 V aluminium ELCAP-YXF series	Rubycon	12x25 mm P 5 mm
C16	100 µF	50 V aluminium ELCAP-YXF series	Rubycon	8x11 mm P 3.5 mm
C17	100 nF	50 V cericap-X7R-10 %	KEMET	0805
C18	470 nF	50 V cericap-Y5V-20 %	KEMET	1206
C19	100 nF	50 V cericap-X7R-10 %	KEMET	0805
C20	470 nF	16 V cericap-X7R-10 %	KEMET	0805
C21	4.7 µF	6.3 V cericap-X5R-15 %	KEMET	0805
C23	4.7 nF	50 V cericap-X7R-10 %	KEMET	0805
C24	330 pF	50 V cericap-C0G-5 %	KEMET	0805
C25	2.2 nF	50 V cericap-X7R-10 %	KEMET	0805
C26	1000 µF	25 V aluminium ELCAP-YXF series	Rubycon	12.5x20 mm P 5 mm
C27	100 µF	50 V aluminium ELCAP-YXF series	Rubycon	8x11 mm P 3.5 mm
C28	100 nF	50 V cericap-X7R-10 %	KEMET	0805
C30	470 nF	50 V cericap-Y5V-20 %	KEMET	1206
C31	2.2 nF	50 V cericap-X7R-10 %	KEMET	0805
C32	1 µF	16 V cericap-X7R-10 %	KEMET	1206
C33	10 µF	50 V aluminium ELCAP-YXF series	Rubycon	6.3x11 mm P 2.5 mm
C34	220 pF	50 V cericap-COG-5 %	KEMET	0805
C35	4.7 nF	50 V cericap-X7R-10 %	KEMET	1206
C36	220 pF	500 V cericap-12067A221JAT2A-C0G	AVX	1206

Table 3. Bill of materials (continued)

Des.	Part type/ part value	Description	Supplier	Case style/package
C37	100 nF	50 V ceracap-X7R-10 %	KEMET	0805
C38	220 nF	16 V ceracap-X7R-10 %	KEMET	0805
C39	15 nF	1 kV-MKP film capacitor B32652A0153J	EPCOS	5x18 mm P 15 mm
C40	47 µF	50 V aluminium ELCAP-YXF series	Rubycon	6.3x11 mm P 2.5 mm
C42	10 nF	50 V ceracap-X7R-10 %	KEMET	0805
C44	47 µF	50 V aluminium ELCAP-YXF series	Rubycon	6.3x11 mm P. 2.5 mm
C45	47 nF	25 V ceracap-X7R-10 %	KEMET	0805
C46	2.2 nF	Y1 safety cap. DE1E3KX222M	MURATA	DWG
C47	10 µF	450 V aluminium ELCAP-VY series	Nichicon	10x20 mm P 5 mm
C49	1000 µF	10 V aluminium ELCAP-ZLH series	Rubycon	8X16 mm P 3.5 mm
C50	1000 µF	10 V aluminium ELCAP-ZLH series	Rubycon	8X16 mm P 3.5 mm
C51	220 µF	16 V aluminium ELCAP-ZLH series	Rubycon	6.3X11 mm P 2.5 mm
C52	100 nF	50 V ceracap-X7R-10 %	KEMET	0805
C53	22 µF	50 V aluminium ELCAP-YXF series	Rubycon	5x11 mm P 2 mm
C54	100 nF	50 V ceracap-X7R-10 %	KEMET	0805
C55	2.2 nF	50 V ceracap-X7R-10 %	KEMET	0805
C56	100 nF	50 V ceracap-X7R-10 %	KEMET	0805
C59	10 nF	50 V ceracap-X7R-10 %	KEMET	0805
C60	100 nF	50 V ceracap-X7R-10 %	KEMET	0805
C61	10 nF	50 V ceracap-X7R-10 %	KEMET	0805
C62	10 µF	50 V aluminium ELCAP-YXF series	Rubycon	6.3x11 mm P 2.5 mm
C63	10 nF	50 V ceracap-X7R-10 %	KEMET	0805
C64	1 nF	100 V ceracap-X7R-10 %	KEMET	1206
C65	220 pF	50 V ceracap-COG-5 %	KEMET	0805
C66	47 µF	200 V aluminium ELCAP-ED series	Panasonic	12.5x20 mm P 5 mm
C67	4.7 µF	200 V aluminium ELCAP-KMG series	UNITED CHEMI-CON	8x11 mm P 3.5 mm
C68	100 nF	200 V ceracap-X7R-20 %	KEMET	1206
C69	1000 µF	25 V aluminium ELCAP-YXF series	Rubycon	12.5x20 mm P 5 mm
D1	1N5406	Rectifier	VISHAY	DO-201
D2	STTH5L06	Ultrafast high voltage rectifier	STMicroelectronics	DO-201
D3	D10XB60H	Single phase bridge rectifier	SHINDENGEN	DWG
D4	STPS20H100CFP	HV power Schottky rectifier	STMicroelectronics	TO-220FP
D5	LL4148WS	High speed signal diode	VISHAY	SOD323

Table 3. Bill of materials (continued)

Des.	Part type/ part value	Description	Supplier	Case style/package
D6	LL4148WS	High speed signal diode	VISHAY	SOD323
D7	LL4148WS	High speed signal diode	VISHAY	SOD323
D8	LL4148WS	High speed signal diode	VISHAY	SOD323
D9	STPS20L45CFP	Power Schottky rectifier	STMicroelectronics	TO-220FP
D10	LL4148WS	High speed signal diode	VISHAY	SOD323
D12	LL4148WS	High speed signal diode	VISHAY	SOD323
D13	MMSZ4709-V	24 V Zener diode	VISHAY	SOD323
D14	LL4148WS	High speed signal diode	VISHAY	SOD323
D15	BZV55-C15	Zener diode	VISHAY	MINIMELF
D16	MMSZ4711-V	27 V Zener diode	VISHAY	SOD323
D17	MMSZ4700-V	13 V Zener diode	VISHAY	SOD123
D18	STPS20L45CFP	Power Schottky rectifier	STMicroelectronics	TO-220FP
D19	P6KE250A	Transil	STMicroelectronics	DO-15
D20	STTH108A	HV ultrafast rectifier	STMicroelectronics	SMA
D21	BAV103	High speed signal diode	VISHAY	MINIMELF
D22	STTH102A	High efficiency ultrafast diode	STMicroelectronics	SMA
D24	STTH3R02	Ultrafast diode	STMicroelectronics	DO-201
D25	STTH3R02	Ultrafast diode	STMicroelectronics	DO-201
D26	STTH3R02	Ultrafast diode	STMicroelectronics	DO-201
D27	STTH3R02	Ultrafast diode	STMicroelectronics	DO-201
D28	LL4148WS	High speed signal diode	VISHAY	SOD323
D29	BZV55-C75	75 V Zener diode	VISHAY	MINIMELF
D30	BZV55-C75	75 V Zener diode	VISHAY	MINIMELF
F1	Fuse T4A	Fuse 4 A-time lag-3691400	Littelfuse	8.5x4 mm P 5.08 mm
HS1	Heatsink	Heatsink for D3 and Q5		DWG
HS2	Heatsink	Heatsink for Q3 and Q6		DWG
HS3	Heatsink	Heatsink for D4 and D9		DWG
HS4	Heatsink	Heatsink for D18		DWG
J1	Connector	3 pins (central removed)-09-65-2038	Molex	DWG
J2	Connector	P. 2.54 mm-8 x 2 rows-280385-2	AMP	DWG
J3	Connector	P. 2.54 mm-4 x 2 rows-280384-2	AMP	DWG
J4	Connector	P. 2.54 mm-3 x 2 rows-5-102618-1	AMP	DWG
L1	240 μ H	2086.0001-PFC inductor	MAGNETICA	DWG
L2	3 mH	1606.0007-EMI filter	MAGNETICA	DWG

Table 3. Bill of materials (continued)

Des.	Part type/ part value	Description	Supplier	Case style/package
L3	70 μ H	1119.0013-DM inductor	MAGNETICA	26x13 mm
L4	1 μ H	10710083-5 A inductor	MAGNETICA	9x12 mm P 5 mm
L5	1 μ H	10710083-5 A inductor	MAGNETICA	9x12 mm P 5 mm
L6	1 μ H	10710083-5 A inductor	MAGNETICA	9x12 mm P 5 mm
L7	1 μ H	10710083-5 A inductor	MAGNETICA	9x12 mm P 5 mm
Q3	STF12NM50N	N-channel power MOSFET	STMicroelectronics	TO-220FP
Q5	STF14NM50N	N-channel power MOSFET	STMicroelectronics	TO-220FP
Q6	STF12NM50N	N-channel power MOSFET	STMicroelectronics	TO-220FP
Q7	BC847C	NPN small signal BJT	VISHAY	SOT-23
Q8	BC847C	NPN small signal BJT	VISHAY	SOT-23
Q9	BC857C	PNP small signal BJT	VISHAY	SOT-23
Q10	BC847C	NPN small signal BJT	VISHAY	SOT-23
Q11	BC847C	NPN small signal BJT	VISHAY	SOT-23
R1	NTC 2R5	NTC resistor - B57237S0259M000	EPCOS	DWG
R2	2.2 M Ω	SMD film res-1/4 W-1 %-100 ppm/ $^{\circ}$ C	VISHAY	1206
R3	27 k Ω	SMD film res-1/8 W-1 %-100 ppm/ $^{\circ}$ C	VISHAY	0805
R4	2.2 M Ω	SMD film res-1/4 W-1 %-100 ppm/ $^{\circ}$ C	VISHAY	1206
R5	2.2 M Ω	SMD film res-1/4 W-1 %-100 ppm/ $^{\circ}$ C	VISHAY	1206
R6	4.7 M Ω	SMD film res-1/4 W-1 %-100 ppm/ $^{\circ}$ C	VISHAY	1206
R7	2.2 M Ω	SMD film res-1/4 W-1 %-100 ppm/ $^{\circ}$ C	VISHAY	1206
R8	2.2 M Ω	SMD film res-1/4 W-1 %-100 ppm/ $^{\circ}$ C	VISHAY	1206
R9	220 k Ω	SMD film res-1/8 W-1 %-100 ppm/ $^{\circ}$ C	VISHAY	0805
R10	51 k Ω	SMD film res-1/8 W-1 %-100 ppm/ $^{\circ}$ C	VISHAY	0805
R11	3.9 M Ω	SMD film res-1/4 W-1 %-100 ppm/ $^{\circ}$ C	VISHAY	1206
R13	130 k Ω	SMD film res-1/8 W-5 %-250 ppm/ $^{\circ}$ C	VISHAY	0805
R15	2.2 M Ω	SMD film res-1/4 W-1 %-100 ppm/ $^{\circ}$ C	VISHAY	1206
R16	3.9 M Ω	SMD film res-1/4 W-1 %-100 ppm/ $^{\circ}$ C	VISHAY	1206
R17	200 k Ω	SMD film res-1/4 W-1 %-100 ppm/ $^{\circ}$ C	VISHAY	1206
R18	56 Ω	SMD film res-1/8 W-5 %-250 ppm/ $^{\circ}$ C	VISHAY	0805
R20	100 k Ω	SMD film res-1/8 W-5 %-250 ppm/ $^{\circ}$ C	VISHAY	0805
R21	10 Ω	SMD film res-1/8 W-5 %-250 ppm/ $^{\circ}$ C	VISHAY	0805
R22	3.9 k Ω	SMD film res-1/4 W-5 %-250 ppm/ $^{\circ}$ C	VISHAY	1206
R23	4.7 M Ω	SMD film res-1/8 W-5 %-250 ppm/ $^{\circ}$ C	VISHAY	0805
R24	4.7 k Ω	SMD film res-1/4 W-5 %-250 ppm/ $^{\circ}$ C	VISHAY	1206

Table 3. Bill of materials (continued)

Des.	Part type/ part value	Description	Supplier	Case style/package
R25	10 Ω	SMD film res-1/8 W-5 %-250 ppm/ $^{\circ}$ C	VISHAY	0805
R27	2.2 Ω	SMD film res-1/8 W-5 %-250 ppm/ $^{\circ}$ C	VISHAY	0805
R29	4.7 k Ω	SMD film res-1/4 W-5 %-250 ppm/ $^{\circ}$ C	VISHAY	1206
R31	100 k Ω	SMD film res-1/8 W-5 %-250 ppm/ $^{\circ}$ C	VISHAY	0805
R32	22 Ω	SMD film res-1/8 W-5 %-250 ppm/ $^{\circ}$ C	VISHAY	0805
R33	200 k Ω	SMD film res-1/8 W-1 %-100 ppm/ $^{\circ}$ C	VISHAY	0805
R34	10 Ω	SMD film res-1/8 W-5 %-250 ppm/ $^{\circ}$ C	VISHAY	0805
R36	12 k Ω	SMD film res-1/8 W-1 %-100 ppm/ $^{\circ}$ C	VISHAY	0805
R37	3.9 k Ω	SMD film res-1/4 W-5 %-250 ppm/ $^{\circ}$ C	VISHAY	1206
R38	0	SMD film res-1/8 W-1 %-100 ppm/ $^{\circ}$ C	VISHAY	0805
R40	1 k Ω	SMD film res-1/8 W-5 %-250 ppm/ $^{\circ}$ C	VISHAY	0805
R41	56 Ω	SMD film res-1/8 W-5 %-250 ppm/ $^{\circ}$ C	VISHAY	0805
R43	1 M Ω	SMD film res-1/8 W-1 %-100 ppm/ $^{\circ}$ C	VISHAY	0805
R44	100 k Ω	SMD film res-1/8 W-5 %-250 ppm/ $^{\circ}$ C	VISHAY	0805
R45	10 k Ω	SMD film res-1/8 W-1 %-100 ppm/ $^{\circ}$ C	VISHAY	0805
R46	220 Ω	SMD film res-1/4 W-5 %-250 ppm/ $^{\circ}$ C	VISHAY	1206
R47	0	SMD film res-1/4 W-1 %-100 ppm/ $^{\circ}$ C	VISHAY	1206
R49	33 k Ω	SMD film res-1/8 W-1 %-100 ppm/ $^{\circ}$ C	VISHAY	0805
R50	180 k Ω	SMD film res-1/8 W-1 %-100 ppm/ $^{\circ}$ C	VISHAY	0805
R51	0.47 Ω	RSMF1TB-metal film res-1 W-2 %	AKANE OHM	PTH
R52	0.47 Ω	RSMF1TB-metal film res-1 W-2 %	AKANE OHM	PTH
R53	100 Ω	SMD film res-1/4 W-1 %-100 ppm/ $^{\circ}$ C	VISHAY	1206
R54	470 k Ω	SMD film res-1/8 W- 5 %-250 ppm/ $^{\circ}$ C	VISHAY	0805
R55	68 Ω	SMD film res-1/8 W-5 %-250 ppm/ $^{\circ}$ C	VISHAY	0805
R56	5.6 k Ω	SMD film res-1/8 W-5 %-250 ppm/ $^{\circ}$ C	VISHAY	0805
R57	51 Ω	SMD film res-1/8 W-5 %-250 ppm/ $^{\circ}$ C	VISHAY	0805
R59	1 k Ω	SMD film res-1/8 W-5 %-250 ppm/ $^{\circ}$ C	VISHAY	0805
R60	47 k Ω	SMD film res-1/8 W-5 %-250 ppm/ $^{\circ}$ C	VISHAY	0805
R61	680 k Ω	SMD film res-1/8 W-1-100 ppm/ $^{\circ}$ C	VISHAY	0805
R62	43 k Ω	SMD film res-1/8 W-1 %-100 ppm/ $^{\circ}$ C	VISHAY	0805
R64	1 k Ω	SMD film res-1/8 W-5 %-250 ppm/ $^{\circ}$ C	VISHAY	0805
R65	180 k Ω	SMD film res -1/8 W-5 %-250 ppm/ $^{\circ}$ C	VISHAY	0805
R66	22 k Ω	SMD film res-1/8 W-1 %-100 ppm/ $^{\circ}$ C	VISHAY	0805
R67	15 k Ω	SMD film res 1/8 W-1 %-100 ppm/ $^{\circ}$ C	VISHAY	0805

Table 3. Bill of materials (continued)

Des.	Part type/ part value	Description	Supplier	Case style/package
R68	1 k Ω	SMD film res-1/8 W-5 %-250 ppm/ $^{\circ}$ C	VISHAY	0805
R69	4.7 k Ω	SMD film res-1/8 W-5 %-250 ppm/ $^{\circ}$ C	VISHAY	0805
R70	10 k Ω	SMD film res-1/8 W-5 %-250 ppm/ $^{\circ}$ C	VISHAY	0805
R71	4.7 k Ω	SMD film res-1/8 W-5 %-250 ppm/ $^{\circ}$ C	VISHAY	0805
R72	1 k Ω	SMD film res-1/8 W-5 %-250 ppm/ $^{\circ}$ C	VISHAY	0805
R73	1 k Ω	SMD film res-1/8 W-5 %-250 ppm/ $^{\circ}$ C	VISHAY	0805
R74	2.7 k Ω	SMD film res-1/8 W-5 %-250 ppm/ $^{\circ}$ C	VISHAY	0805
R75	1 Ω	NFR25H-axial fusible res-1/2 W-5 %	VISHAY	PTH
R76	150 k Ω	SMD film res-1/4 W-1 %-100 ppm/ $^{\circ}$ C	VISHAY	1206
R78	3.9 Ω	SMD film res-1/4 W-5 %-250 ppm/ $^{\circ}$ C	VISHAY	1206
R79	390 k Ω	AXIAL film res-1/8 W-5 %-100 ppm/ $^{\circ}$ C	VISHAY	AXIAL 1.6x3.6 mm
R80	82 k Ω	SMD film res-1/8 W-1 %-100 ppm/ $^{\circ}$ C	VISHAY	0805
R81	27 k Ω	SMD film res-1/8 W-5 %-250 ppm/ $^{\circ}$ C	VISHAY	0805
R82	1 k Ω	SMD film res-1/8 W-5 %-250 ppm/ $^{\circ}$ C	VISHAY	0805
R83	27 k Ω	SMD film res-1/8 W-5 %-250 ppm/ $^{\circ}$ C	VISHAY	0805
R84	12 k Ω	SMD film res-1/8 W-5 %-250 ppm/ $^{\circ}$ C	VISHAY	0805
R86	120 k Ω	SMD film res-1/8 W-1 %-100 ppm/ $^{\circ}$ C	VISHAY	0805
R87	270 k Ω	SMD film res-1/8 W-5 %-250 ppm/ $^{\circ}$ C	VISHAY	0805
R88	39 k Ω	SMD film res-1/8 W-1 %-100 ppm/ $^{\circ}$ C	VISHAY	0805
R89	47 k Ω	SMD film res-1/8 W-1 %-100 ppm/ $^{\circ}$ C	VISHAY	0805
R90	10 Ω	SMD film res-1/4 W-5 %-250 ppm/ $^{\circ}$ C	VISHAY	1206
R91	220 k Ω	SMD film res-1/4 W-5 %-250 ppm/ $^{\circ}$ C	VISHAY	1206
R92	2.7 k Ω	SMD film res-1/8 W-5 %-250 ppm/ $^{\circ}$ C	VISHAY	0805
R93	2.2 Ω	AXIAL film res-1/8 W-5 %-100 ppm/ $^{\circ}$ C	VISHAY	AXIAL 1.6x3.6 mm
R94	22 k Ω	AXIAL film res-1/8 W-5 %-100 ppm/ $^{\circ}$ C	VISHAY	AXIAL 1.6x3.6 mm
R95	1 k Ω	SMD film res-1/8 W-5 %-250 ppm/ $^{\circ}$ C	VISHAY	0805
R96	0.47 Ω	RSMF1TB metal film res-1 W-2 %	AKANE OHM	PTH
R97	4.7 M Ω	SMD film res-1/8 W-1 %-100 ppm/ $^{\circ}$ C	VISHAY	0805
R98	1 k Ω	SMD film res-1/8 W-5 %-250 ppm/ $^{\circ}$ C	VISHAY	0805
R99	150 k Ω	SMD film res-1/4 W-1 %-100 ppm/ $^{\circ}$ C	VISHAY	1206
R100	150 k Ω	SMD film res-1/4 W-1 %-100 ppm/ $^{\circ}$ C	VISHAY	1206
RV1	300Vac	MOV-B72214S0301K101	EPCOS	15x5 mm P 7.5 mm

Table 3. Bill of materials (continued)

Des.	Part type/ part value	Description	Supplier	Case style/package
RX2	0	SMD film res-1/4 W-5 %-250 ppm/°C	VISHAY	1206
T1	1860.0052	Resonant transformer	MAGNETICA	DWG
T2	1715.0059	Standby flyback transformer	MAGNETICA	DWG
U1	L6564D	10-pin transition-mode PFC controller	STMicroelectronics	SSOP10
U2	L6599A	Improved HV resonant controller	STMicroelectronics	SO-16
U3	SFH610A-2	Optocoupler	Infineon	DIP-4 - 10.16 mm
U4	TL431ACZ	Programmable shunt voltage ref.	STMicroelectronics	TO-92
U5	SFH610A-2	Optocoupler	Infineon	DIP-4 - 10.16 mm
U6	VIPER27LN	Offline HV converter	STMicroelectronics	DIP8
U7	SFH610A-2	Optocoupler	Infineon	DIP-4 - 10.16 mm
U8	TS431AZ	Programmable shunt voltage ref.	STMicroelectronics	TO-92

8 PFC coil specification

General description and characteristics

- Application type: consumer, home appliance
- Transformer type: open
- Coil former: vertical type, 6+6 pins
- Max. temp. rise: 45 °C
- Max. operating ambient temperature: 60 °C
- Mains insulation: n.a
- Unit finishing: varnished

Electrical characteristics

- Converter topology: boost, transition mode
- Core type: PQ32/20-PC44 or equivalent
- Min. operating frequency: 30 kHz
- Typical operating frequency: 120 kHz
- Primary inductance: 240 $\mu\text{H} \pm 15\%$ at 1 kHz-0.25 V ^(a)

Electrical diagram and winding characteristics

Figure 53. PFC coil electrical diagram

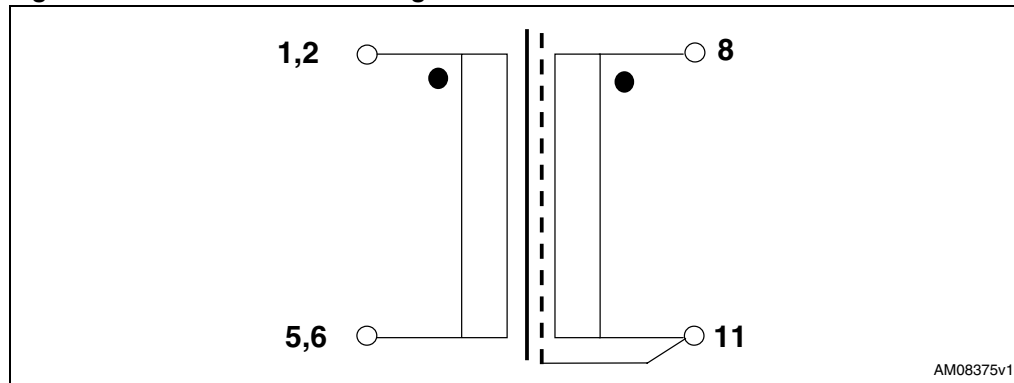

Table 4. PFC coil winding data

Pins	Windings	RMS current	Number of turns	Wire type
8 - 11	AUX	0.05 Arms	3 spaced	ϕ 0.3 mm - G2
1,2 - 5,6	Primary	2.65 Arms	28	2x40 ϕ 0.1 mm - G2

a. Measured between pins 1,2 and 5,6.

Mechanical aspect and pin numbering

- Maximum height from PCB: 22 mm
- Coil former type: vertical, 6+6 pins (pins #3, 4, 7, and 12 are removed)
- Pin distance: 5.08 mm
- Row distance: 30.5 mm
- External copper shield: not insulated, wound around the ferrite core and including the coil former. Height is 8 mm. Connected to pin #11 by a soldered solid wire.

Figure 54. PFC coil mechanical aspect

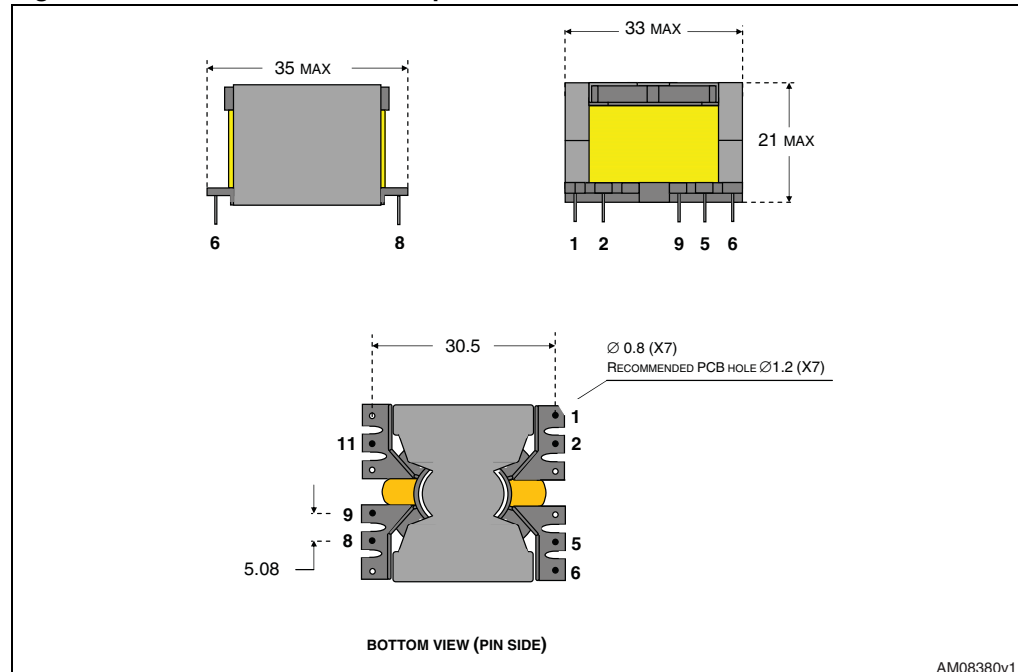

Manufacturer

- MAGNETICA - Italy
- Inductor P/N: 2086.0001

9 Resonant power transformer specification

General description and characteristics

- Application type: consumer, home appliance
- Transformer type: open
- Coil former: horizontal type, 7+7 pins, two slots
- Max. temp. rise: 45 °C
- Max. operating ambient temperature: 60 °C
- Mains insulation: acc. to EN60065

Electrical characteristics

- Converter topology: half bridge, resonant
- Core type: ETD34-PC44 or equivalent
- Min. operating frequency: 60 kHz
- Typical operating frequency: 110 kHz
- Primary inductance: 620 $\mu\text{H} \pm 10\%$ at 1 kHz-0.25 V^(b)
- Leakage inductance: 105 μH at 100 kHz-0.25 V^(c)

Electrical diagram and winding characteristics

Figure 55. Transformer electrical diagram

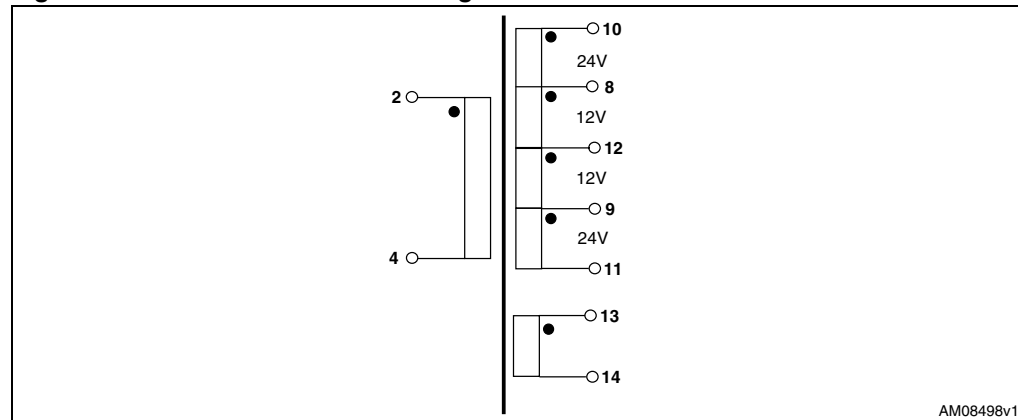

Table 5. Transformer winding data

Pins	Winding	RMS current	Number of turns	Wire type
2 - 4	Primary	1.2 Arms	36	40x ϕ 0.1 mm - G2
8 - 12	SEC 12-A ⁽¹⁾	4 Arms	2	90x ϕ 0.1 mm - G2

b. Measured between pins 2-4.

c. Measured between pins 2-4 shorting pins 12, 9, 11, 13, 14.

Table 5. Transformer winding data (continued)

Pins	Winding	RMS current	Number of turns	Wire type
12 - 9	SEC 12 - B ⁽¹⁾	4 Arms	2	90x ϕ 0.1 mm - G2
10 - 8	SEC 24 - A ⁽¹⁾	1.6 Arms	2	90x ϕ 0.1 mm - G2
9 - 11	SEC 24 - B ⁽¹⁾	1.6 Arms	2	90x ϕ 0.1 mm - G2
13 - 14	SEC 130	0.7 Arms	21	90x ϕ 0.1 mm - G2

1. Secondary windings A and B are in parallel.

Mechanical aspect and pin numbering

- Maximum height from PCB: 30 mm
- Coil former type: horizontal, 7+7 pins (pins #3 and 5 are removed)
- Pin distance: 5.08 mm
- Row distance: 25.4 mm

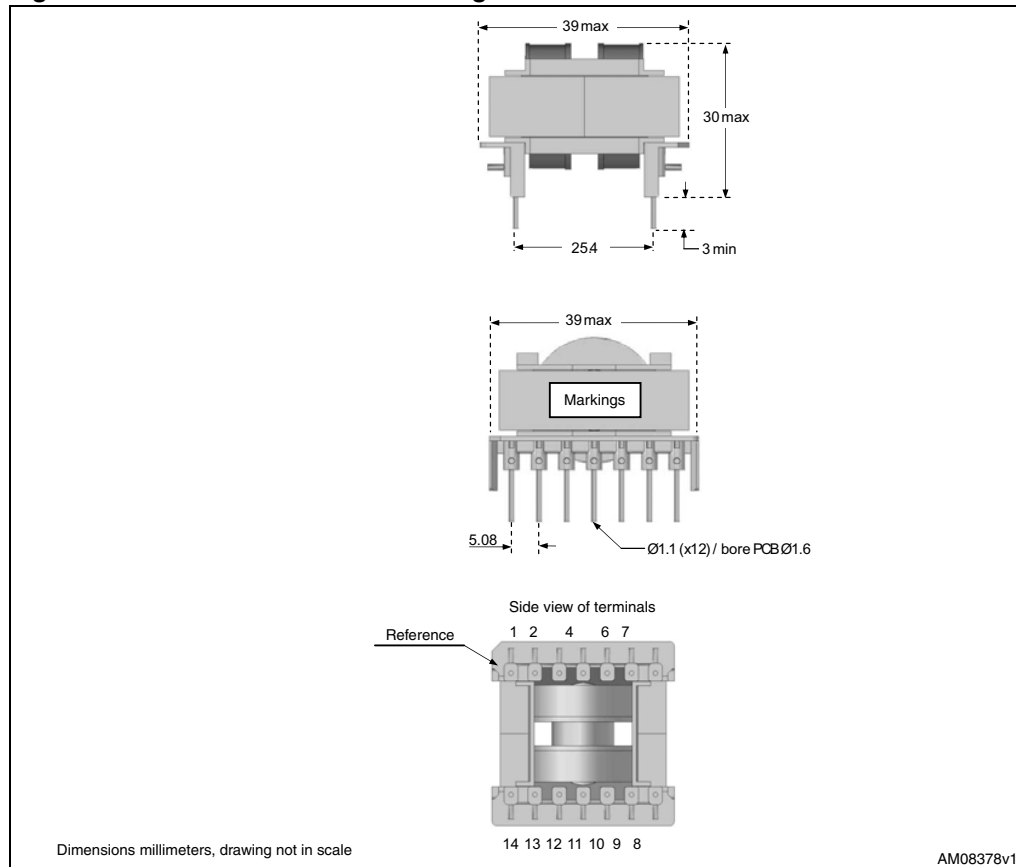
Figure 56. Transformer overall drawing

Manufacturer

- MAGNETICA - Italy
- Transformer P/N: 1860.0052

10 Flyback transformer specification

General description and characteristics

- Application type: consumer, home appliance
- Transformer type: open
- Coil former: horizontal type, 5+4 pins
- Max. temp. rise: 45 °C
- Max. operating ambient temperature: 60 °C
- Mains insulation: acc. to EN60065

Electrical characteristics

- Converter topology: fixed frequency flyback
- Core type: E20-PC44 or equivalent
- Typical operating frequency: 60 kHz
- Primary inductance: 2.38 mH \pm 15 % at 1 kHz-0.25 V^(d)
- Leakage inductance: <30 μ H at 100 kHz-0.25 V^(e)

Electrical diagram and winding characteristics

Figure 57. Flyback transformer electrical diagram

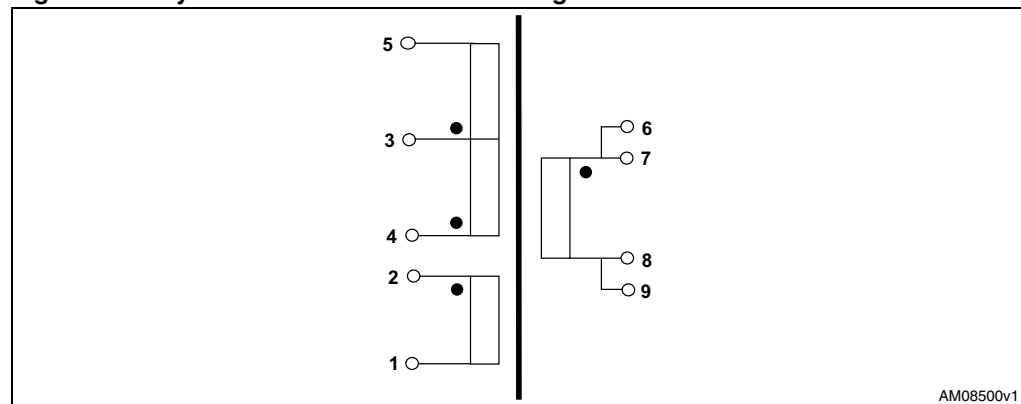

Table 6. Transformer winding data

Pins	Winding	RMS current	Number of turns	Wire type
4 - 5	Primary	0.17 Arms ⁽¹⁾	93	ϕ 0.224 mm - G2
2 - 1	Aux	0.05 Arms	18 spaced	ϕ 0.224 mm - G2
6 - 8	Secondary A	1.3 Arms	6	ϕ 0.7 mm - TIW
7 - 9	Secondary B	1.3 Arms	6	ϕ 0.7 mm - TIW

1. Secondary A and B wound in parallel.

d. Measured between pins 2-4.

e. Measured between pins 2-4 shorting pins 12, 9, 11, 13, 14.

Mechanical aspect and pin numbering

- Maximum height from PCB: 18 mm
- Coil former type: horizontal, 5+4 pins (pin #3 missing)
- Primary pin distance: 3.81 mm
- Secondary pin distance: 5.08 mm
- Row distance: 19.05 mm

Figure 58. Flyback transformer overall drawing

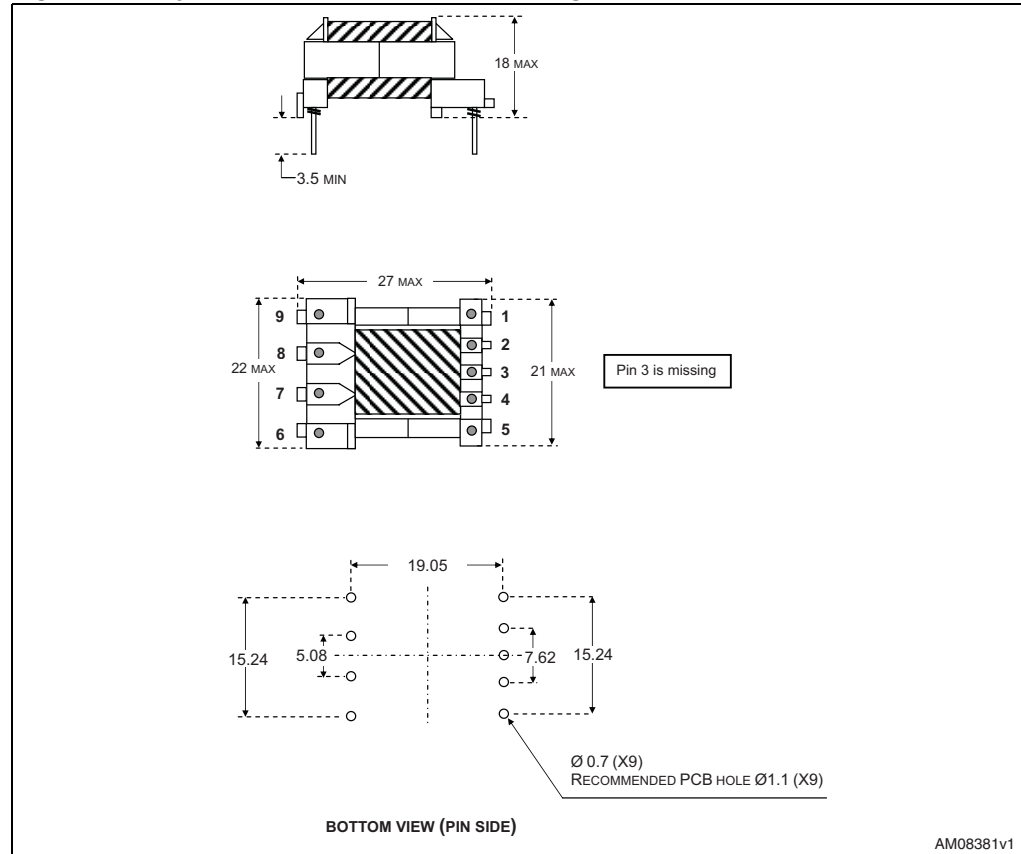

Manufacturer

- MAGNETICA - Italy
- Transformer P/N: 1715.0059

11 Revision history

Table 7. Document revision history

Date	Revision	Changes
23-Feb-2011	1	Initial release.

Please Read Carefully:

Information in this document is provided solely in connection with ST products. STMicroelectronics NV and its subsidiaries ("ST") reserve the right to make changes, corrections, modifications or improvements, to this document, and the products and services described herein at any time, without notice.

All ST products are sold pursuant to ST's terms and conditions of sale.

Purchasers are solely responsible for the choice, selection and use of the ST products and services described herein, and ST assumes no liability whatsoever relating to the choice, selection or use of the ST products and services described herein.

No license, express or implied, by estoppel or otherwise, to any intellectual property rights is granted under this document. If any part of this document refers to any third party products or services it shall not be deemed a license grant by ST for the use of such third party products or services, or any intellectual property contained therein or considered as a warranty covering the use in any manner whatsoever of such third party products or services or any intellectual property contained therein.

UNLESS OTHERWISE SET FORTH IN ST'S TERMS AND CONDITIONS OF SALE ST DISCLAIMS ANY EXPRESS OR IMPLIED WARRANTY WITH RESPECT TO THE USE AND/OR SALE OF ST PRODUCTS INCLUDING WITHOUT LIMITATION IMPLIED WARRANTIES OF MERCHANTABILITY, FITNESS FOR A PARTICULAR PURPOSE (AND THEIR EQUIVALENTS UNDER THE LAWS OF ANY JURISDICTION), OR INFRINGEMENT OF ANY PATENT, COPYRIGHT OR OTHER INTELLECTUAL PROPERTY RIGHT.

UNLESS EXPRESSLY APPROVED IN WRITING BY AN AUTHORIZED ST REPRESENTATIVE, ST PRODUCTS ARE NOT RECOMMENDED, AUTHORIZED OR WARRANTED FOR USE IN MILITARY, AIR CRAFT, SPACE, LIFE SAVING, OR LIFE SUSTAINING APPLICATIONS, NOR IN PRODUCTS OR SYSTEMS WHERE FAILURE OR MALFUNCTION MAY RESULT IN PERSONAL INJURY, DEATH, OR SEVERE PROPERTY OR ENVIRONMENTAL DAMAGE. ST PRODUCTS WHICH ARE NOT SPECIFIED AS "AUTOMOTIVE GRADE" MAY ONLY BE USED IN AUTOMOTIVE APPLICATIONS AT USER'S OWN RISK.

Resale of ST products with provisions different from the statements and/or technical features set forth in this document shall immediately void any warranty granted by ST for the ST product or service described herein and shall not create or extend in any manner whatsoever, any liability of ST.

ST and the ST logo are trademarks or registered trademarks of ST in various countries.

Information in this document supersedes and replaces all information previously supplied.

The ST logo is a registered trademark of STMicroelectronics. All other names are the property of their respective owners.

© 2011 STMicroelectronics - All rights reserved

STMicroelectronics group of companies

Australia - Belgium - Brazil - Canada - China - Czech Republic - Finland - France - Germany - Hong Kong - India - Israel - Italy - Japan - Malaysia - Malta - Morocco - Philippines - Singapore - Spain - Sweden - Switzerland - United Kingdom - United States of America

www.st.com

