

SMD ▪ Low Power LED 67-21/XK2C-SXXXXXXXXXX/2T



Features

- P-LCC-2 package
- Top view LED
- Wide viewing angle:120°
- High Luminous intensity
- High Efficacy
- Pb-free
- RoHS-compliant
- ANSI Binning

Description

The Everlight 67-21 package has high efficacy, high CRI, low power consumption, wide viewing angle and a compact form factor. These features make this package an ideal LED for all lighting applications.

Applications

- General lighting
- Decorative and Entertainment Lighting
- Indicators
- Illumination
- Switch lights

Product Number Explanation

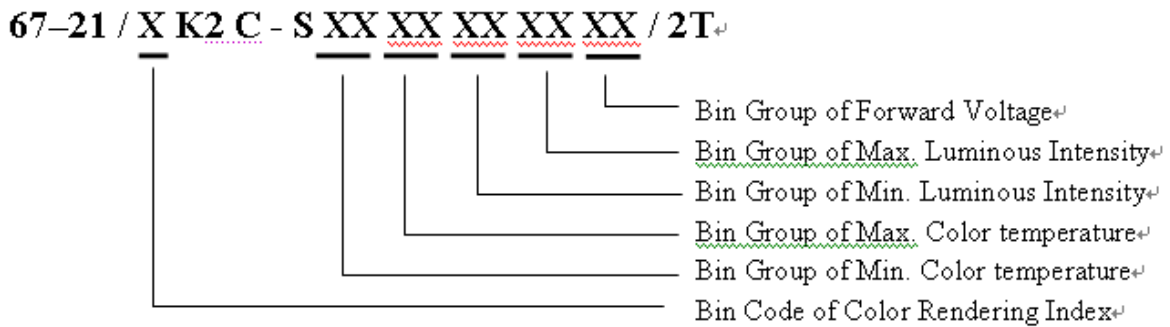

Notes

Table of Color Rendering Index

Symbol	Description
M	CRI(min) : 60
N	CRI(min) : 65
L	CRI(min) : 70
Q	CRI(min) : 75
K	CRI(min) : 80
H	CRI(min) : 90

Notes:

1. Tolerance of Color Rendering Index: ±2

Example:

67-21/KK2C-S3030AC2CB2/2T

CRI	Min=80
CCT	3000K
IV	1800mcd~2200mcd
VF	2.9V~3.6V

Mass Production list

Product	CRI min.	CCT(K)	IV(mcd) Min	IV(mcd) Max	Φ (lm) Typ.
67-21/KK2C-S3030AC2CB2/2T	80	3000K	1800	2200	6.20
67-21/KK2C-S4040AC2CB2/2T	80	4000K	1800	2200	6.20

Device Selection Guide

Chip Materials	Emitted Color	Resin Color
InGaN	Neutral White Warm White	Water Clear

Absolute Maximum Ratings (Ta=25°C)

Parameter	Symbol	Rating	Unit
Reverse Voltage	V_R	5	V
Forward Current	I_F	30	mA
Peak Forward Current (Duty 1/10 @1KHz)	I_{FP}	100	mA
Power Dissipation	P_d	110	mW
Electrostatic Discharge	ESD	1000	°C
Thermal Resistance	R_{thj-L}	200	K/W
Operating Temperature	T_{opr}	-40 ~ +110	°C
Storage Temperature	T_{stg}	-40 ~ +110	°C
Soldering Temperature	T_{sol}	Reflow Soldering : 260 °C for 10 sec. Hand Soldering : 350 °C for 3 sec.	

Electro-Optical Characteristics (Ta=25°C)

Parameter	Symbol	Min.	Typ.	Max.	Unit	Condition
Viewing Angle	2θ _{1/2}	----	120	----	deg	I _F =20mA
Reverse Current	I _R	----	----	50	μA	V _R =5V

Bin Range of Luminous Intensity

Bin Code	Min.	Max.	Unit	Condition
AC	1800	2000	mcd	I _F =20mA
2C	2000	2200		
4C	2200	2400		
6C	2400	2600		
8C	2600	2800		

Note:
 Tolerance of Luminous Intensity: ±11%

Bin Range of Forward Voltage

Group	Bin Code	Min.	Max.	Unit	Condition	
G		34	2.7	2.8	v	I _F =20mA
		35	2.8	2.9		
	B2	36	2.9	3.0		
		37	3.0	3.1		
		38	3.1	3.2		
		39	3.2	3.3		
		40	3.3	3.4		
		41	3.4	3.5		
		42	3.5	3.6		
		43	3.6	3.7		

Note:
 Tolerance of Forward Voltage: ±0.05V

Bin Range of Chromaticity Coordinates

CCT	Bin Code	CIE_x	CIE_y	Bin Code	CIE_x	CIE_y
4000K	40K-1	0.4006	0.4044	40K-3	0.3828	0.3803
		0.3871	0.3959		0.3703	0.3726
		0.3828	0.3803		0.3670	0.3578
		0.3952	0.3880		0.3784	0.3647
	40K-2	0.3871	0.3959	40K-4	0.3952	0.3880
		0.3736	0.3874		0.3828	0.3803
		0.3703	0.3726		0.3784	0.3647
		0.3828	0.3803		0.3898	0.3716
3000K	30K-1	0.4562	0.4260	30K-3	0.4345	0.4033
		0.4431	0.4213		0.4223	0.3990
		0.4345	0.4033		0.4147	0.3814
		0.4468	0.4077		0.4260	0.3854
	30K-2	0.4431	0.4213	30K-4	0.4468	0.4077
		0.4299	0.4165		0.4345	0.4033
		0.4223	0.3990		0.4260	0.3854
		0.4345	0.4033		0.4373	0.3893

Note:
 Tolerance of Chromaticity Coordinates: ±0.01

The C.I.E. 1931 Chromaticity Diagram

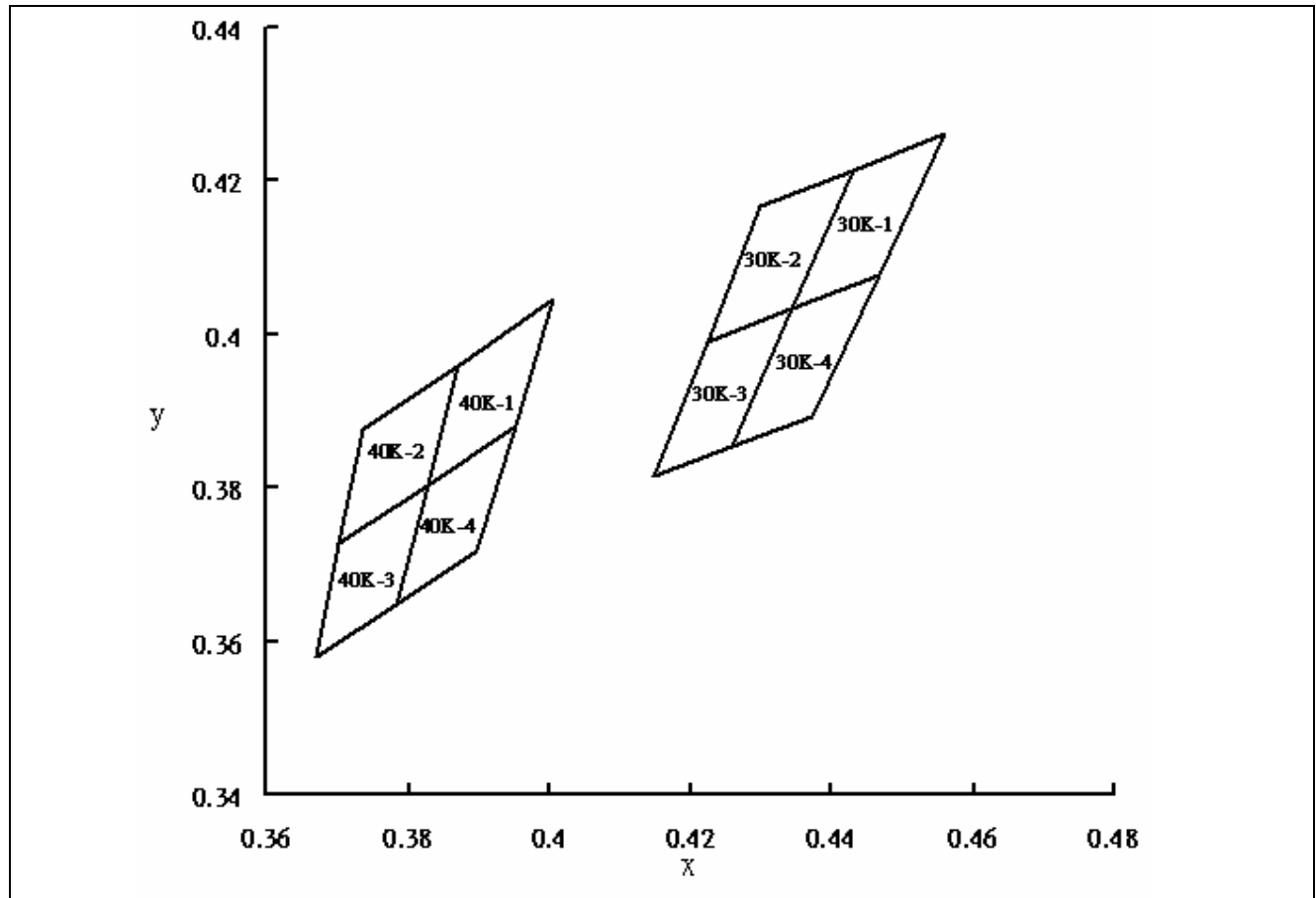

Typical Electro-Optical Characteristics Curves

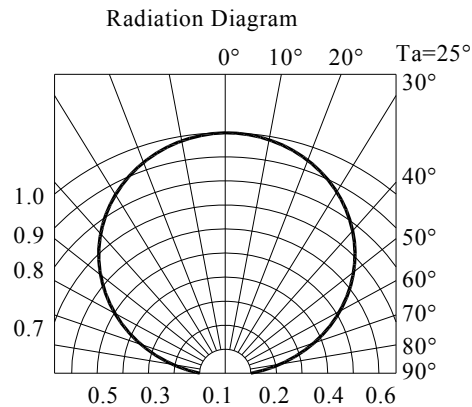
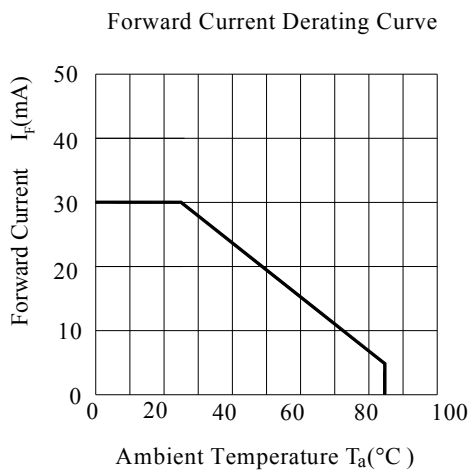
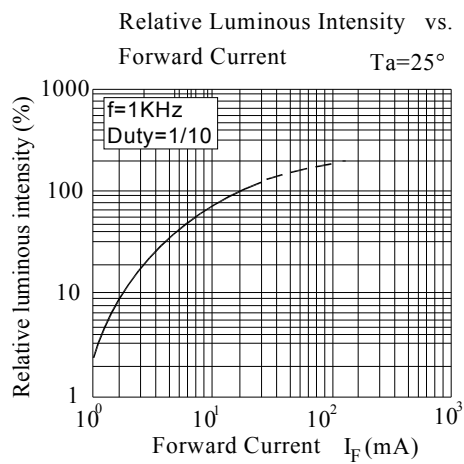
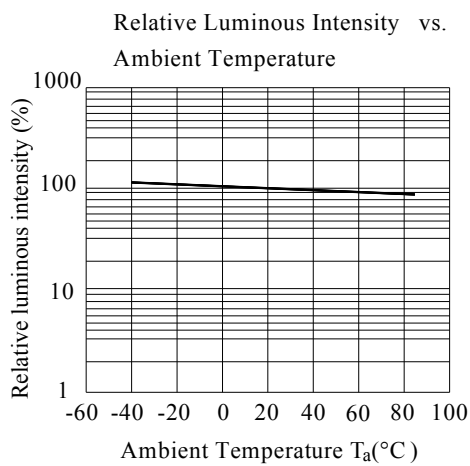
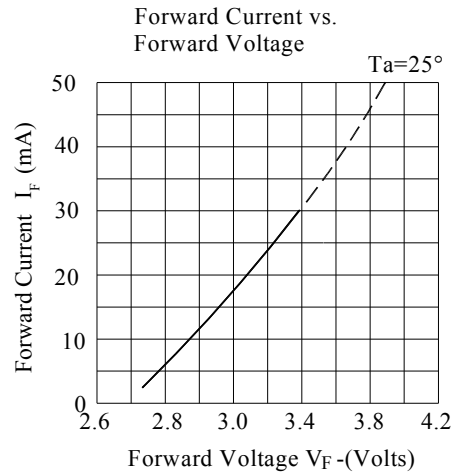
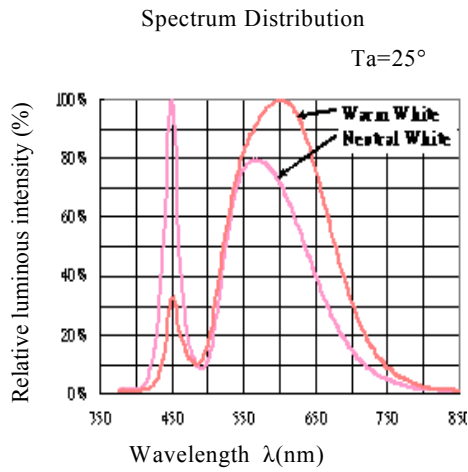

Package Dimension

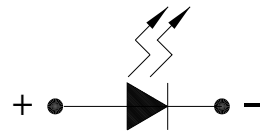
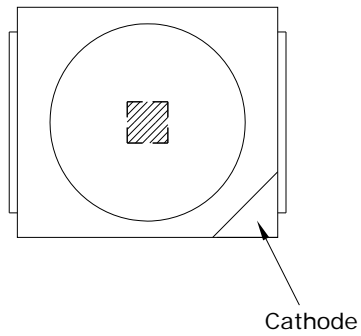

Polarity

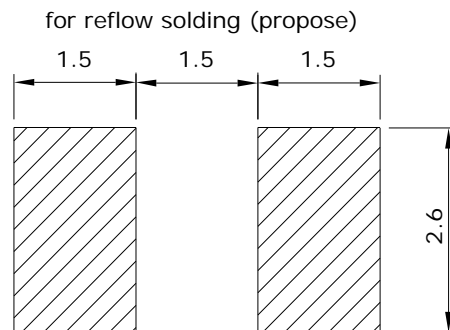
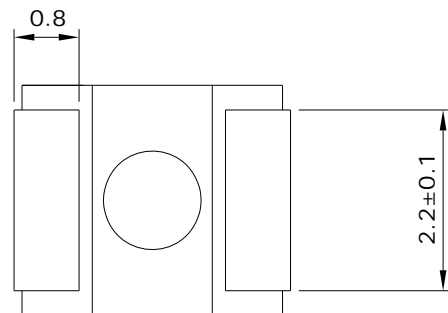
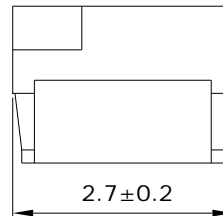
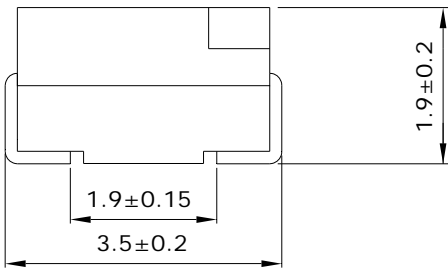

Note:
Tolerance unless mentioned is ± 0.1 mm; Unit = mm

Moisture Resistant Packing Materials

Label Explanation



- CPN: Customer's Product Number
- P/N: Product Number
- QTY: Packing Quantity
- CAT: Luminous Intensity Rank
- HUE: Dom. Wavelength Rank
- REF: Forward Voltage Rank
- LOT No: Lot Number

Reel Dimensions

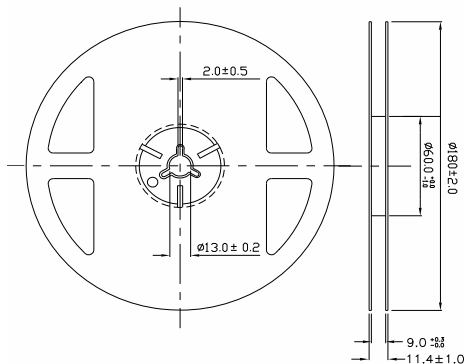

Carrier Tape Dimensions: Loaded Quantity 2000 pcs Per Reel

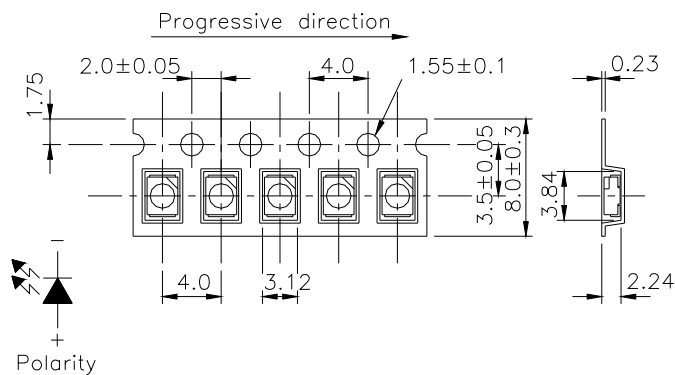

Note:
 Tolerances unless mentioned ± 0.1 mm. Unit = mm

Moisture Resistant Packing Process

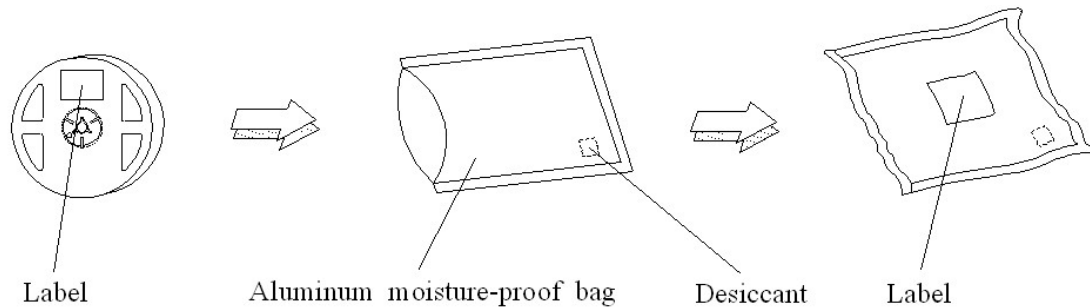

Note:
 Tolerances unless mentioned $\pm 0.1\text{mm}$. Unit = mm

Reliability Test Items and Conditions

The reliability of products shall be satisfied with items listed below.

Confidence level : 90%

LTPD : 10%

No.	Items	Test Condition	Test Hours/Cycles	Sample Size	Ac/Re
1	Reflow Soldering	Temp. : $260^{\circ}\text{C} \pm 5^{\circ}\text{C}$ Min. 10sec.	6 Min.	22 PCS.	0/1
2	Temperature Cycle	H : $+100^{\circ}\text{C}$ 15min ∫ 5 min L : -40°C 15min	300 Cycles	22 PCS.	0/1
3	Thermal Shock	H : $+100^{\circ}\text{C}$ 5min ∫ 10 sec L : -10°C 5min	300 Cycles	22 PCS.	0/1
4	High Temperature Storage	Temp. : 100°C	1000 Hrs.	22 PCS.	0/1
5	Low Temperature Storage	Temp. : -40°C	1000 Hrs.	22 PCS.	0/1
6	DC Operating Life	$I_F = 20\text{ mA}$	1000 Hrs.	22 PCS.	0/1
7	High Temperature / High Humidity	$85^{\circ}\text{C} / 85\% \text{RH}$	1000 Hrs.	22 PCS.	0/1

Precautions for Use

1. Over-current-proof

Customer must apply resistors for protection; otherwise slight voltage shift will cause big current change (Burn out will happen).

2. Storage

2.1 Do not open moisture proof bag before the products are ready to use.

2.2 Before opening the package: The LEDs should be kept at 30°C or less and 90%RH or less.

2.3 After opening the package: The LED's floor life are 168 hours under 30°C or less and 60% RH or less. If unused LEDs remain, it should be stored in moisture proof packages.

2.4 If the moisture absorbent material (silica gel) has faded away or the LEDs have exceeded the storage time, baking treatment should be performed using the following conditions.

Baking treatment: 60±5°C for 24 hours.

3. Soldering Condition

3.1 Pb-free solder temperature profile

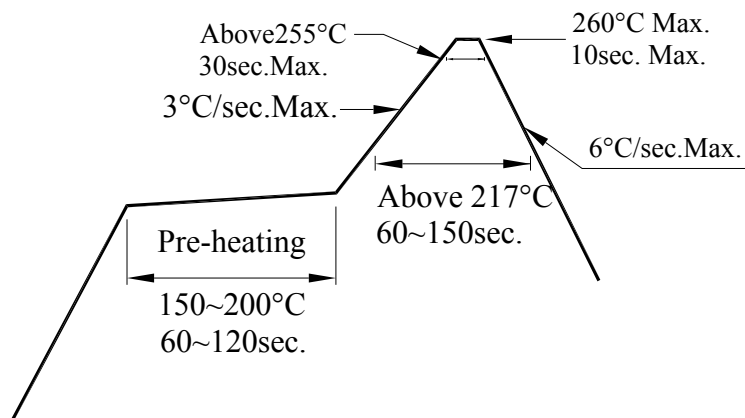

3.2 Reflow soldering should not be done more than two times.

3.3 When soldering, do not put stress on the LEDs during heating.

3.4 After soldering, do not warp the circuit board.

4. Soldering Iron

Each terminal is to go to the tip of soldering iron temperature less than 350°C for 3 seconds within once in less than the soldering iron capacity 25W. Leave two seconds and more intervals, and do soldering of each terminal. Be careful because the damage of the product is often started at the time of the hand solder.

5. Repairing

Repair should not be done after the LEDs have been soldered. When repairing is unavoidable, a double-head soldering iron should be used (as below figure). It should be confirmed beforehand whether the characteristics of the LEDs will or will not be damaged by repairing.

