

NCP4680

150 mA, Low Noise Low Dropout Regulator

The NCP4680 is a CMOS linear voltage regulator with 150 mA output current capability. The device is available in a tiny 0.8x0.8 mm XDFN, and has high output voltage accuracy, low supply current and high ripple rejection. The NCP4680 is easy to use and includes output current fold-back protection. A Chip Enable function is included to save power by lowering supply current. The line and load transient responses are very good, making this regulator ideal for use as a power supply for communication equipment.

Features

- Operating Input Voltage Range: 1.40 V to 5.25 V
- Output Voltage Range: 0.8 V to 3.6 V (available in 0.1 V steps)
- Output Voltage Accuracy: $\pm 1.0\%$
- Supply Current: 50 μA typical
- Dropout Voltage: 0.25 V ($I_{\text{OUT}} = 150 \text{ mA}$, $V_{\text{OUT}} = 2.5 \text{ V}$)
- High PSRR: 75 dB ($f = 1 \text{ kHz}$, $V_{\text{OUT}} = 2.5 \text{ V}$)
- Line Regulation: 0.02%/V Typ.
- Stable with Ceramic Capacitors: 0.1 μF or more
- Current Fold Back Protection
- Available in XDFN4 0.8 x 0.8 mm, SC-70, SOT23 Packages
- These are Pb-Free Devices

Typical Applications

- Battery-powered Equipment
- Networking and Communication Equipment
- Cameras, DVRs, STB and Camcorders
- Home Appliances

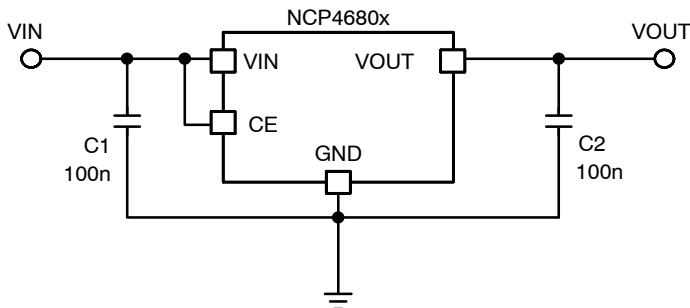

Figure 1. Typical Application Schematic



ON Semiconductor™

<http://onsemi.com>

MARKING DIAGRAMS



SC-70
CASE 419A

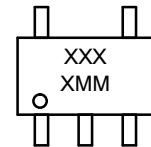

SOT-23-5
CASE 1212

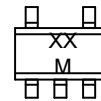

XDFN4
CASE 711AB

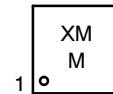

XX, XXX = Specific Device Code
M, MM = Date Code
A = Assembly Location
Y = Year
W = Work Week
▪ = Pb-Free Package

(Note: Microdot may be in either location)

ORDERING INFORMATION

See detailed ordering and shipping information in the package dimensions section on page 17 of this data sheet.

NCP4680

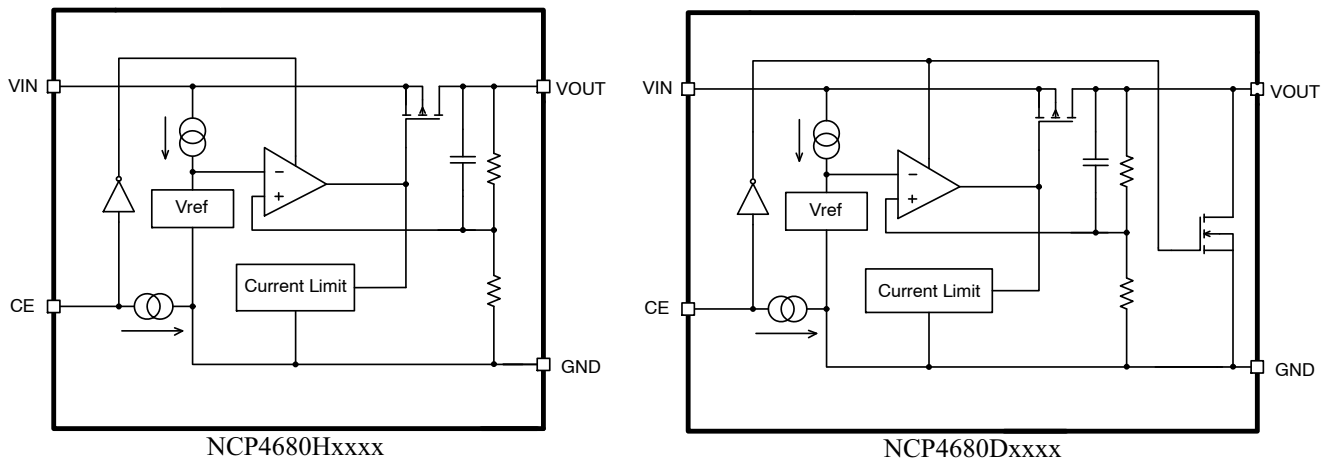

Figure 2. Simplified Schematic Block Diagram

PIN FUNCTION DESCRIPTION

| Pin No. XDFN4* | Pin No. SC-70 | Pin No. SOT23 | Pin Name | Description |
|----------------|---------------|---------------|------------------|------------------------------|
| 1 | 4 | 5 | V _{OUT} | Output pin |
| 2 | 3 | 2 | GND | Ground |
| 3 | 1 | 3 | CE | Chip enable pin (Active "H") |
| 4 | 5 | 1 | V _{IN} | Input pin |
| - | 2 | 4 | NC | No connection |

*Tab is GND level. (They are connected to the reverse side of this IC.
The tab is better to be connected to the GND, but leaving it open is also acceptable.

ABSOLUTE MAXIMUM RATINGS

| Rating | Symbol | Value | Unit |
|---|--------------------|-------------------------------|------|
| Input Voltage (Note 1) | V _{IN} | 6.0 | V |
| Output Voltage | V _{OUT} | -0.3 to V _{IN} + 0.3 | V |
| Chip Enable Input | V _{CE} | 6.0 | V |
| Output Current | I _{OUT} | 180 | mA |
| Power Dissipation XDFN0808 | P _D | 286 | mW |
| Power Dissipation SC-70 | | 380 | |
| Power Dissipation SOT23 | | 420 | |
| Junction Temperature | T _J | -40 to 150 | °C |
| Storage Temperature | T _{STG} | -55 to 125 | °C |
| ESD Capability, Human Body Model (Note 2) | ESD _{HBM} | 2000 | V |
| ESD Capability, Machine Model (Note 2) | ESD _{MM} | 200 | V |

Stresses exceeding Maximum Ratings may damage the device. Maximum Ratings are stress ratings only. Functional operation above the Recommended Operating Conditions is not implied. Extended exposure to stresses above the Recommended Operating Conditions may affect device reliability.

1. Refer to ELECTRICAL CHARACTERISTICS and APPLICATION INFORMATION for Safe Operating Area.
2. This device series incorporates ESD protection and is tested by the following methods:
ESD Human Body Model tested per AEC-Q100-002 (EIA/JESD22-A114)
ESD Machine Model tested per AEC-Q100-003 (EIA/JESD22-A115)
Latch-up Current Maximum Rating tested per JEDEC standard: JESD78.

NCP4680

THERMAL CHARACTERISTICS

| Rating | Symbol | Value | Unit |
|---|-----------------|-------|-----------------------------|
| Thermal Characteristics, XDFN 0.8 x 0.8 mm Thermal Resistance, Junction-to-Air | $R_{\theta JA}$ | 350 | $^{\circ}\text{C}/\text{W}$ |
| Thermal Characteristics, SOT23 Thermal Resistance, Junction-to-Air | $R_{\theta JA}$ | 238 | $^{\circ}\text{C}/\text{W}$ |
| Thermal Characteristics, SC-70 Thermal Resistance, Junction-to-Air | $R_{\theta JA}$ | 263 | $^{\circ}\text{C}/\text{W}$ |

ELECTRICAL CHARACTERISTICS

$-40^{\circ}\text{C} \leq T_A \leq 85^{\circ}\text{C}$; $V_{IN} = V_{OUT(NOM)} + 1\text{ V}$ or 2.5 V , whichever is greater; $I_{OUT} = 1\text{ mA}$, $C_{IN} = C_{OUT} = 0.1\text{ }\mu\text{F}$, unless otherwise noted.
Typical values are at $T_A = +25^{\circ}\text{C}$.

| Parameter | Test Conditions | Symbol | Min | Typ | Max | Unit |
|--|---|-----------------------------|-----------------------------|-----------|----------------------|-------------------------|
| Operating Input Voltage | | V_{IN} | 1.40 | | 5.25 | V |
| Output Voltage | $T_A = +25^{\circ}\text{C}$ | $V_{OUT} \geq 1.8\text{ V}$ | V_{OUT} | x0.99 | x1.01 | V |
| | | | | -18 | 18 | mV |
| | $-40^{\circ}\text{C} \leq T_A \leq 85^{\circ}\text{C}$ | $V_{OUT} \geq 1.8\text{ V}$ | x0.985 | x1.015 | V | |
| | | | -50 | 50 | mV | |
| Output Voltage Temp. Coefficient | $-40^{\circ}\text{C} \leq T_A \leq 85^{\circ}\text{C}$ | $V_{OUT} \geq 1.8\text{ V}$ | $\Delta V_{OUT}/\Delta T_A$ | ± 30 | | ppm/ $^{\circ}\text{C}$ |
| | | | | ± 100 | | |
| Line Regulation | $V_{OUT(NOM)} + 0.5\text{ V} \leq V_{IN} \leq 5.25\text{ V}$, $V_{IN} \geq 1.4\text{ V}$ | Line_{Reg} | | 0.02 | 0.10 | %/V |
| Load Regulation | $I_{OUT} = 1\text{ mA}$ to 150 mA | Load_{Reg} | | 5 | 30 | mV |
| Dropout Voltage | $I_{OUT} = 150\text{ mA}$ | V_{DO} | | 0.70 | 1.00 | V |
| | | | | 0.62 | 0.91 | |
| | | | | 0.56 | 0.82 | |
| | | | | 0.47 | 0.67 | |
| | | | | 0.39 | 0.54 | |
| | | | | 0.33 | 0.48 | |
| | | | | 0.28 | 0.40 | |
| | | | | 0.25 | 0.35 | |
| | | | | 0.23 | 0.32 | |
| Output Current | | I_{OUT} | 150 | | | mA |
| Short Current Limit | $V_{OUT} = 0\text{ V}$ | I_{SC} | | 40 | | mA |
| Quiescent Current | | I_Q | | 50 | 70 | μA |
| Standby Current | $V_{CE} = 0\text{ V}$, $T_A = 25^{\circ}\text{C}$ | I_{STB} | | 0.1 | 1.0 | μA |
| CE Pin Threshold Voltage | CE Input Voltage "H" | V_{CEH} | 1.0 | | | V |
| | CE Input Voltage "L" | V_{CEL} | | | 0.4 | |
| CE Pull Down Current | | I_{CEPD} | | 0.3 | | μA |
| Power Supply Rejection Ratio | $V_{IN} = V_{OUT} + 1\text{ V}$, $\Delta V_{IN} = 0.2\text{ V}_{pk-pk}$, $I_{OUT} = 30\text{ mA}$, $f = 1\text{ kHz}$ | PSRR | | 75 | | dB |
| Output Noise Voltage | $f = 10\text{ Hz}$ to 100 kHz , $I_{OUT} = 30\text{ mA}$ | $V_{OUT} \geq 1.8\text{ V}$ | V_N | | $20 \times V_{OUT}$ | μV_{rms} |
| | | | | | $40 \times V_{OUT}$ | |
| Low Output N-channel Tr. On Resistance | $V_{IN} = 4\text{ V}$, $V_{CE} = 0\text{ V}$ | R_{LOW} | | 60 | | Ω |
| Minimum Start-up Equivalent Resistance | $V_{OUT} \leq 1.8\text{ V}$ (Note 3) | R_{SUMIN} | | | $13 \times V_{OUT}$ | Ω |
| | $V_{OUT} > 1.8\text{ V}$ | | | | $6.7 \times V_{OUT}$ | |

3. See Current Limit paragraph in application part for explanation.

TYPICAL CHARACTERISTICS

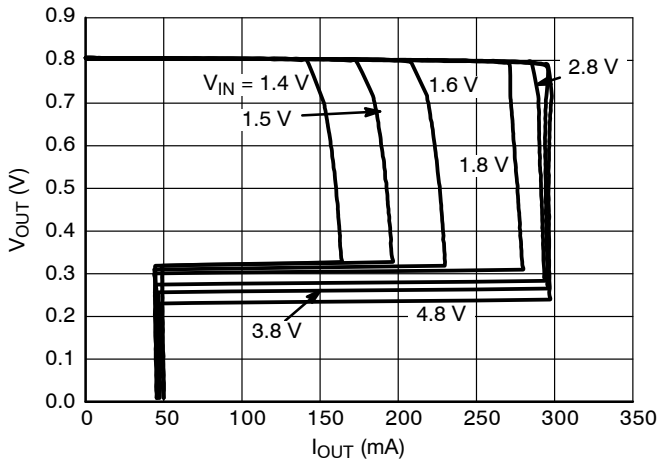

Figure 3. Output Voltage vs. Output Current
0.8 V Version ($T_J = 25^\circ\text{C}$)

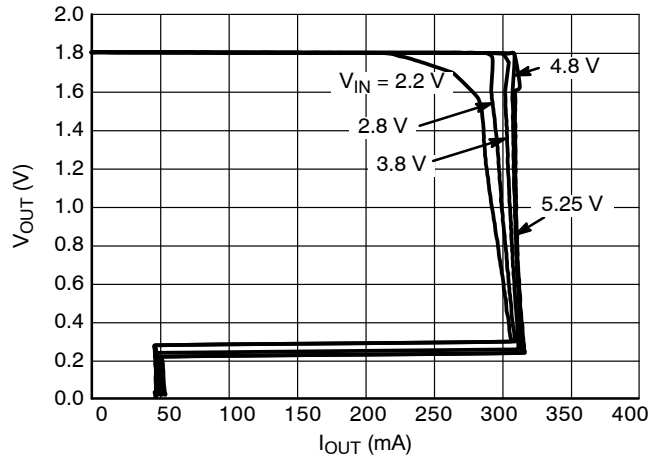

Figure 4. Output Voltage vs. Output Current
1.8 V Version ($T_J = 25^\circ\text{C}$)

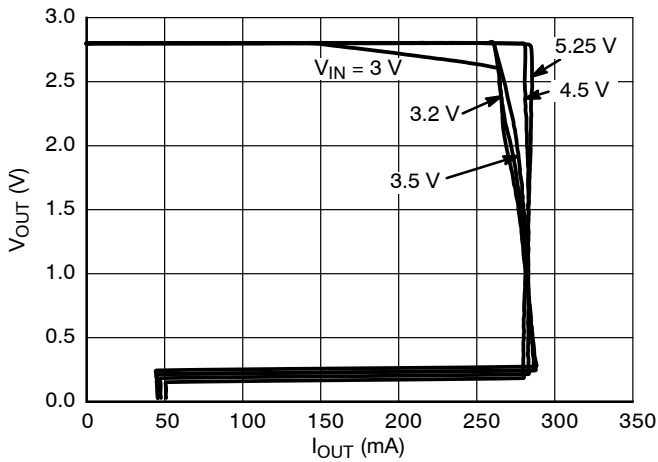

Figure 5. Output Voltage vs. Output Current
2.8 V Version ($T_J = 25^\circ\text{C}$)

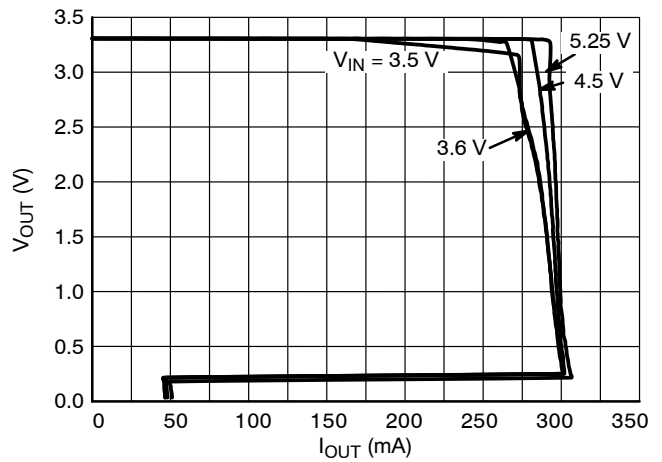

Figure 6. Output Voltage vs. Output Current
3.3 V Version ($T_J = 25^\circ\text{C}$)

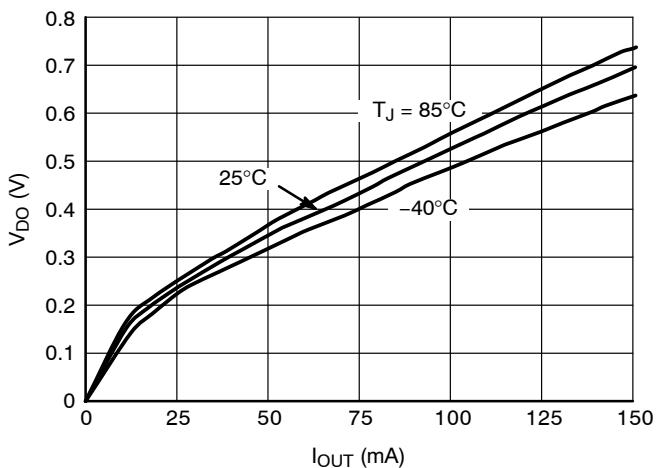

Figure 7. Dropout Voltage vs. Output Current
0.8 V Version

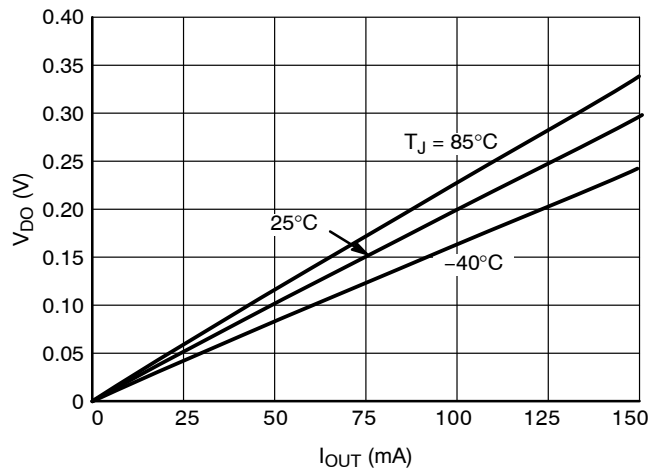

Figure 8. Dropout Voltage vs. Output Current
1.8 V Version

TYPICAL CHARACTERISTICS

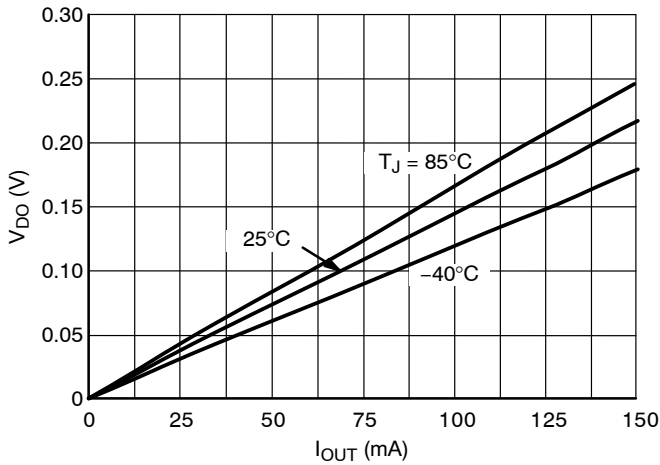

Figure 9. Dropout Voltage vs. Output Current
2.8 V Version

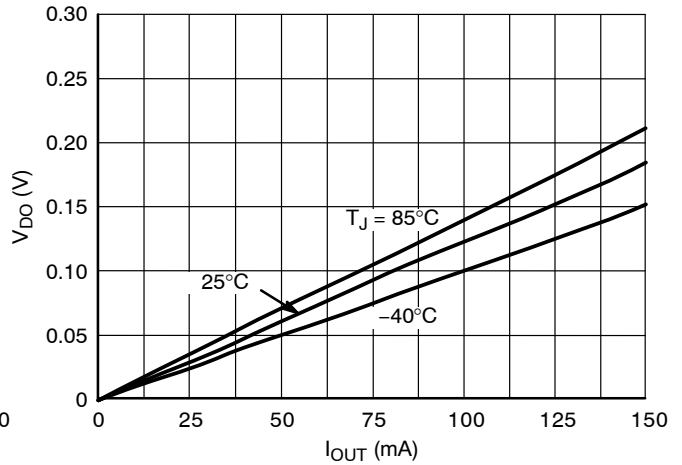

Figure 10. Dropout Voltage vs. Output Current
3.3 V Version

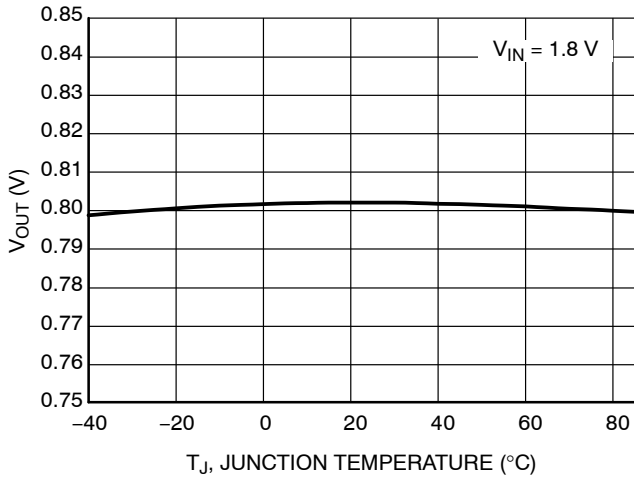

Figure 11. Output Voltage vs. Temperature,
0.8 V Version

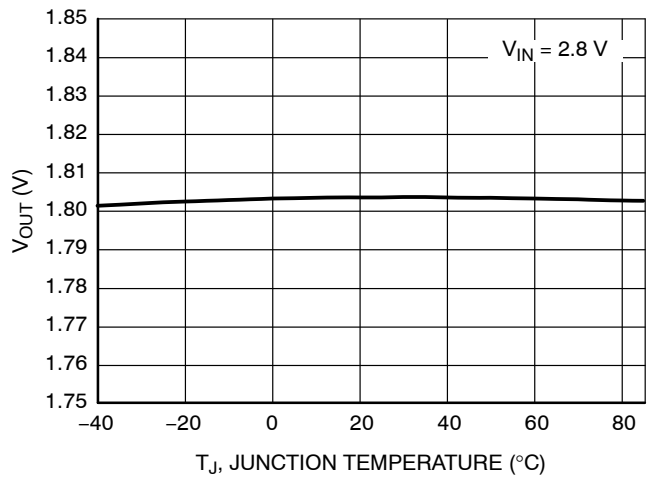

Figure 12. Output Voltage vs. Temperature,
1.8 V Version

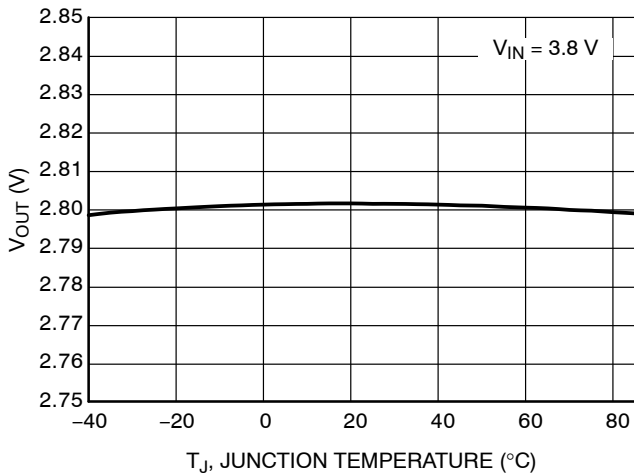

Figure 13. Output Voltage vs. Temperature,
2.8 V Version

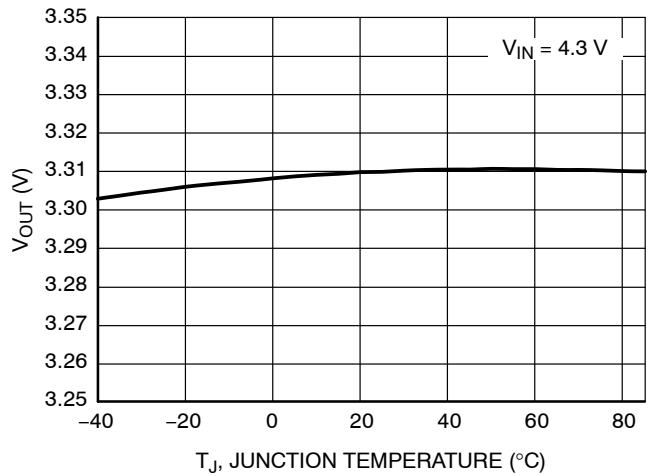

Figure 14. Output Voltage vs. Temperature,
3.3 V Version

TYPICAL CHARACTERISTICS

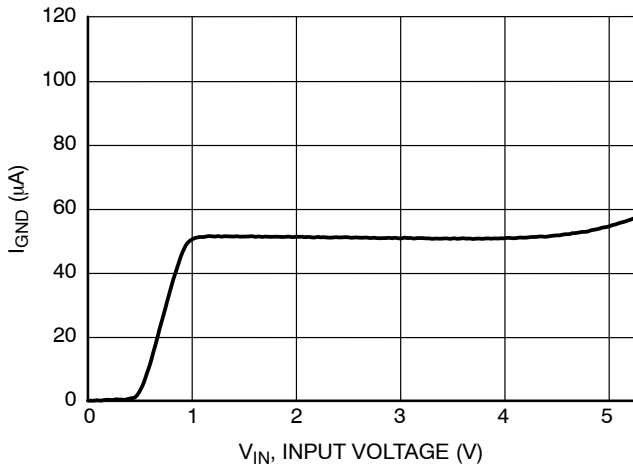

Figure 15. Supply Current vs. Input Voltage, 0.8 V Version

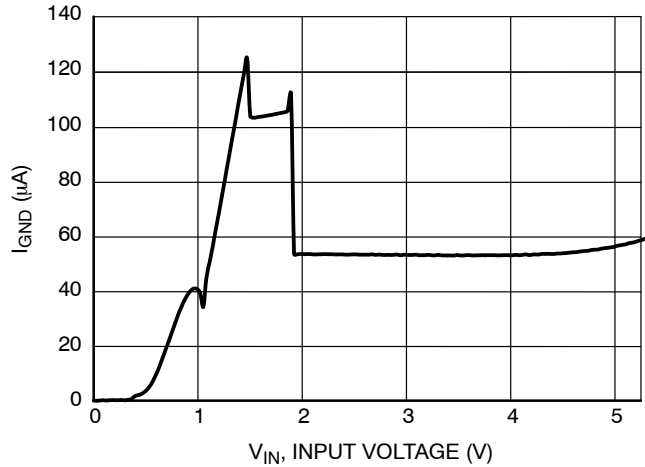

Figure 16. Supply Current vs. Input Voltage, 1.8 V Version

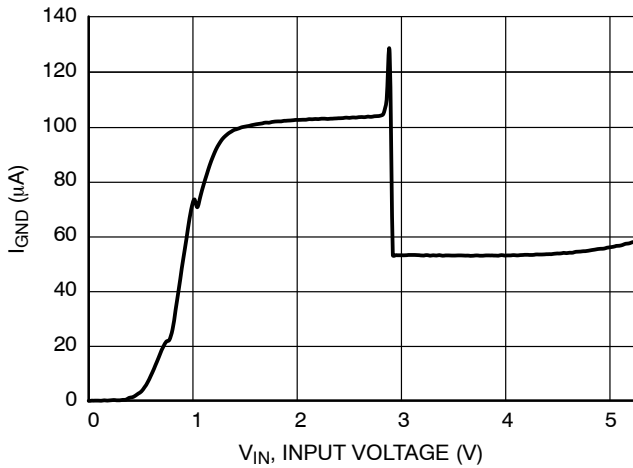

Figure 17. Supply Current vs. Input Voltage, 2.8 V Version

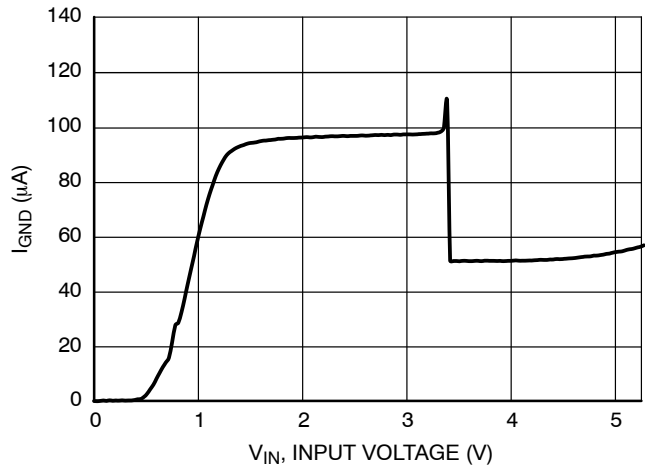

Figure 18. Supply Current vs. Input Voltage, 3.3 V Version

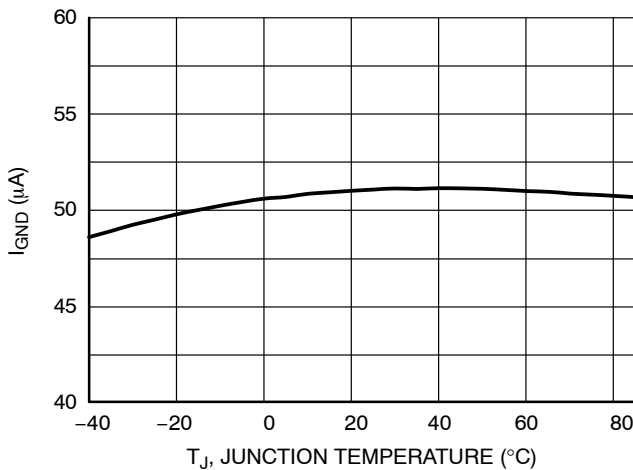

Figure 19. Supply Current vs. Temperature, 0.8 V Version

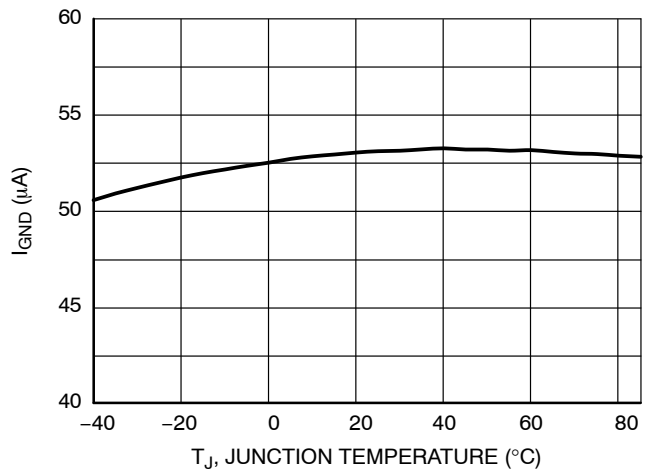

Figure 20. Supply Current vs. Temperature, 1.8 V Version

NCP4680

TYPICAL CHARACTERISTICS

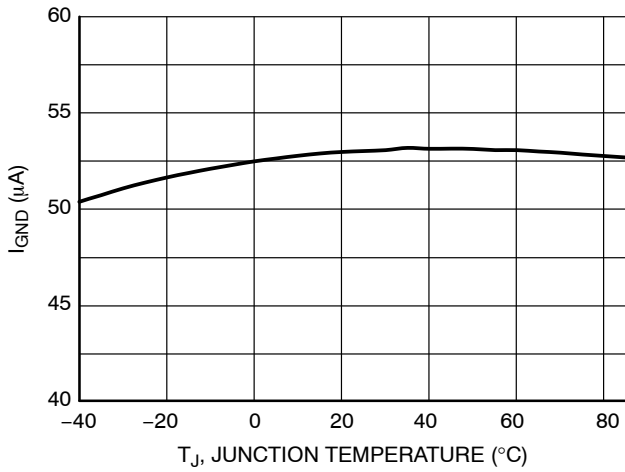

Figure 21. Supply Current vs. Temperature, 2.8 V Version

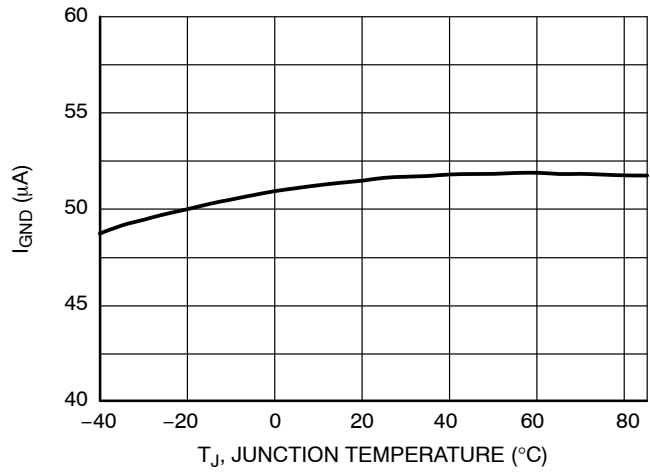

Figure 22. Supply Current vs. Temperature, 3.3 V Version

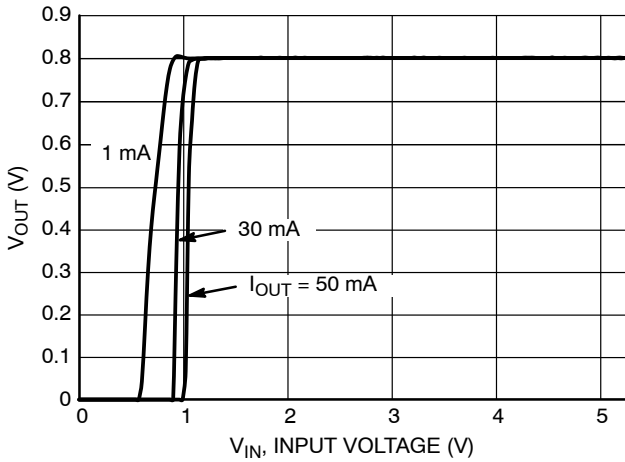

Figure 23. Output Voltage vs. Input Voltage, 0.8 V Version

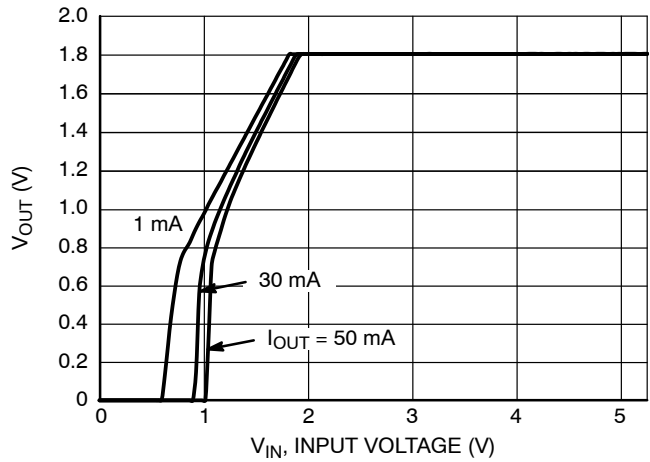

Figure 24. Output Voltage vs. Input Voltage, 1.8 V Version

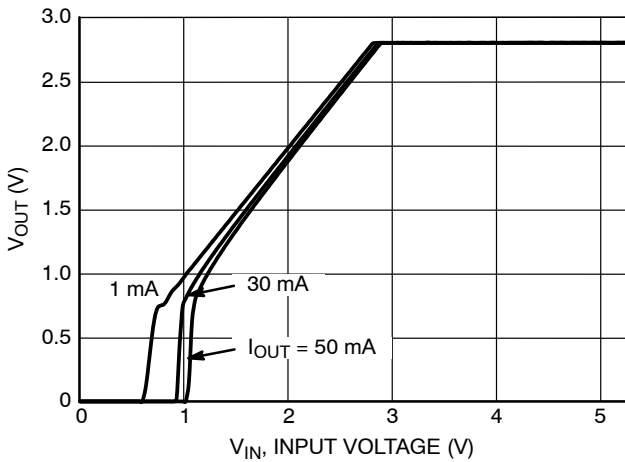

Figure 25. Output Voltage vs. Input Voltage, 2.8 V Version

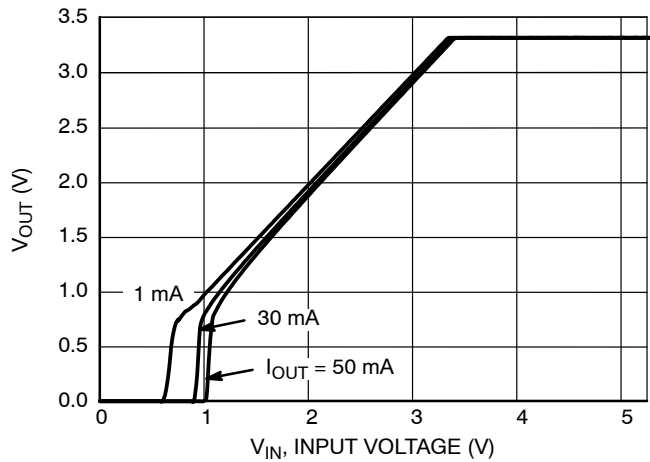

Figure 26. Output Voltage vs. Input Voltage, 3.3 V Version

TYPICAL CHARACTERISTICS

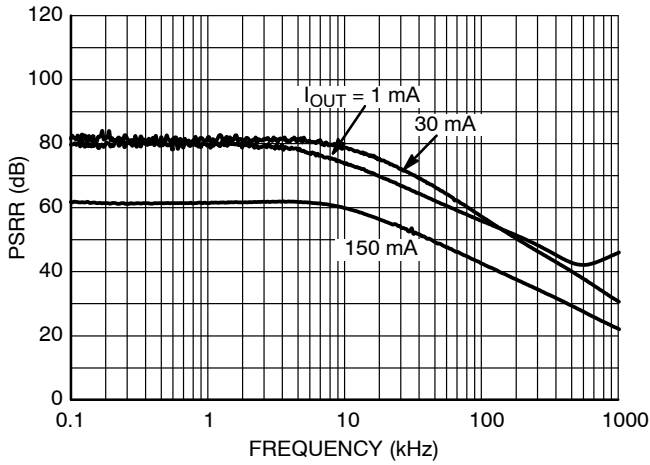

Figure 27. PSRR, 0.8 V Version, $V_{IN} = 1.8\text{ V}$

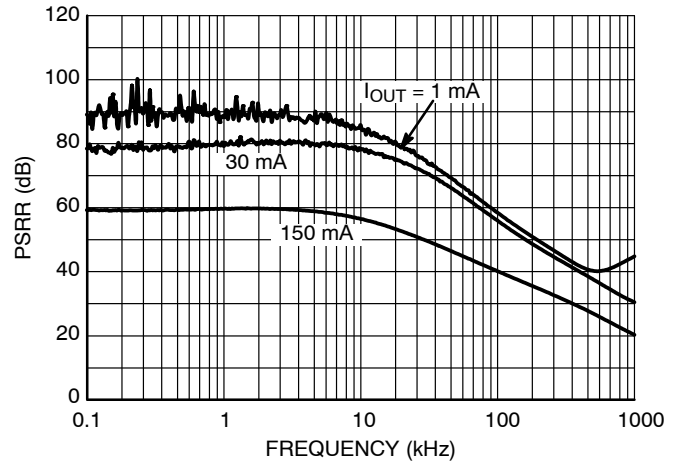

Figure 28. PSRR, 1.8 V Version, $V_{IN} = 2.8\text{ V}$

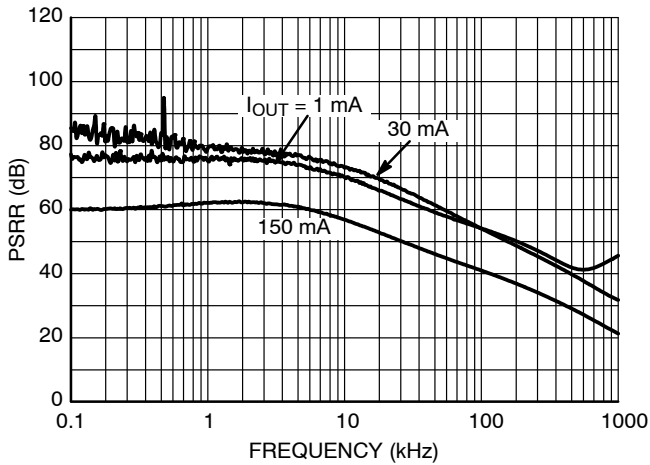

Figure 29. PSRR, 2.8 V Version, $V_{IN} = 3.8\text{ V}$

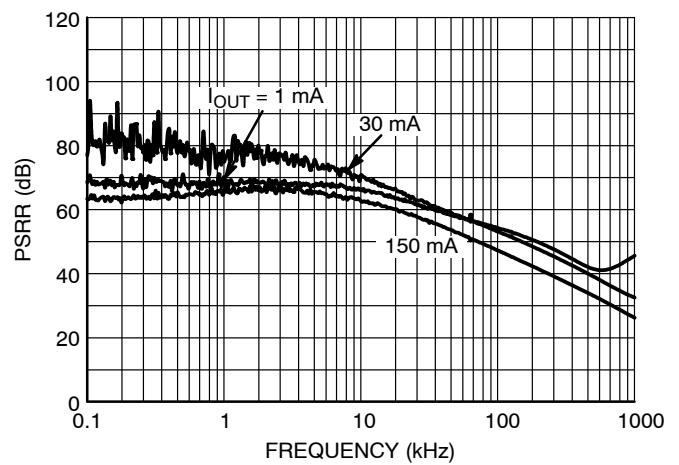

Figure 30. PSRR, 3.3 V Version, $V_{IN} = 4.3\text{ V}$

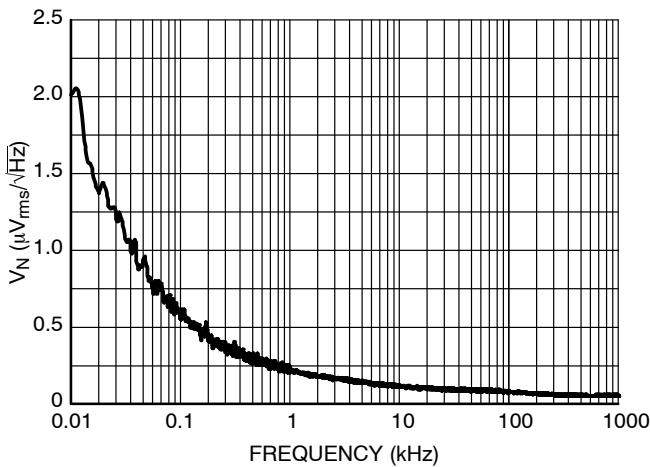

Figure 31. Output Voltage Noise, 0.8 V Version, $V_{IN} = 1.8\text{ V}$

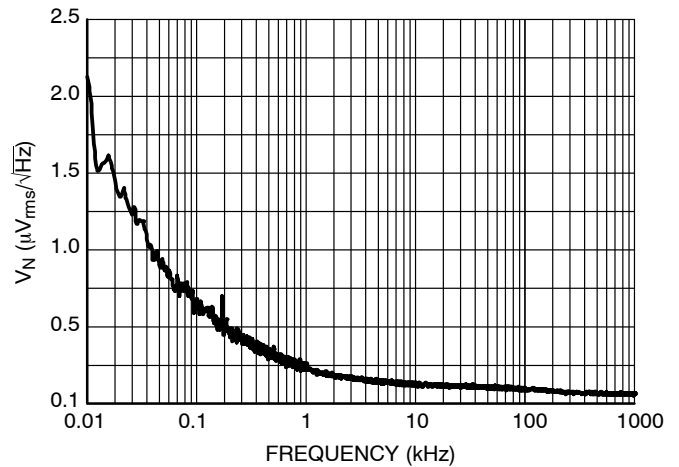

Figure 32. Output Voltage Noise, 1.8 V Version, $V_{IN} = 2.8\text{ V}$

TYPICAL CHARACTERISTICS

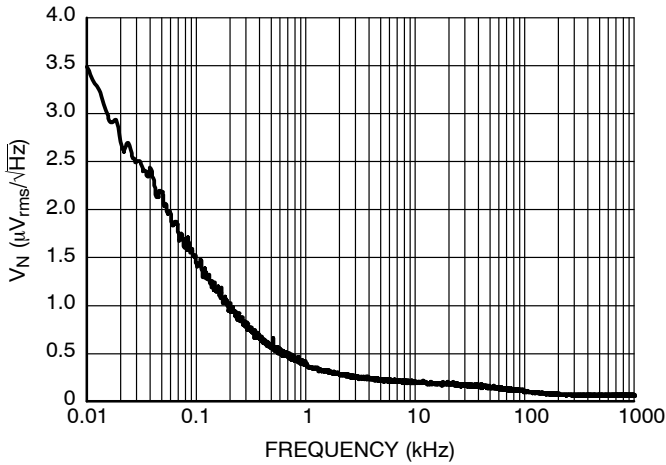

Figure 33. Output Voltage Noise, 2.8 V Version, $V_{IN} = 3.8\text{ V}$

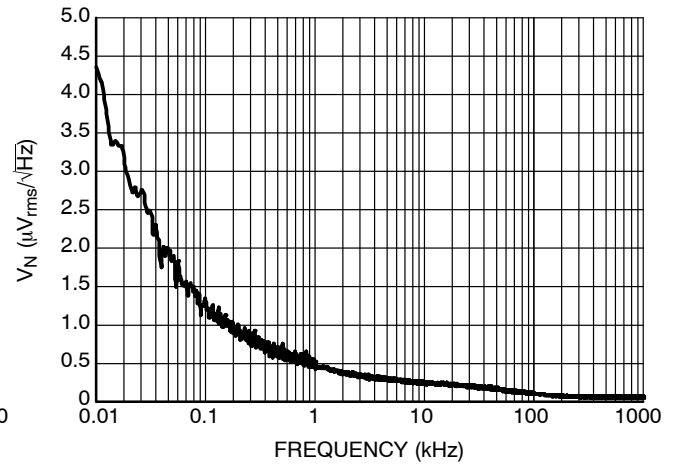

Figure 34. Output Voltage Noise, 3.3 V Version, $V_{IN} = 4.3\text{ V}$

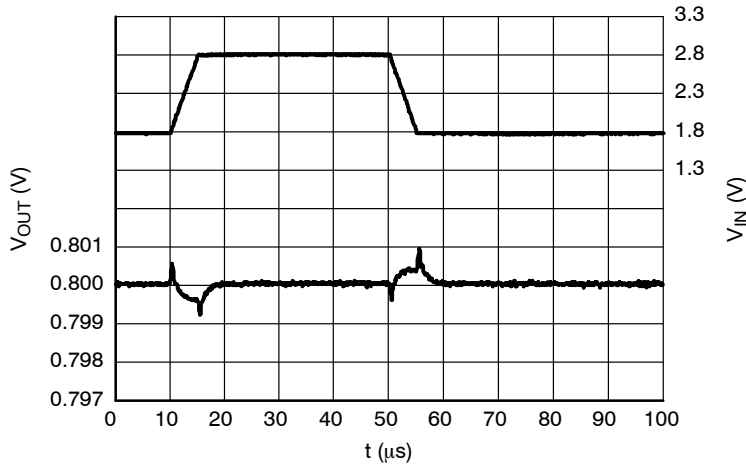

Figure 35. Line Transients, 0.8 V Version, $t_R = t_F = 5\ \mu\text{s}$, $I_{OUT} = 30\text{ mA}$

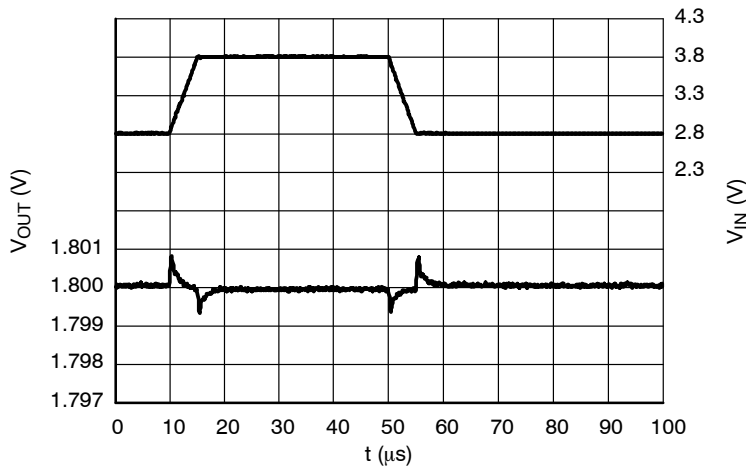
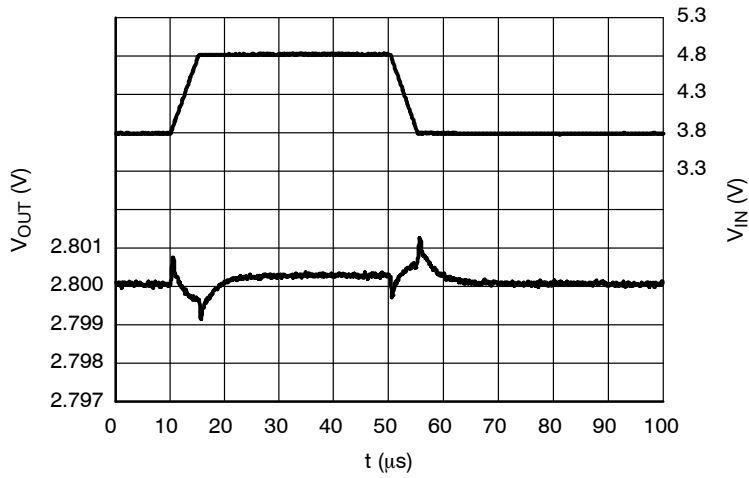

Figure 36. Line Transients, 1.8 V Version, $t_R = t_F = 5\ \mu\text{s}$, $I_{OUT} = 30\text{ mA}$

NCP4680

TYPICAL CHARACTERISTICS



**Figure 37. Line Transients, 2.8 V Version,
 $t_R = t_F = 5 \mu s$, $I_{OUT} = 30 \text{ mA}$**

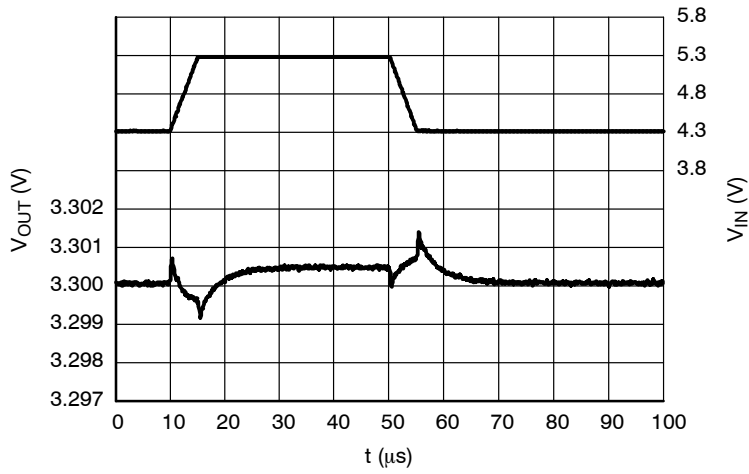

**Figure 38. Line Transients, 3.3 V Version,
 $t_R = t_F = 5 \mu s$, $I_{OUT} = 30 \text{ mA}$**

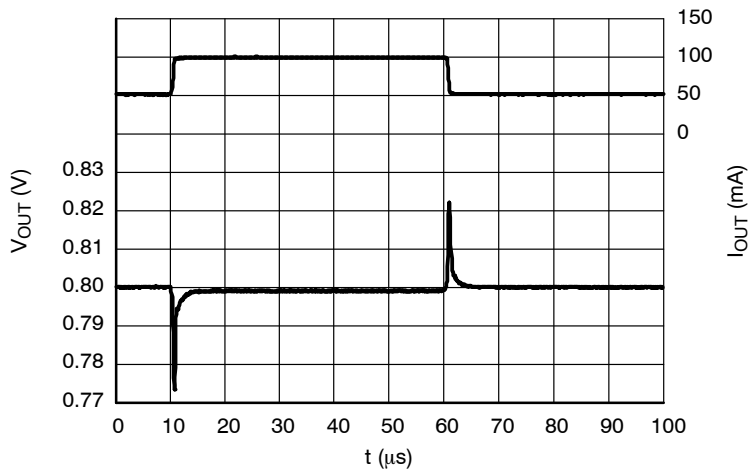

**Figure 39. Load Transients, 0.8 V Version,
 $I_{OUT} = 50 - 100 \text{ mA}$, $t_R = t_F = 0.5 \mu s$, $V_{IN} = 1.8 \text{ V}$**

NCP4680

TYPICAL CHARACTERISTICS

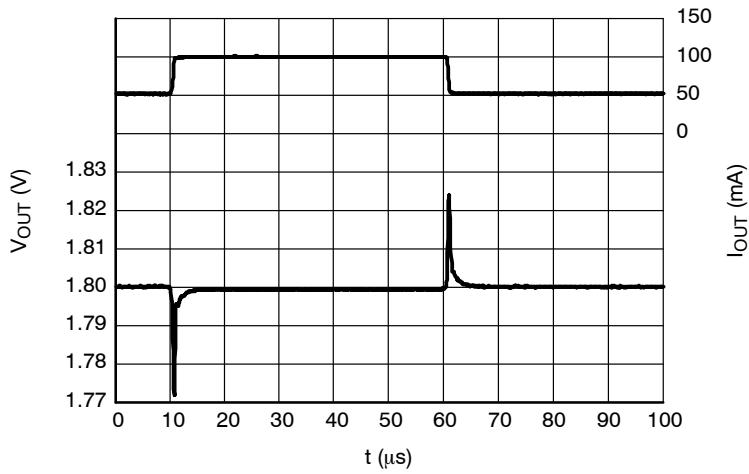

**Figure 40. Load Transients, 1.8 V Version,
 $I_{OUT} = 50 - 100 \text{ mA}$, $t_R = t_F = 0.5 \mu\text{s}$, $V_{IN} = 2.8 \text{ V}$**

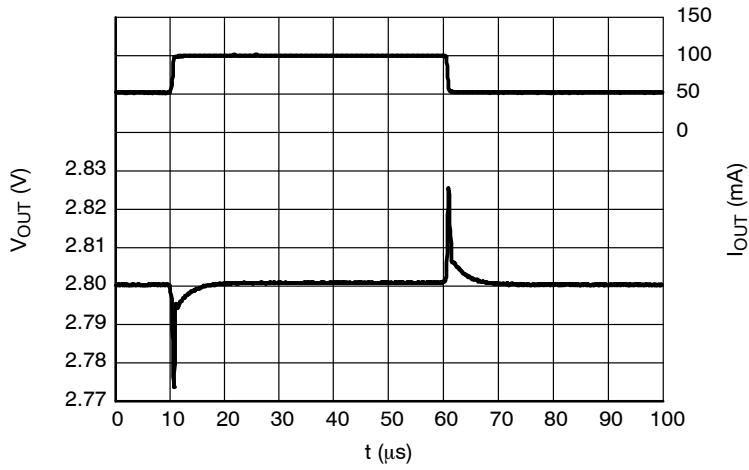

**Figure 41. Load Transients, 2.8 V Version,
 $I_{OUT} = 50 - 100 \text{ mA}$, $t_R = t_F = 0.5 \mu\text{s}$, $V_{IN} = 3.8 \text{ V}$**

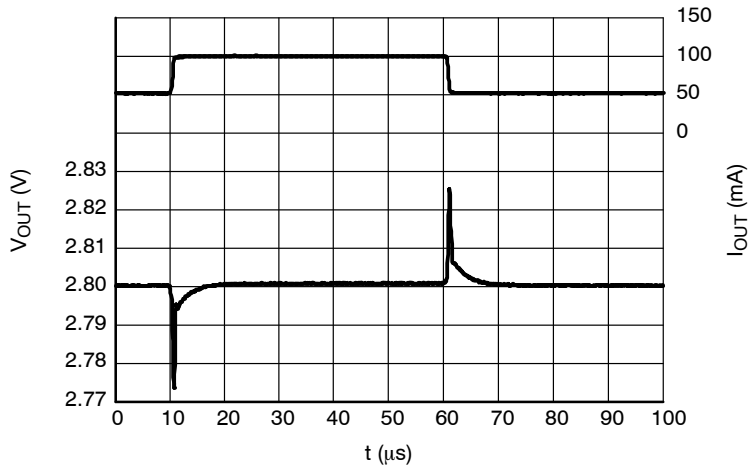

**Figure 42. Load Transients, 3.3 V Version,
 $I_{OUT} = 50 - 100 \text{ mA}$, $t_R = t_F = 0.5 \mu\text{s}$, $V_{IN} = 4.3 \text{ V}$**

NCP4680

TYPICAL CHARACTERISTICS

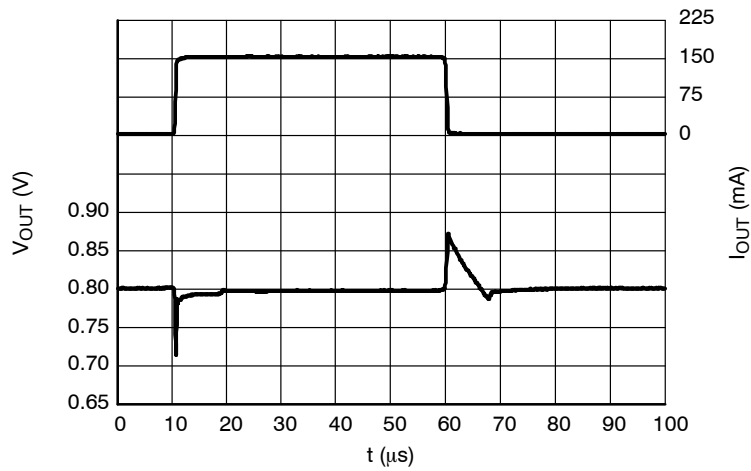

**Figure 43. Load Transients, 0.8 V Version,
 $I_{OUT} = 1 - 150$ mA, $t_R = t_F = 0.5 \mu$ s, $V_{IN} = 1.8$ V**

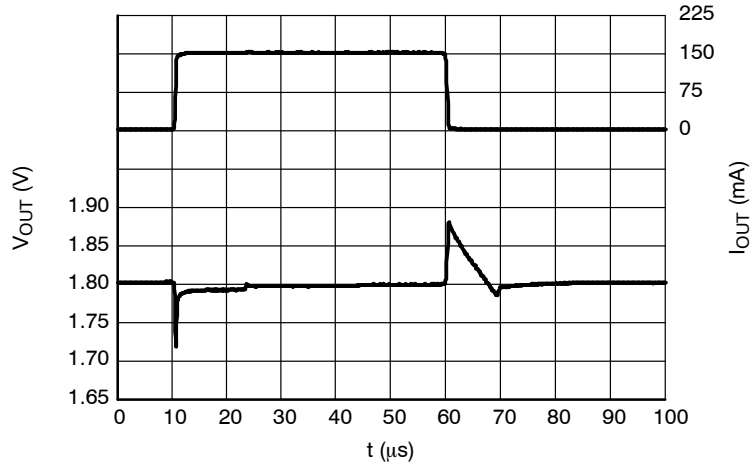

**Figure 44. Load Transients, 1.8 V Version,
 $I_{OUT} = 1 - 150$ mA, $t_R = t_F = 0.5 \mu$ s, $V_{IN} = 2.8$ V**

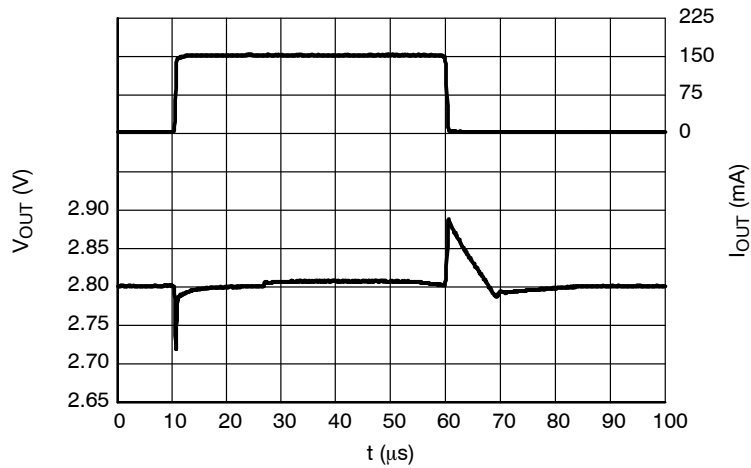

**Figure 45. Load Transients, 2.8 V Version,
 $I_{OUT} = 1 - 150$ mA, $t_R = t_F = 0.5 \mu$ s, $V_{IN} = 3.8$ V**

NCP4680

TYPICAL CHARACTERISTICS

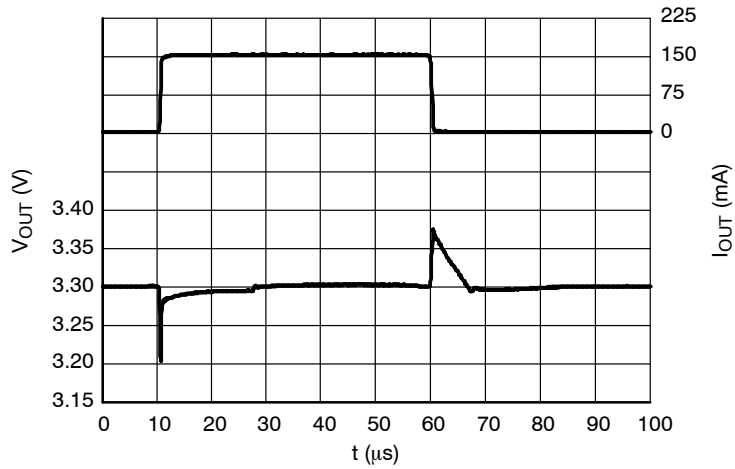

Figure 46. Load Transients, 3.3 V Version, $I_{OUT} = 1 - 150$ mA, $t_R = t_F = 0.5 \mu$ s, $V_{IN} = 4.3$ V

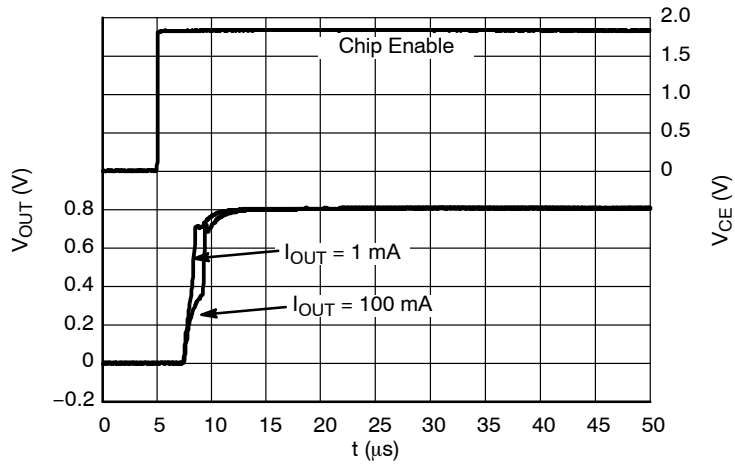

Figure 47. Start-up, 0.8 V Version, $V_{IN} = 1.8$ V

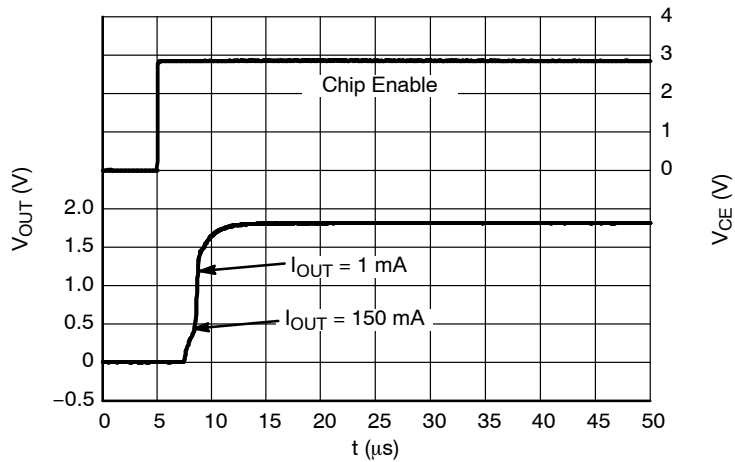

Figure 48. Start-up, 1.8 V Version, $V_{IN} = 2.8$ V

NCP4680

TYPICAL CHARACTERISTICS

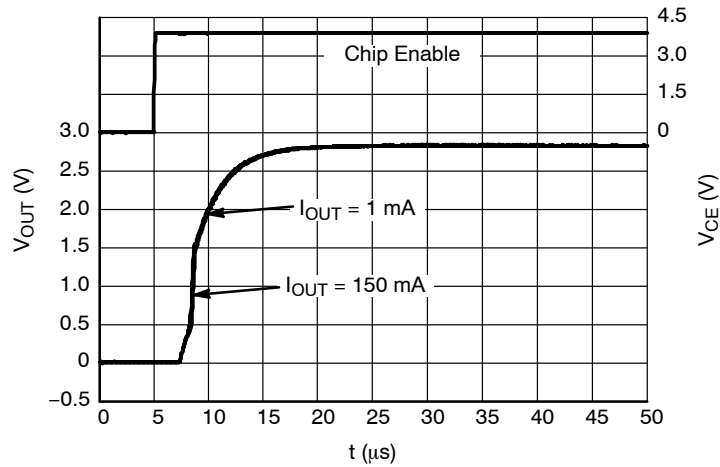

Figure 49. Start-up, 2.8 V Version, $V_{IN} = 3.8\text{ V}$

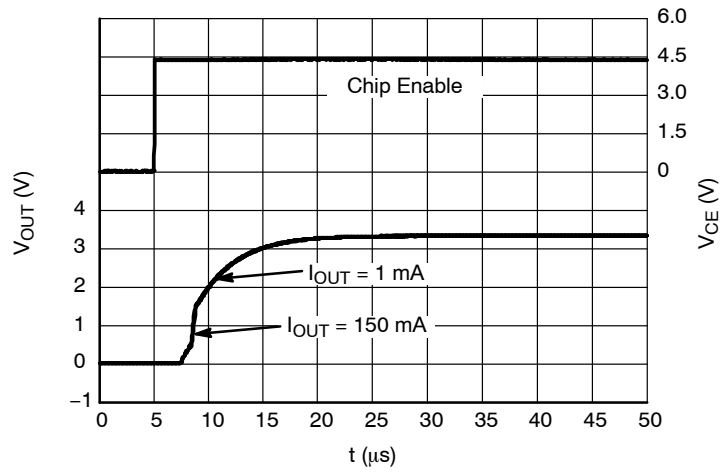

Figure 50. Start-up, 3.3 V Version, $V_{IN} = 4.3\text{ V}$

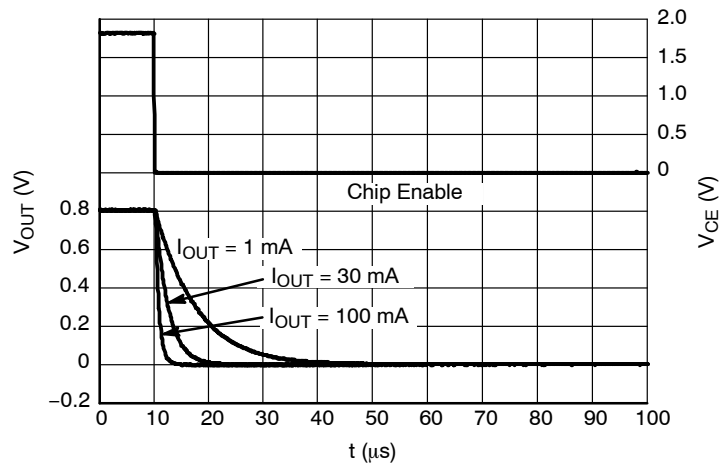
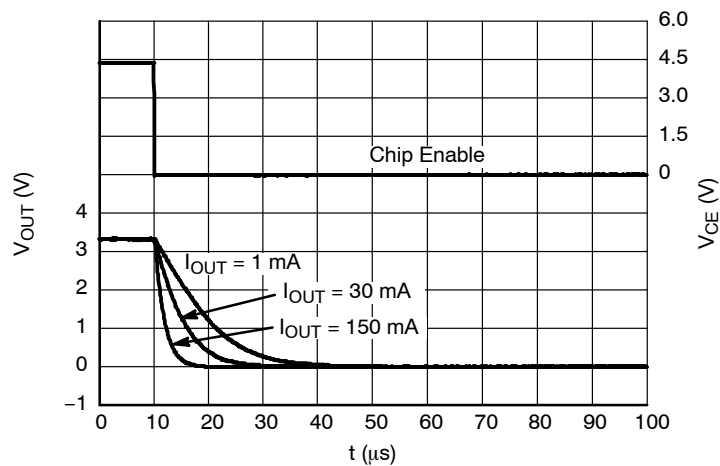
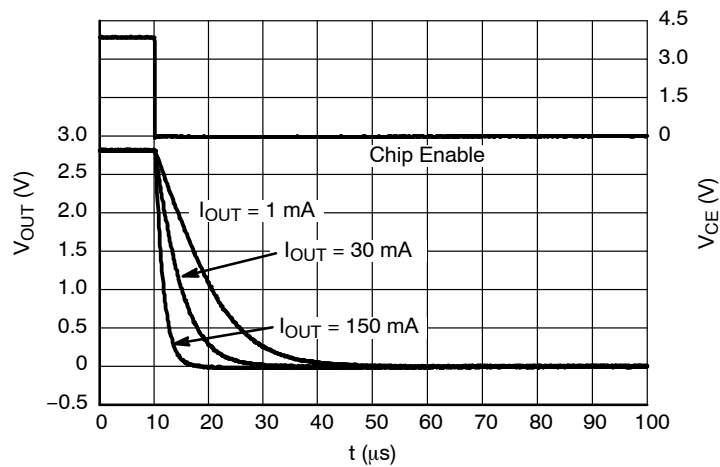
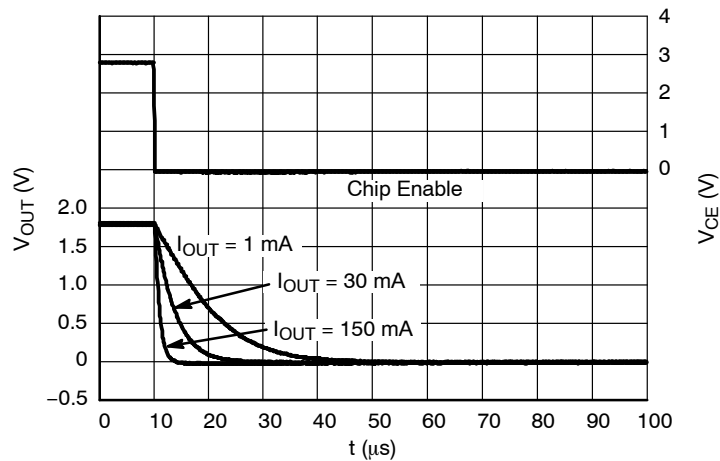

Figure 51. Shutdown, 0.8 V Version D, $V_{IN} = 1.8\text{ V}$

NCP4680

TYPICAL CHARACTERISTICS



APPLICATION INFORMATION

A typical application circuit for NCP4680 series is shown in Figure 55.

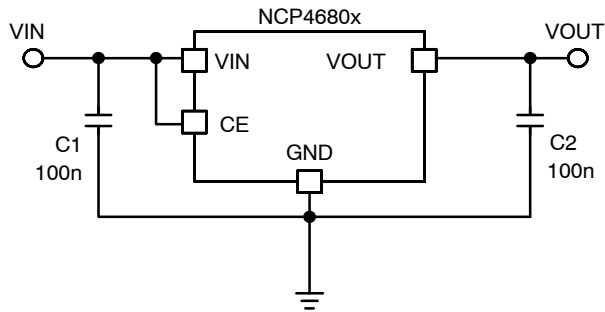

Figure 55. Typical Application Schematic

Input Decoupling Capacitor (C1)

A 0.1 μF ceramic input decoupling capacitor should be connected as close as possible to the input and ground pin of the NCP4680. Higher values and lower ESR improves line transient response.

Output Decoupling Capacitor (C2)

A 0.1 μF ceramic output decoupling capacitor is enough to achieve stable operation of the IC. If a tantalum capacitor is used, and its ESR is high, loop oscillation may result. The capacitors should be connected as close as possible to the output and ground pins. Larger values and lower ESR improves dynamic parameters.

Current Limit

The NCP4680 includes fold-back type current limit protection. Its typical characteristic for 0.8 V version is shown in Figure 3. The advantage of this protection is that power loss at the regulator is minimized at over current or short circuit conditions. When the over current or short circuit event disappears, the regulator reverts from fold back to regulation. This kind of current limit may cause issues at start-up for voltage versions below 1.8 V and some load types: for these lower voltage options it is recommended to

start-up into at least double the minimum equivalent load. The minimum equivalent resistance can be computed by formula 1:

$$R_{\text{EQMIN}} = \frac{V_{\text{OUT(NOM)}}}{I_{\text{OUTMAX}}} \quad (\text{eq. 1})$$

This leads us to the result that the minimum equivalent start up resistance for $V_{\text{OUT(NOM)}} < 1.8 \text{ V}$ is:

$$R_{\text{SUMIN}} = 2 \cdot R_{\text{EQMIN}} \quad (\text{eq. 2})$$

Enable Operation

The enable pin CE may be used for turning the regulator on and off. The IC is switched on when a high level voltage is applied to the CE pin. The enable pin has an internal pull down current source. If the enable function is not needed connect CE pin to VIN.

Output Discharger

The D version includes a transistor between VOUT and GND that is used for faster discharging of the output capacitor. This function is activated when the IC goes into disable mode.

Thermal

As power across the IC increase, it might become necessary to provide some thermal relief. The maximum power dissipation supported by the device is dependent upon board design and layout. Mounting pad configuration on the PCB, the board material, and also the ambient temperature affect the rate of temperature increase for the part. When the device has good thermal conductivity through the PCB the junction temperature will be relatively low in high power dissipation applications.

PCB layout

Make the VIN and GND line as large as practical. If their impedance is high, noise pickup or unstable operation may result. Connect capacitors C1 and C2 as close as possible to the IC, and make wiring as short as possible.

NCP4680

ORDERING INFORMATION

| Device | Nominal Output Voltage | Description | Marking | Package | Shipping [†] |
|-----------------|------------------------|----------------|------------|-----------------|-----------------------|
| NCP4680DMX10TCG | 1.0 V | Auto discharge | A (fixed)* | XDFN4 (Pb-Free) | 10000 / Tape & Reel |
| NCP4680DMX12TCG | 1.2 V | Auto discharge | A (fixed)* | XDFN4 (Pb-Free) | 10000 / Tape & Reel |
| NCP4680DMX15TCG | 1.5 V | Auto discharge | A (fixed)* | XDFN4 (Pb-Free) | 10000 / Tape & Reel |
| NCP4680DMX18TCG | 1.8 V | Auto discharge | A (fixed)* | XDFN4 (Pb-Free) | 10000 / Tape & Reel |
| NCP4680DMX23TCG | 2.3 V | Auto discharge | A (fixed)* | XDFN4 (Pb-Free) | 10000 / Tape & Reel |
| NCP4680DMX28TCG | 2.8 V | Auto discharge | A (fixed)* | XDFN4 (Pb-Free) | 10000 / Tape & Reel |
| NCP4680DMX30TCG | 3.0 V | Auto discharge | A (fixed)* | XDFN4 (Pb-Free) | 10000 / Tape & Reel |
| NCP4680DMX33TCG | 3.3 V | Auto discharge | A (fixed)* | XDFN4 (Pb-Free) | 10000 / Tape & Reel |
| NCP4680DSQ08T1G | 0.8 V | Auto discharge | AF08 | SC-70 (Pb-Free) | 3000 / Tape & Reel |
| NCP4680DSQ09T1G | 0.9 V | Auto discharge | AF09 | SC-70 (Pb-Free) | 3000 / Tape & Reel |
| NCP4680DSQ12T1G | 1.2 V | Auto discharge | AF12 | SC-70 (Pb-Free) | 3000 / Tape & Reel |
| NCP4680DSQ15T1G | 1.5 V | Auto discharge | AF15 | SC-70 (Pb-Free) | 3000 / Tape & Reel |
| NCP4680DSQ18T1G | 1.8 V | Auto discharge | AF18 | SC-70 (Pb-Free) | 3000 / Tape & Reel |
| NCP4680DSQ25T1G | 2.5 V | Auto discharge | AF25 | SC-70 (Pb-Free) | 3000 / Tape & Reel |
| NCP4680DSQ28T1G | 2.8 V | Auto discharge | AF28 | SC-70 (Pb-Free) | 3000 / Tape & Reel |
| NCP4680DSQ30T1G | 3.0 V | Auto discharge | AF30 | SC-70 (Pb-Free) | 3000 / Tape & Reel |
| NCP4680DSQ33T1G | 3.3 V | Auto discharge | AF33 | SC-70 (Pb-Free) | 3000 / Tape & Reel |

[†]For information on tape and reel specifications, including part orientation and tape sizes, please refer to our Tape and Reel Packaging Specifications Brochure, BRD8011/D.

*Marking codes for XDFN0808 packages are unified.

**To order other package and voltage variants, please contact your ON Semiconductor sales representative.

NCP4680

PACKAGE DIMENSIONS

SC-88A (SC-70-5/SOT-353)
CASE 419A-02
ISSUE K

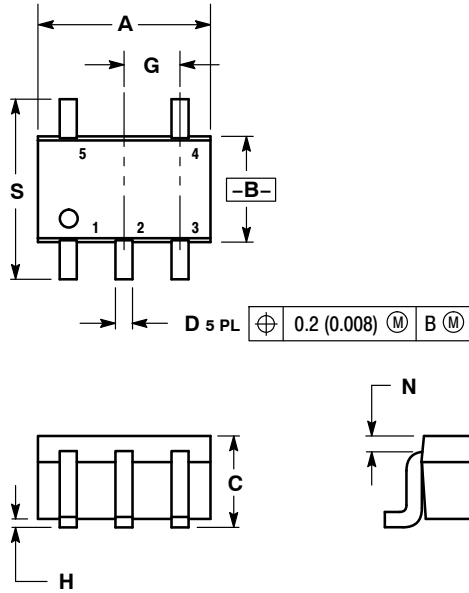

NOTES:

1. DIMENSIONING AND TOLERANCING PER ANSI Y14.5M, 1982.
2. CONTROLLING DIMENSION: INCH.
3. 419A-01 OBSOLETE. NEW STANDARD 419A-02.
4. DIMENSIONS A AND B DO NOT INCLUDE MOLD FLASH, PROTRUSIONS, OR GATE BURRS.

| DIM | INCHES | | MILLIMETERS | |
|-----|-----------|-------|-------------|------|
| | MIN | MAX | MIN | MAX |
| A | 0.071 | 0.087 | 1.80 | 2.20 |
| B | 0.045 | 0.053 | 1.15 | 1.35 |
| C | 0.031 | 0.043 | 0.80 | 1.10 |
| D | 0.004 | 0.012 | 0.10 | 0.30 |
| G | 0.026 BSC | | 0.65 BSC | |
| H | --- | 0.004 | --- | 0.10 |
| J | 0.004 | 0.010 | 0.10 | 0.25 |
| K | 0.004 | 0.012 | 0.10 | 0.30 |
| N | 0.008 REF | | 0.20 REF | |
| S | 0.079 | 0.087 | 2.00 | 2.20 |

NCP4680

PACKAGE DIMENSIONS

SOT-23 5-LEAD
CASE 1212-01
ISSUE A

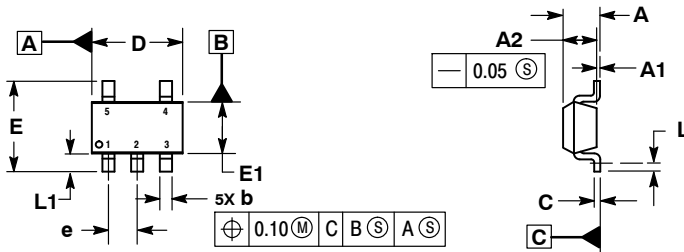

NOTES:

1. DIMENSIONING AND TOLERANCING PER ASME Y14.5M, 1994.
2. CONTROLLING DIMENSIONS: MILLIMETERS.
3. DATUM C IS THE SEATING PLANE.

| MILLIMETERS | | |
|-------------|----------|------|
| DIM | MIN | MAX |
| A | --- | 1.45 |
| A1 | 0.00 | 0.10 |
| A2 | 1.00 | 1.30 |
| b | 0.30 | 0.50 |
| c | 0.10 | 0.25 |
| D | 2.70 | 3.10 |
| E | 2.50 | 3.10 |
| E1 | 1.50 | 1.80 |
| e | 0.95 BSC | |
| L | 0.20 | --- |
| L1 | 0.45 | 0.75 |

RECOMMENDED SOLDERING FOOTPRINT*

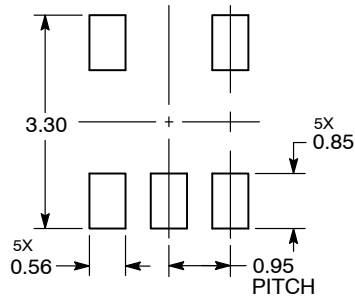

DIMENSIONS: MILLIMETERS

*For additional information on our Pb-Free strategy and soldering details, please download the ON Semiconductor Soldering and Mounting Techniques Reference Manual, SOLDERRM/D.

NCP4680

PACKAGE DIMENSIONS

XDFN4 0.8x0.8, 0.48P
CASE 711AB-01
ISSUE O

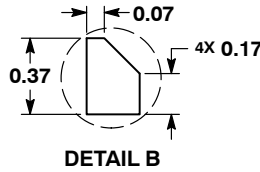
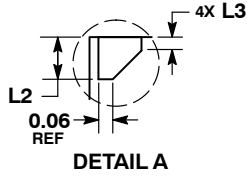
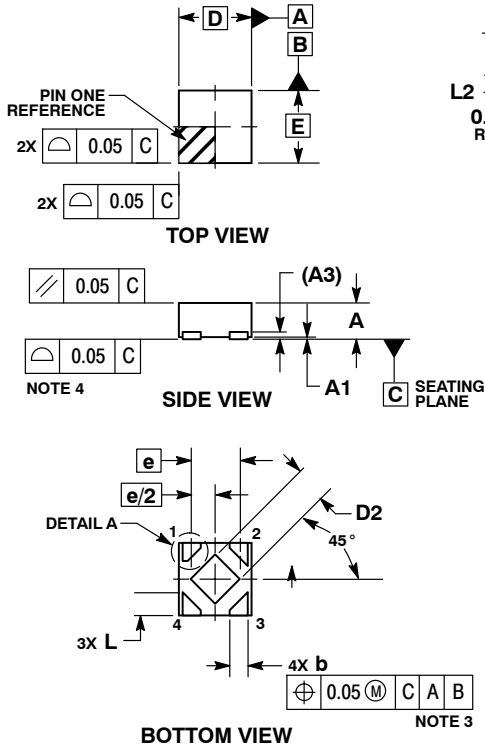

NOTES:

1. DIMENSIONING AND TOLERANCING PER ASME Y14.5M, 1994.
2. CONTROLLING DIMENSION: MILLIMETERS.
3. DIMENSION b APPLIES TO PLATED TERMINALS.
4. COPLANARITY APPLIES TO THE EXPOSED PAD AS WELL AS THE TERMINALS.

| MILLIMETERS | | |
|-------------|------|------|
| DIM | MIN | MAX |
| A | --- | 0.40 |
| A1 | 0.00 | 0.05 |
| A3 | 0.10 | REF |
| b | 0.17 | 0.27 |
| D | 0.80 | BSC |
| D2 | 0.20 | 0.30 |
| E | 0.80 | BSC |
| e | 0.48 | BSC |
| L | 0.23 | 0.33 |
| L2 | 0.17 | 0.27 |
| L3 | 0.01 | 0.11 |

RECOMMENDED MOUNTING FOOTPRINT*

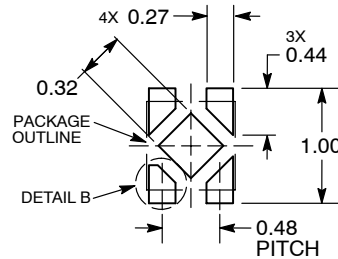

DIMENSIONS: MILLIMETERS

*For additional information on our Pb-Free strategy and soldering details, please download the ON Semiconductor Soldering and Mounting Techniques Reference Manual, SOLDERRM/D.

ON Semiconductor and are registered trademarks of Semiconductor Components Industries, LLC (SCILLC). SCILLC reserves the right to make changes without further notice to any products herein. SCILLC makes no warranty, representation or guarantee regarding the suitability of its products for any particular purpose, nor does SCILLC assume any liability arising out of the application or use of any product or circuit, and specifically disclaims any and all liability, including without limitation special, consequential or incidental damages. "Typical" parameters which may be provided in SCILLC data sheets and/or specifications can and do vary in different applications and actual performance may vary over time. All operating parameters, including "Typicals" must be validated for each customer application by customer's technical experts. SCILLC does not convey any license under its patent rights nor the rights of others. SCILLC products are not designed, intended, or authorized for use as components in systems intended for surgical implant into the body, or other applications intended to support or sustain life, or for any other application in which the failure of the SCILLC product could create a situation where personal injury or death may occur. Should Buyer purchase or use SCILLC products for any such unintended or unauthorized application, Buyer shall indemnify and hold SCILLC and its officers, employees, subsidiaries, affiliates, and distributors harmless against all claims, costs, damages, and expenses, and reasonable attorney fees arising out of, directly or indirectly, any claim of personal injury or death associated with such unintended or unauthorized use, even if such claim alleges that SCILLC was negligent regarding the design or manufacture of the part. SCILLC is an Equal Opportunity/Affirmative Action Employer. This literature is subject to all applicable copyright laws and is not for resale in any manner.

PUBLICATION ORDERING INFORMATION

LITERATURE FULFILLMENT:
Literature Distribution Center for ON Semiconductor
P.O. Box 5163, Denver, Colorado 80217 USA
Phone: 303-675-2175 or 800-344-3860 Toll Free USA/Canada
Fax: 303-675-2176 or 800-344-3867 Toll Free USA/Canada
Email: orderlit@onsemi.com

N. American Technical Support: 800-282-9855 Toll Free
USA/Canada
Europe, Middle East and Africa Technical Support:
Phone: 421 33 790 2910
Japan Customer Focus Center
Phone: 81-3-5773-3850

ON Semiconductor Website: www.onsemi.com
Order Literature: <http://www.onsemi.com/orderlit>
For additional information, please contact your local Sales Representative

NCP4680/D