

Technical Data Sheet

Side Face Silicon Phototransistor

PT2559B/L2-F

Features

- Fast response time
- High photo sensitivity
- Pb free
- This product itself will remain within RoHS compliant version.

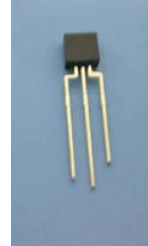

Descriptions

- PT2559B/L2-F is a high speed and high sensitive dual phototransistor molded in a black plastic package with plat side view.
- The device is spectrally matched with IR emitters.

Applications

- Mouse
- Optoelectronic Switch
- Photo Interrupter

Device Selection Guide

LED Part No.	Chip	Lens Color
	Material	
PT2559B/L2-F	Silicon	Black

Electro-Optical Characteristics (Ta=25°C)

Parameter	Symbol	Condition	Min	Typ	Max	Unit
Collector – Emitter Breakdown Voltage	BV_{CEO}	$I_C=100\ \mu A$ $E_e=0mW/cm^2$	30	---	---	V
Emitter-Collector Breakdown Voltage	BV_{ECO}	$I_E=100\ \mu A$ $E_e=0mW/cm^2$	5	---	---	V
Collector-Emitter Saturation Voltage	$V_{CE(sat)}$	$I_C=2mA$ $E_e=1mW/cm^2$	---	---	0.4	V
Rise Time	t_r	$V_{CE}=5V$ $I_C=1mA$ $R_L=1000\ \Omega$	---	15	---	μS
Fall Time	t_f		---	15	---	
Collector Dark Current	I_{CEO}	$E_e=0mW/cm^2$ $V_{CE}=20V$	---	---	100	nA
On State Collector Current	$I_{C(on)}$	$V_{CE}=5V,$ $E_e=0.555mW/cm^2$	129	---	1085	μA
Wavelength of Peak Sensitivity	λ_p	---	---	940	---	nm
Rang of Spectral Bandwidth	$\lambda_{0.5}$	---	760	---	1100	nm

Typical Electro-Optical Characteristics Curves

Fig.1 Power Dissipation vs. Ambient Temperature

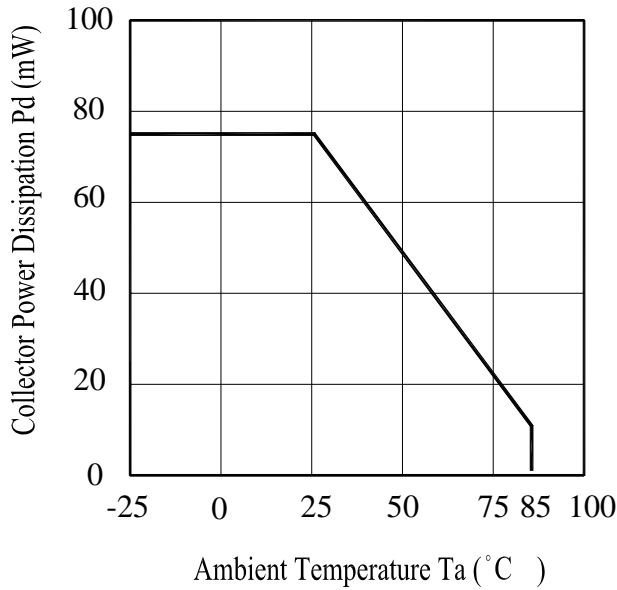

Fig.2 Spectral Sensitivity

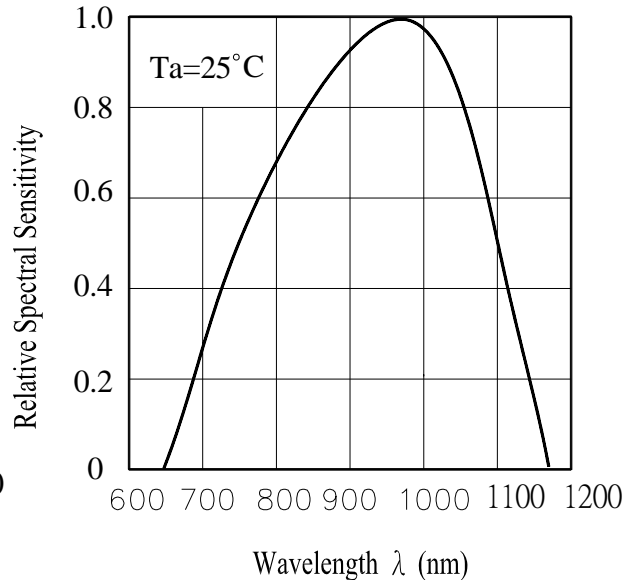

Fig.3 Dark Current vs. Ambient Temperature

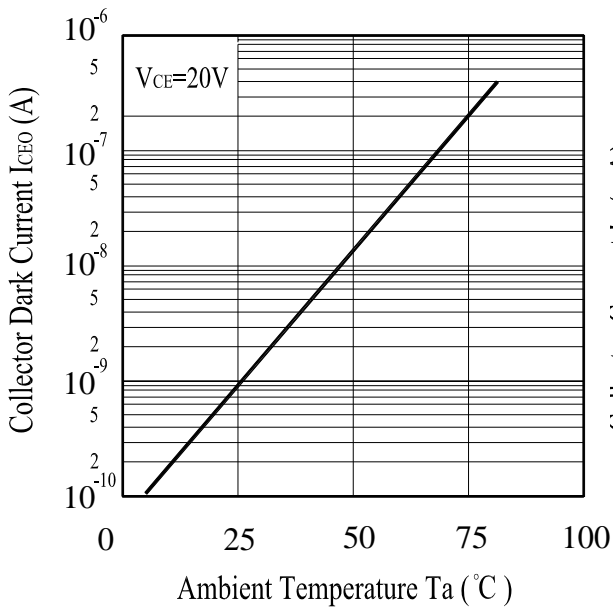
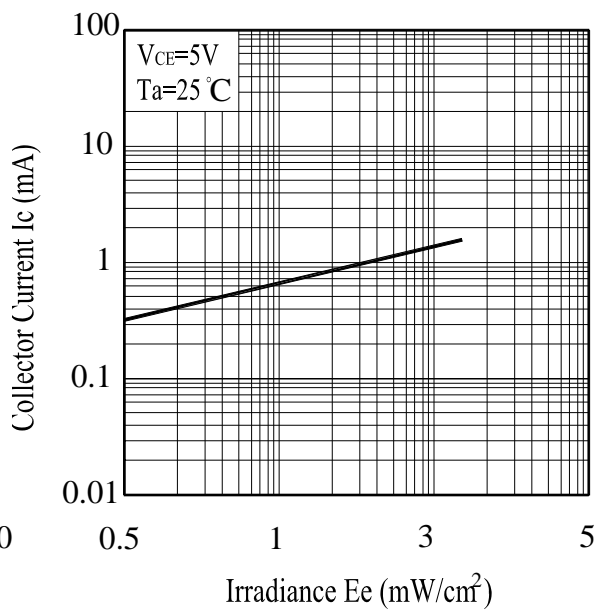

Fig. 4 Reverse Light Current vs. E_e



Typical Electro-Optical Characteristics Curves

Fig.5 Terminal Capacitance vs.
Reverse Voltage

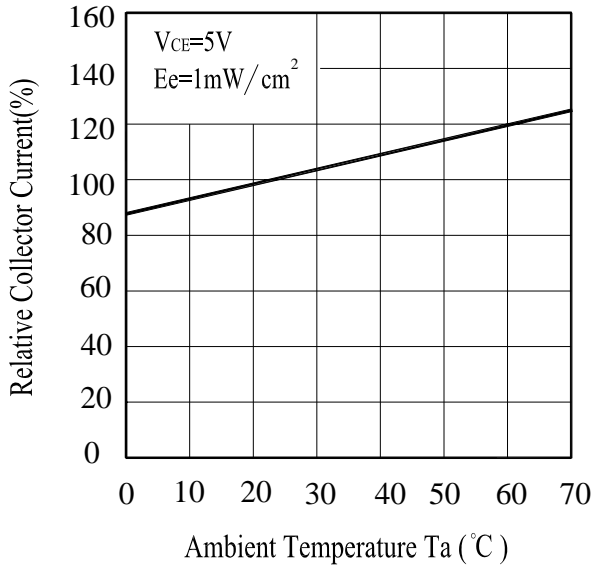
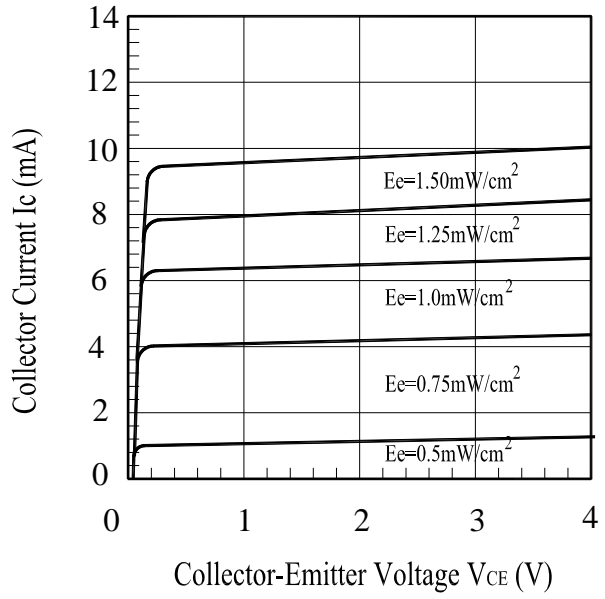

Fig.6 Response Time vs.
Load Resistance



Reliability Test Item And Condition

The reliability of products shall be satisfied with items listed below.

Confidence level : 90%

LTPD : 10%

NO.	Item	Test Conditions	Test Hours/ Cycles	Sample Sizes	Failure Judgement Criteria	Ac/Re
1	Solder Heat	TEMP. : 260°C	10secs	22pcs	$I_{C(ON)} \leq L \times 0.8$ L : the initial test value	0/1
2	Temperature Cycle	H : +100°C 15mins ↑ 5mins ↓ L : -40°C 15mins	300Cycles	22pcs		0/1
3	Thermal Shock	H : +100°C 5mins ↑ 10secs ↓ L : -10°C 5mins	300Cycles	22pcs		0/1
4	High Temperature Storage	TEMP. : +100°C	1000hrs	22pcs		0/1
5	Low Temperature Storage	TEMP. : -40°C	1000hrs	22pcs		0/1
6	DC Operating Life	$V_{CE}=5V$	1000hrs	22pcs		0/1
7	High Temperature/ High Humidity	85°C / 85% R.H	1000hrs	22pcs		0/1

■ **Test Method For On State Collector Current :**

Condition : $E_e=0.555\text{mW/cm}^2$, $V_{CE}=5\text{V}$

Test Item : Collector Current [$I_{C(ON)}$]

Unit : μA

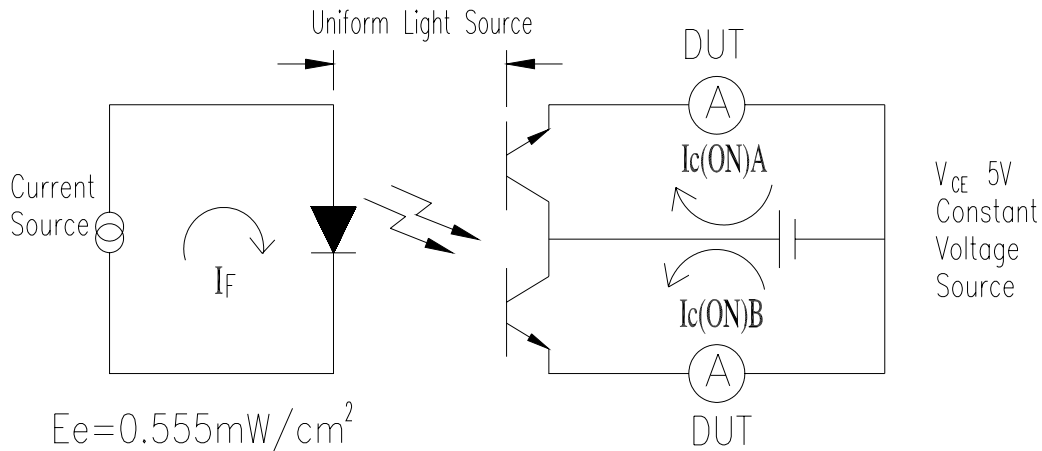

■ **To Distinguish Intensity:**

Condition: $V_{CE}=5\text{V}$ $E_e=0.555\text{mW/cm}^2$

A Ranks

Color Code	Ranks	Symbol	Min	Typ	Max	Unit	Test Condition
Red	A1	$I_{C(ON)}$	129	---	226	μA	$E_e=0.555\text{mW/cm}^2$ $V_{CE}=5\text{V}$
Blue	A2	$I_{C(ON)}$	195	---	306	μA	$E_e=0.555\text{mW/cm}^2$ $V_{CE}=5\text{V}$
Yellow	A3	$I_{C(ON)}$	262	---	380	μA	$E_e=0.555\text{mW/cm}^2$ $V_{CE}=5\text{V}$
Silver	A4	$I_{C(ON)}$	330	---	461	μA	$E_e=0.555\text{mW/cm}^2$ $V_{CE}=5\text{V}$
Green	A5	$I_{C(ON)}$	398	---	544	μA	$E_e=0.555\text{mW/cm}^2$ $V_{CE}=5\text{V}$
Purple	A6	$I_{C(ON)}$	468	---	625	μA	$E_e=0.555\text{mW/cm}^2$ $V_{CE}=5\text{V}$
White	A7	$I_{C(ON)}$	536	---	703	μA	$E_e=0.555\text{mW/cm}^2$ $V_{CE}=5\text{V}$
Brown	A8	$I_{C(ON)}$	604	---	785	μA	$E_e=0.555\text{mW/cm}^2$ $V_{CE}=5\text{V}$
Orange	A9	$I_{C(ON)}$	673	---	862	μA	$E_e=0.555\text{mW/cm}^2$ $V_{CE}=5\text{V}$
Golden	A10	$I_{C(ON)}$	742	---	944	μA	$E_e=0.555\text{mW/cm}^2$ $V_{CE}=5\text{V}$
Pink	A11	$I_{C(ON)}$	812	---	1018	μA	$E_e=0.555\text{mW/cm}^2$ $V_{CE}=5\text{V}$
Red,Blue	A12	$I_{C(ON)}$	882	---	1085	μA	$E_e=0.555\text{mW/cm}^2$ $V_{CE}=5\text{V}$

* $I_{C(ON)} = [I_{C(ON)A} + I_{C(ON)B}] / 2$



PT2559B/L2-F

Packing Quantity Specification

1. 1000Pcs/1Bag , 8Bags/1Box
2. 10Boxes/1Carton

EVERLIGHT

CPN:

P/N:



PT2559B/L2-F

QTY:



LOT NO:



CAT:

HUE:

REF:

Label Form Specification

CPN: Customer's Production Number

P/N : Production Number

QTY: Packing Quantity

CAT: Ranks

HUE: Peak Wavelength

REF: Reference

LOT No: Lot Number

Notes

1. Above specification may be changed without notice. EVERLIGHT will reserve authority on material change for above specification.
2. When using this product, please observe the absolute maximum ratings and the instructions for using outlined in these specification sheets. EVERLIGHT assumes no responsibility for any damage resulting from use of the product which does not comply with the absolute maximum ratings and the instructions included in these specification sheets.
3. These specification sheets include materials protected under copyright of EVERLIGHT corporation. Please don't reproduce or cause anyone to reproduce them without EVERLIGHT's consent.

EVERLIGHT ELECTRONICS CO., LTD.

Office: No 25, Lane 76, Sec 3, Chung Yang Rd,
Tucheng, Taipei 236, Taiwan, R.O.C

Tel: 886-2-2267-2000, 2267-9936

Fax: 886-2267-6244, 2267-6189, 2267-6306

<http://www.everlight.com>