

Technical Data Sheet

5mm Phototransistor T-1

PT333-3B

Features

- Fast response time
- High photo sensitivity
- Pb free
- This product itself will remain within RoHS compliant version.

Descriptions

- PT333-3B is a high speed and high sensitive NPN silicon NPN epitaxial planar phototransistor molded in a standard 5 mm package. Due to its black epoxy the device is sensitive to visible and near Infrared radiation.



Applications

- Infrared applied system
- Camera
- Cockroach catcher

Device Selection Guide

LED Part No.	Chip	Lens Color
	Material	
PT333-3B	Silicon	Black

Package Dimensions

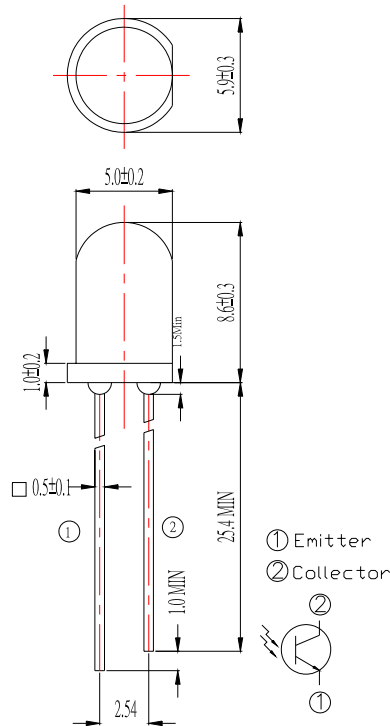

- Notes:** 1.All dimensions are in millimeters
- 2.Tolerances unless dimensions $\pm 0.25\text{mm}$

Absolute Maximum Ratings (Ta=25°C)

Parameter	Symbol	Rating	Units
Collector-Emitter Voltage	V_{CEO}	30	V
Emitter-Collector-Voltage	V_{ECO}	5	V
Collector Current	I_C	20	mA
Operating Temperature	T_{opr}	-25 ~ +85°C	°C
Storage Temperature	T_{stg}	-40 ~ +85°C	°C
Lead Soldering Temperature(*1)	T_{sol}	260	°C
Power Dissipation at (or below) 25°C Free Air Temperature	P_c	75	mW

Notes: *1:Soldering time ≤ 5 seconds.

Electro-Optical Characteristics (Ta=25°C)

Parameter	Symbol	Condition	Min.	Typ.	Max.	Units
Collector – Emitter Breakdown Voltage	BV_{CEO}	$I_C=100\ \mu A$ $E_e=0mW/cm^2$	30	---	---	V
Emitter-Collector Breakdown Voltage	BV_{ECO}	$I_E=100\ \mu A$ $E_e=0mW/cm^2$	5	---	---	V
Collector-Emitter Saturation Voltage	$V_{CE(sat)}$	$I_C=2mA$ $E_e=1mW/cm^2$	---	---	0.4	V
Rise Time	t_r	$V_{CE}=5V$ $I_C=1mA$ $RL=1000\ \Omega$	---	15	---	μS
Fall Time	t_f		---	15	---	
Collector Dark Current	I_{CEO}	$E_e=0mW/cm^2$ $V_{CE}=20V$	---	---	100	nA
On State Collector Current	$I_{C(on)}$	$E_e=1mW/cm^2$ $V_{CE}=5V$	0.7	3.0	---	mA
Wavelength of Peak Sensitivity	λ_p	---	---	940	---	nm
Rang of Spectral Bandwidth	$\lambda_{0.5}$	---	---	840-1100	---	nm

Rankings

Parameter	Symbol	Min	Max	Unit	Test Condition
G	$I_{C(ON)}$	0.70	1.90	mA	$V_{CE}=5V$ $E_e=1mW/cm^2$
H		1.14	2.60		
J		1.77	3.61		
K		2.67	5.07		
L		4.18	7.07		

Typical Electro-Optical Characteristics Curves

Fig.1 Collector Power Dissipation vs. Ambient Temperature

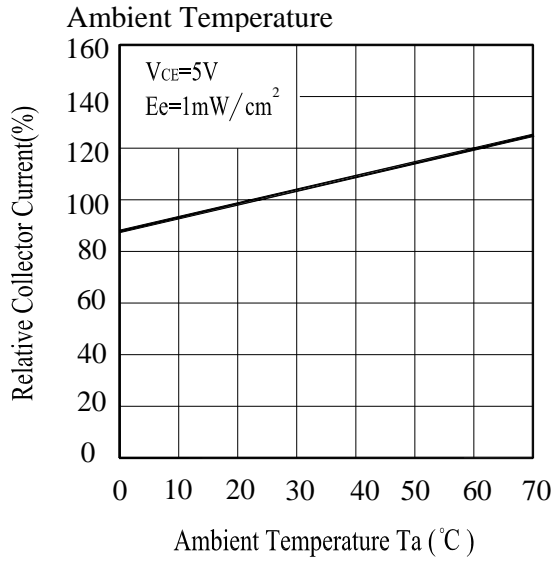

Fig.2 Spectral Sensitivity

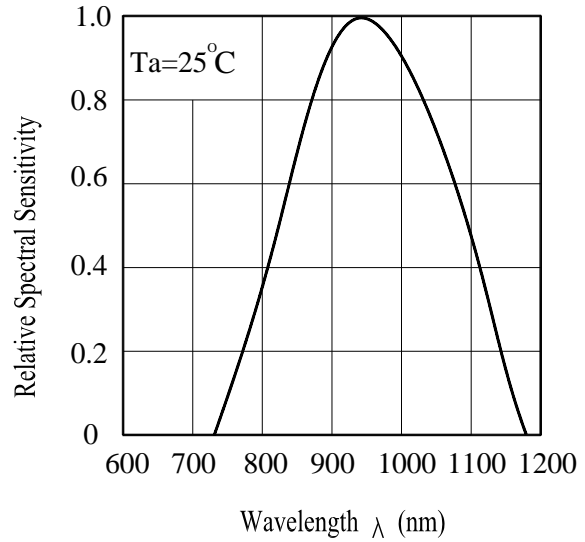

Fig.3 Relative Collector Current vs. Ambient Temperature

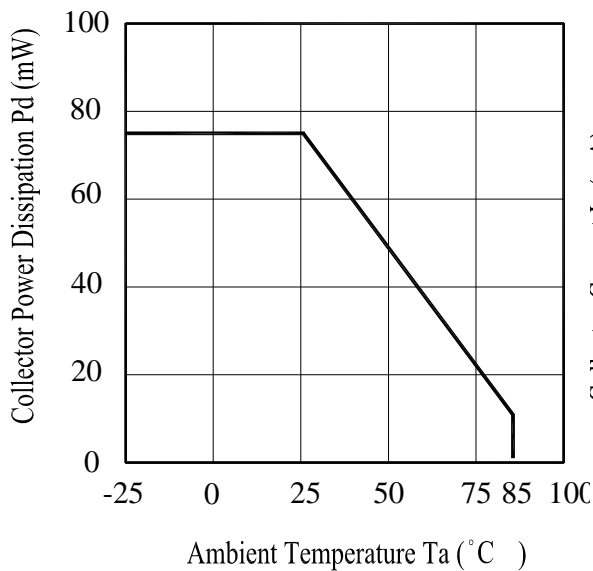
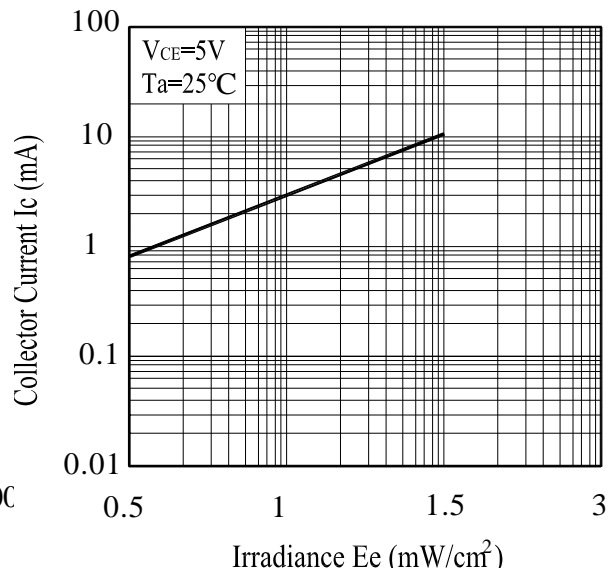

Fig.4 Collector Current vs. Irradiance



Typical Electro-Optical Characteristics Curves

Fig.5 Collector Dark Current vs.

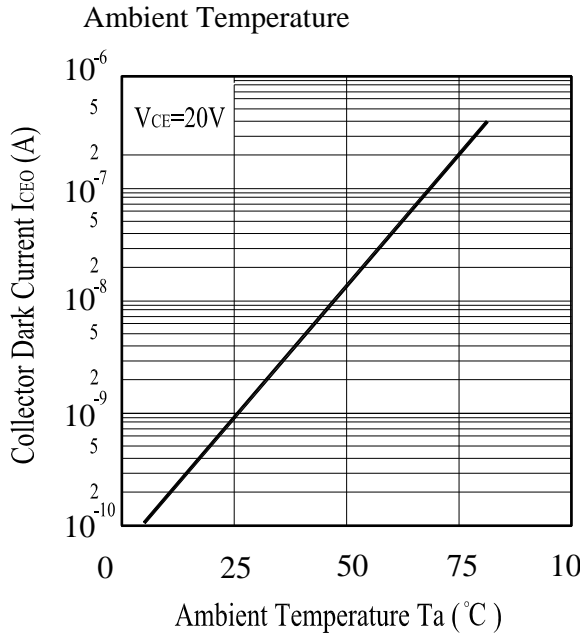
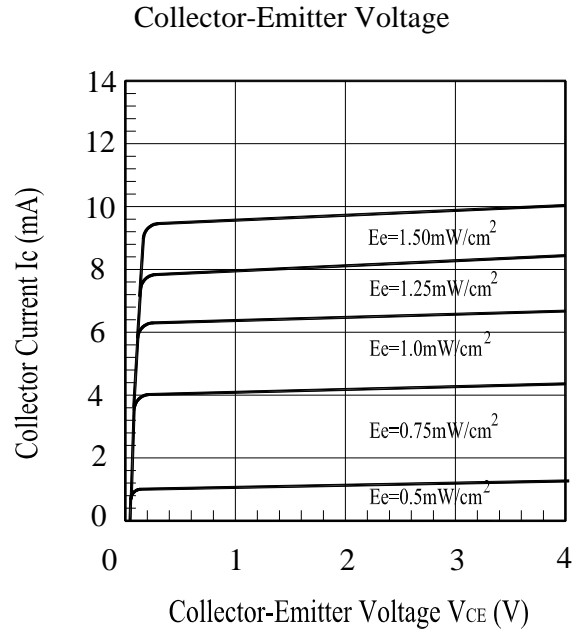

Fig.6 Collector Current vs.



Reliability Test Item And Condition

The reliability of products shall be satisfied with items listed below.

Confidence level : 90%

LTPD : 10%

NO.	Item	Test Conditions	Test Hours/ Cycles	Sample Sizes	Failure Judgement Criteria	Ac/Re
1	Solder Heat	TEMP. : 260°C±5°C	10secs	22pcs	$I_{C(ON)} \leq L \times 0.8$ L : the initial test value	0/1
2	Temperature Cycle	H : +100°C 15mins ↑ 5mins ↓ L : -40°C 15mins	300Cycles	22pcs		0/1
3	Thermal Shock	H : +100°C 5mins ↑ 10secs ↓ L : -10°C 5mins	300Cycles	22pcs		0/1
4	High Temperature Storage	TEMP. : +100°C	1000hrs	22pcs		0/1
5	Low Temperature Storage	TEMP. : -40°C	1000hrs	22pcs		0/1
6	DC Operating Life	$V_{CE}=5V$	1000hrs	22pcs		0/1
7	High Temperature/ High Humidity	85°C / 85% R.H	1000hrs	22pcs		0/1

Packing Quantity Specification

1.500PCS/1Bag , 5Bags/1Box
2.10Boxes/1Carton

Label Form Specification



CPN:

P/N:



PT333-3B

QTY:



LOT NO:



CAT:

HUE:

REF:

CPN: Customer's Production Number

P/N : Production Number

QTY: Packing Quantity

CAT: Ranks

HUE: Peak Wavelength

REF: Reference

LOT No: Lot Number

Notes

1. Above specification may be changed without notice. EVERLIGHT will reserve authority on material change for above specification.
2. When using this product, please observe the absolute maximum ratings and the instructions for using outlined in these specification sheets. EVERLIGHT assumes no responsibility for any damage resulting from use of the product which does not comply with the absolute maximum ratings and the instructions included in these specification sheets.
3. These specification sheets include materials protected under copyright of EVERLIGHT corporation. Please don't reproduce or cause anyone to reproduce them without EVERLIGHT's consent.

EVERLIGHT ELECTRONICS CO., LTD.

Office: No 25, Lane 76, Sec 3, Chung Yang Rd,
Tucheng, Taipei 236, Taiwan, R.O.C

Tel: 886-2-2267-2000, 2267-9936

Fax: 886-2267-6244, 2267-6189, 2267-6306

<http://www.everlight.com>