

## Matched N-Channel Pairs

<b>PRODUCT SUMMARY</b>					
Part Number	$V_{GS(off)}$ (V)	$V_{(BR)GSS}$ Min (V)	$g_{fs}$ Min (mS)	$I_G$ Typ (pA)	$ V_{GS1} - V_{GS2} $ Typ (mV)
U430	-1 to -4	-25	10	-15	25
U431	-2 to -6	-25	10	-15	25

### FEATURES

- Two-Chip Design
- High Slew Rate
- Low Offset/Drift Voltage
- Low Gate Leakage: 15 pA
- Low Noise
- High CMRR: 75 dB

### BENEFITS

- Tight Differential Match vs. Current
- Improved Op Amp Speed, Settling Time Accuracy
- Minimum Input Error/Trimming Requirement
- Insignificant Signal Loss/Error Voltage
- High System Sensitivity
- Minimum Error with Large Input Signals

### APPLICATIONS

- Wideband Differential Amps
- High-Speed, Temp-Compensated, Single-Ended Input Amps
- High-Speed Comparators
- Impedance Converters

### DESCRIPTION

The U430/431 are matched JFET pairs assembled in a TO-78 package. These devices offer good power gain even at frequencies beyond 250 MHz.

The TO-78 package is available with full military processing (see Military Information).

For similar products, see the low-noise U/SST401 series, the high-gain 2N5911/5912, and the low-leakage U421/423 data sheets.

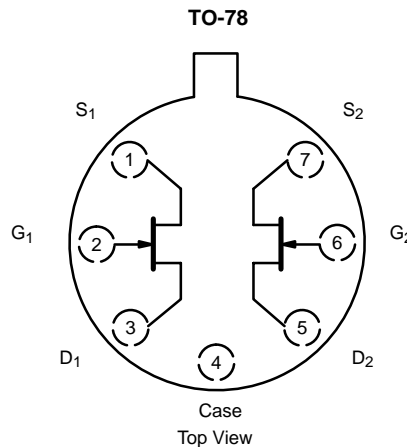

### ABSOLUTE MAXIMUM RATINGS

Gate-Drain, Gate-Source Voltage ..... -25 V  
 Gate Current ..... 10 mA  
 Lead Temperature ( $1/16$ " from case for 10 sec.) ..... 300 °C  
 Storage Temperature ..... -65 to 200 °C  
 Operating Junction Temperature ..... -55 to 150 °C

Power Dissipation : Per Side<sup>a</sup> ..... 300 mW  
 Total<sup>b</sup> ..... 500 mW

Notes  
 a. Derate 2.4 mW/°C above 25 °C  
 b. Derate 4 mW/°C above 25 °C

SPECIFICATIONS (T <sub>A</sub> = 25 °C UNLESS OTHERWISE NOTED)								
Parameter	Symbol	Test Conditions	Typ <sup>b</sup>	Limits				Unit
				U430		U431		
				Min	Max	Min	Max	
<b>Static</b>								
Gate-Source Breakdown Voltage	V <sub>(BR)GSS</sub>	I <sub>G</sub> = -1 μA, V <sub>DS</sub> = 0 V	-35	-25		-25		V
Gate-Source Cutoff Voltage	V <sub>GS(off)</sub>	V <sub>DS</sub> = 10 V, I <sub>D</sub> = 1 nA		-1	-4	-2	-6	
Saturation Drain Current <sup>d</sup>	I <sub>DSS</sub>	V <sub>DS</sub> = 10 V, V <sub>GS</sub> = 0 V		12	30	24	60	mA
Gate Reverse Current	I <sub>GSS</sub>	V <sub>GS</sub> = -15 V, V <sub>DS</sub> = 0 V			-150		-150	pA
			T <sub>A</sub> = 150 °C	-10		-150		-150
Gate Operating Current	I <sub>G</sub>	V <sub>DG</sub> = 10 V, I <sub>D</sub> = 5 mA						pA
			T <sub>A</sub> = 150 °C	-10				
Gate-Source Forward Voltage	V <sub>GS(F)</sub>	I <sub>G</sub> = 10 mA, V <sub>DS</sub> = 0 V	0.8		1		1	V
<b>Dynamic</b>								
Common-Source Forward Transconductance <sup>b</sup>	g <sub>fs</sub>	V <sub>DS</sub> = 10 V, I <sub>D</sub> = 10 mA, f = 1 kHz	15	10		10		mS
Common-Source Output Conductance <sup>b</sup>	g <sub>os</sub>		100		250		250	μS
Common-Source Input Capacitance	C <sub>iss</sub>	V <sub>GS</sub> = -10 V, V <sub>DS</sub> = 0 V, f = 1 MHz	4.5		5		5	pF
Common-Source Reverse Transfer Capacitance	C <sub>rss</sub>		2		2.5		2.5	
Equivalent Input Noise Voltage	$\bar{e}_n$	V <sub>DS</sub> = 10 V, I <sub>D</sub> = 10 mA f = 100 Hz	6					nV/ √Hz
<b>High Frequency</b>								
Common-Source Forward Transconductance	g <sub>fs</sub>	V <sub>DS</sub> = 10 V, I <sub>D</sub> = 10 mA f = 100 MHz	14					mS
Common-Source Output Conductance	g <sub>os</sub>		0.13					
Power-Match Source Admittance	g <sub>ig</sub>		12					
<b>Matching</b>								
Differential Gate-Source Voltage	V <sub>GS1</sub> - V <sub>GS2</sub>	V <sub>DG</sub> = 10 V, I <sub>D</sub> = 10 mA	25					mV
Saturation Drain Current Ratio <sup>c</sup>	$\frac{I_{DSS1}}{I_{DSS2}}$	V <sub>DS</sub> = 10 V, V <sub>GS</sub> = 0 V	0.95	0.9	1	0.9	1	
Transconductance Ratio <sup>c</sup>	$\frac{g_{fs1}}{g_{fs2}}$	V <sub>DS</sub> = 10 V, I <sub>D</sub> = 10 mA, f = 1 kHz	0.95	0.9	1	0.9	1	
Gate-Source Cutoff Voltage Ratio <sup>c</sup>	$\frac{V_{GS(off)1}}{V_{GS(off)2}}$	V <sub>DS</sub> = 10 V, I <sub>D</sub> = 1 nA	0.95	0.9	1	0.9	1	
Differential Gate Current	I <sub>G1</sub> - I <sub>G2</sub>	V <sub>DG</sub> = 10 V, I <sub>D</sub> = 5 mA	-2					pA
Common Mode Rejection Ratio	CMRR	V <sub>DG</sub> = 5 to 10 V, I <sub>D</sub> = 10 mA	75					dB

## Notes

- a. Typical values are for DESIGN AID ONLY, not guaranteed nor subject to production testing.  
 b. Pulse test: PW ≤ 300 μs duty cycle ≤ 3%.  
 c. Assumes smaller value in the numerator.

NZBD

**TYPICAL CHARACTERISTICS ( $T_A = 25^\circ\text{C}$  UNLESS OTHERWISE NOTED)**

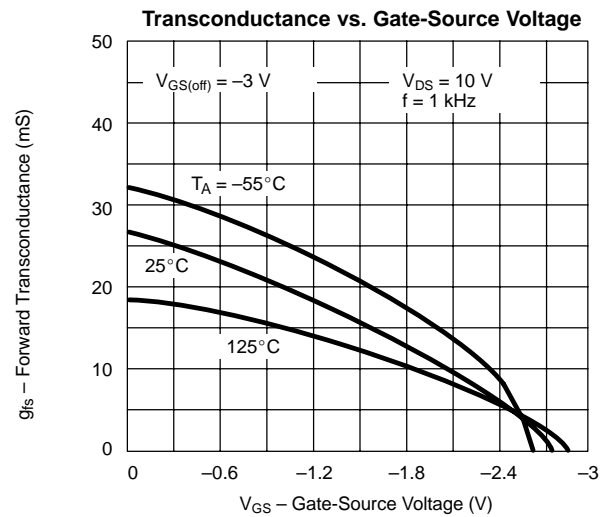
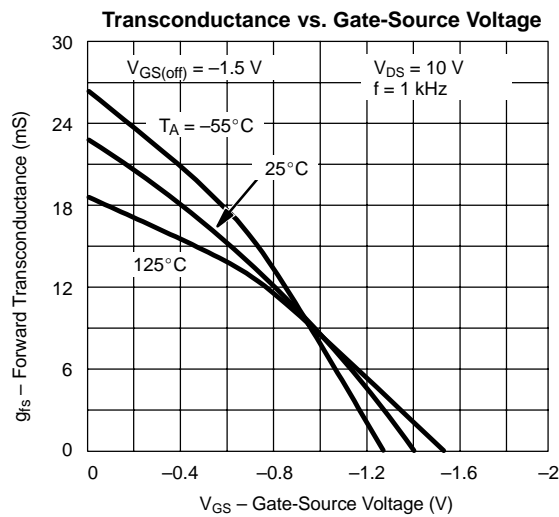
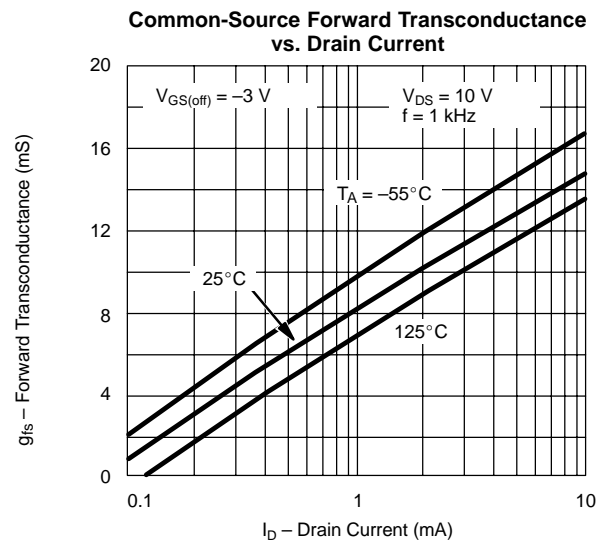
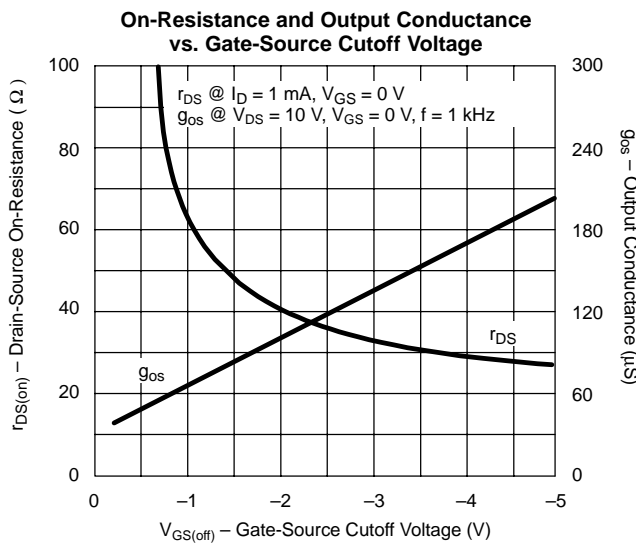
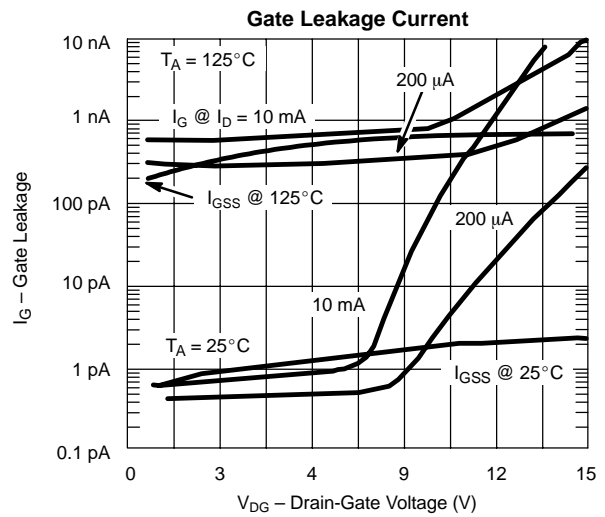
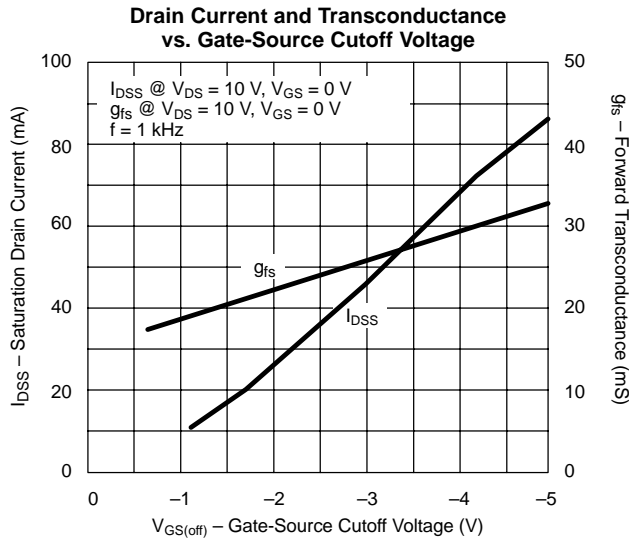



**TYPICAL CHARACTERISTICS ( $T_A = 25^\circ\text{C}$  UNLESS OTHERWISE NOTED)**

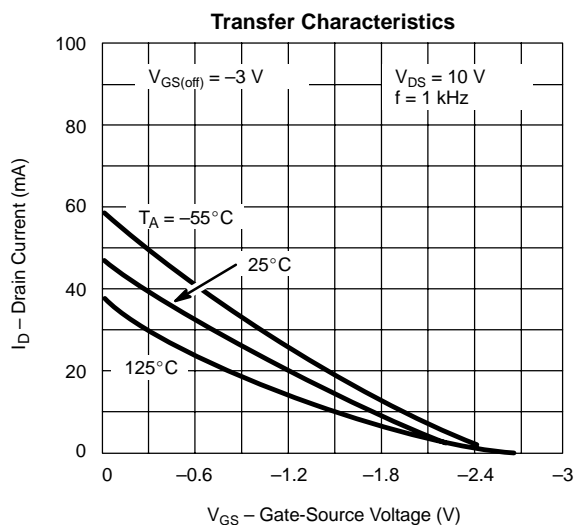
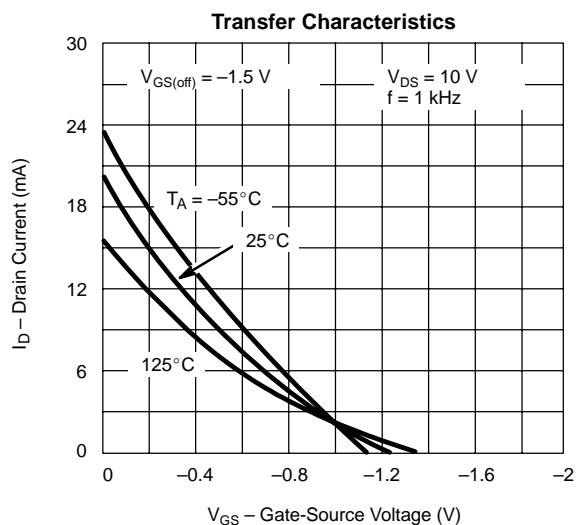
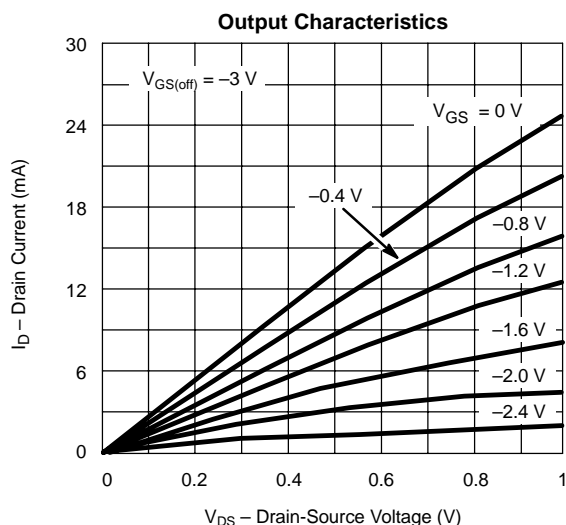
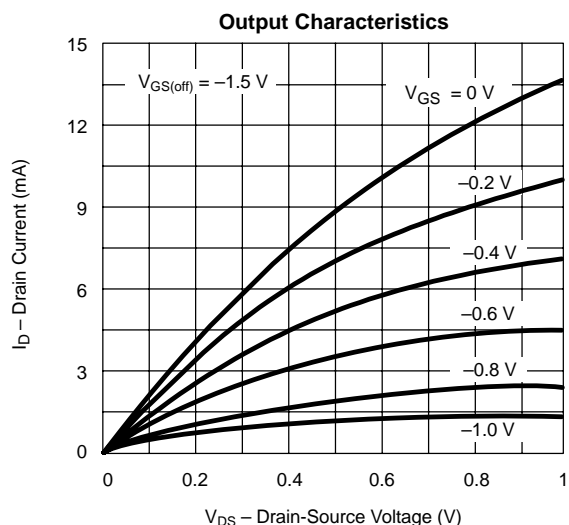
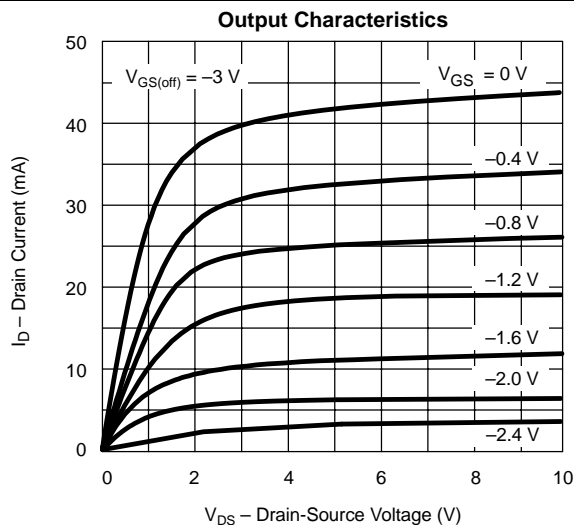
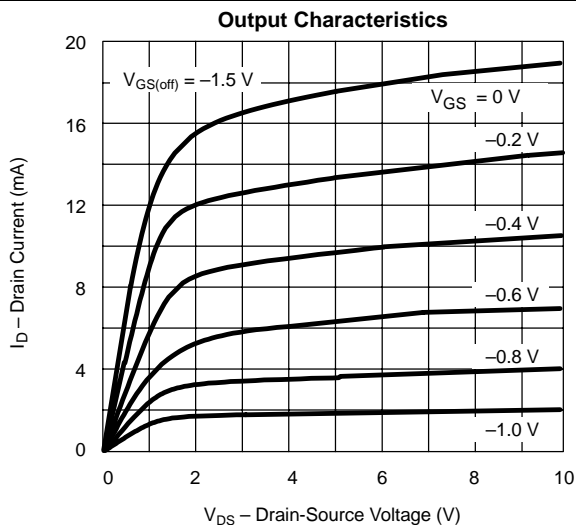

**TYPICAL CHARACTERISTICS (T<sub>A</sub> = 25°C UNLESS OTHERWISE NOTED)**

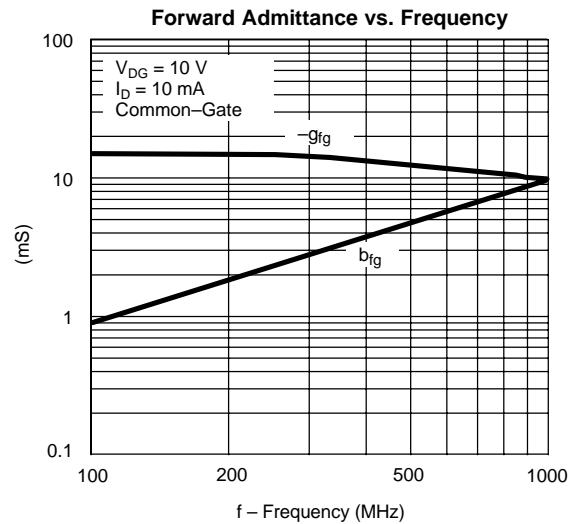
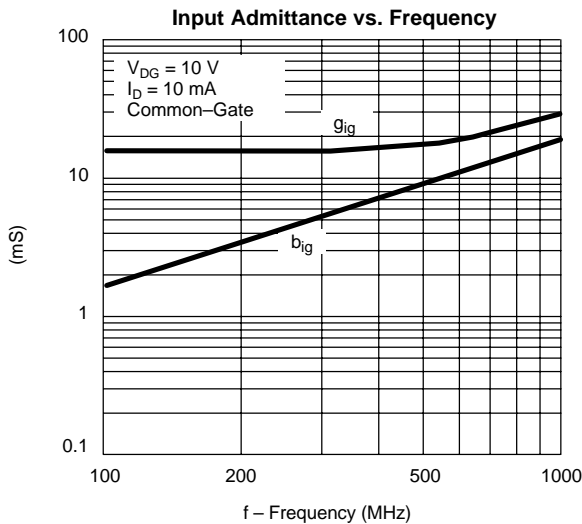
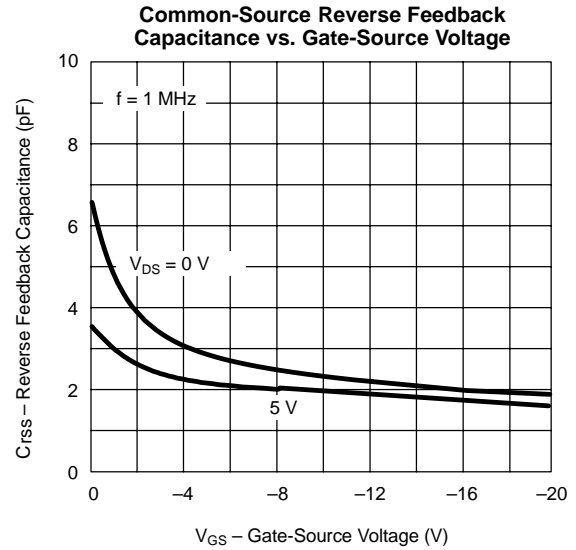
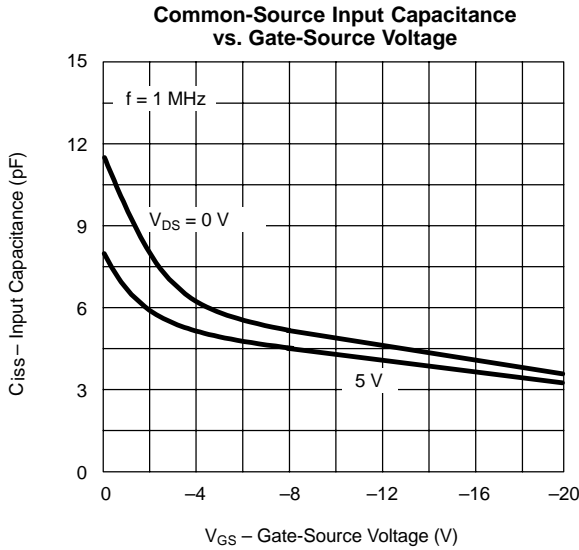
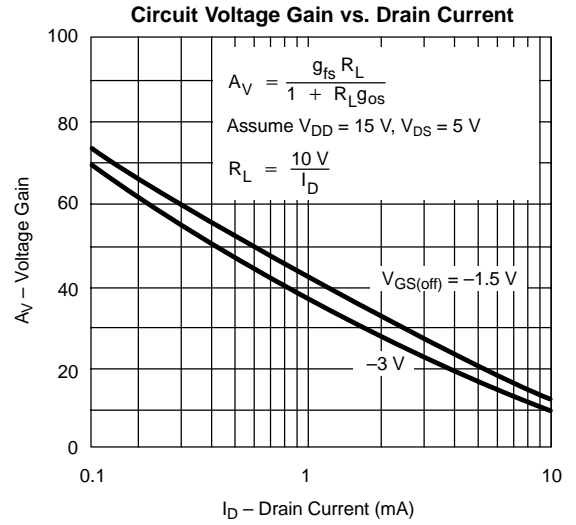
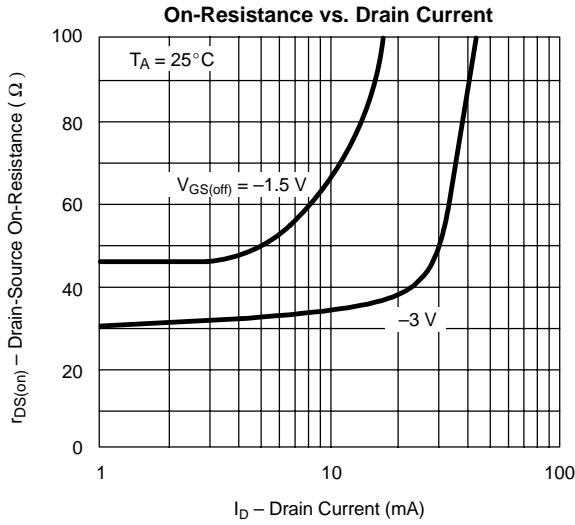

**TYPICAL CHARACTERISTICS ( $T_A = 25^\circ\text{C}$  UNLESS OTHERWISE NOTED)**

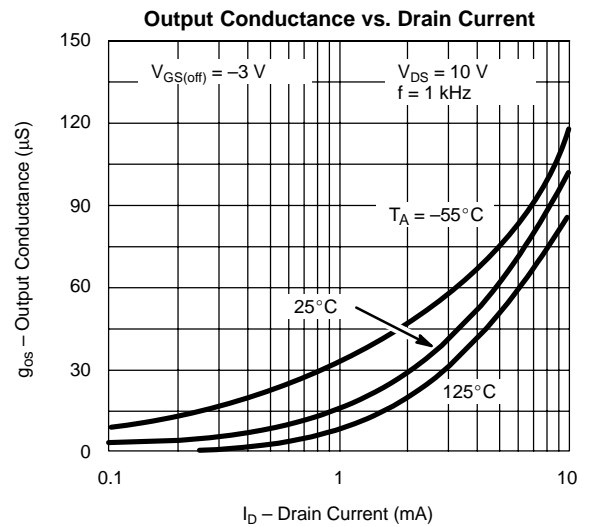
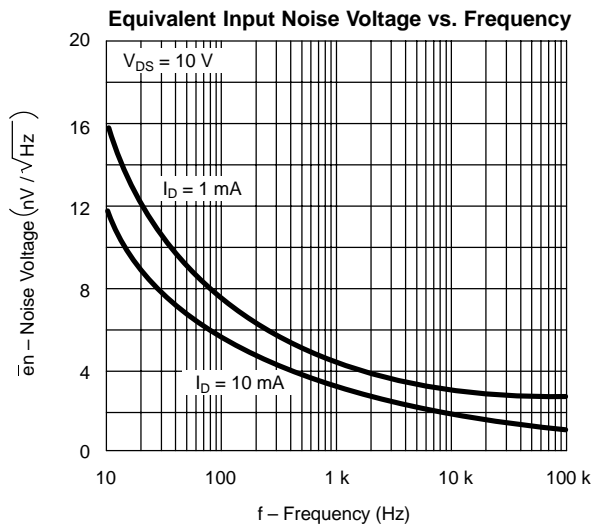
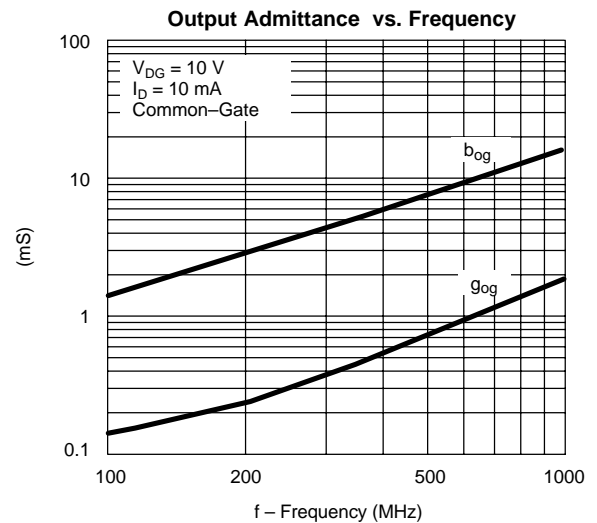
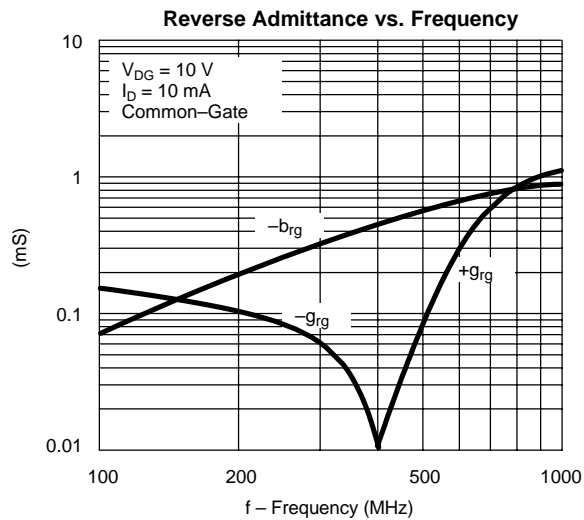



## Disclaimer

All product specifications and data are subject to change without notice.

Vishay Intertechnology, Inc., its affiliates, agents, and employees, and all persons acting on its or their behalf (collectively, "Vishay"), disclaim any and all liability for any errors, inaccuracies or incompleteness contained herein or in any other disclosure relating to any product.

Vishay disclaims any and all liability arising out of the use or application of any product described herein or of any information provided herein to the maximum extent permitted by law. The product specifications do not expand or otherwise modify Vishay's terms and conditions of purchase, including but not limited to the warranty expressed therein, which apply to these products.

No license, express or implied, by estoppel or otherwise, to any intellectual property rights is granted by this document or by any conduct of Vishay.

The products shown herein are not designed for use in medical, life-saving, or life-sustaining applications unless otherwise expressly indicated. Customers using or selling Vishay products not expressly indicated for use in such applications do so entirely at their own risk and agree to fully indemnify Vishay for any damages arising or resulting from such use or sale. Please contact authorized Vishay personnel to obtain written terms and conditions regarding products designed for such applications.

Product names and markings noted herein may be trademarks of their respective owners.