

P-Channel JFETs

PRODUCT SUMMARY				
Part Number	$V_{GS(off)}$ (V)	$r_{DS(on)}$ Max (Ω)	$I_{D(off)}$ Typ (pA)	t_{ON} Max (ns)
2N5114	5 to 10	75	-10	16
2N5115	3 to 6	100	-10	30
2N5116	1 to 4	150	-10	42

FEATURES

- Low On-Resistance: 2N5114 <75 Ω
- Fast Switching— t_{ON} : 16 ns
- High Off-Isolation— $I_{D(off)}$: -10 pA
- Low Capacitance: 6 pF
- Low Insertion Loss

BENEFITS

- Low Error Voltage
- High-Speed Analog Circuit Performance
- Negligible “Off-Error,” Excellent Accuracy
- Good Frequency Response
- Eliminates Additional Buffering

APPLICATIONS

- Analog Switches
- Choppers
- Sample-and-Hold
- Normally “On” Switches
- Current Limiters

DESCRIPTION

The 2N5114 series consists of p-channel JFET analog switches designed to provide low on-resistance, good off-isolation, and fast switching. These JFETs are optimized for use in complementary switching applications with the Vishay Siliconix 2N4856A series.

The 2N5114 series is available with JAN, JANTX, or JANTXV level processing, (see 2N5114 JAN series data sheet).

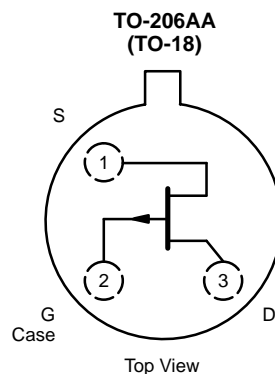

ABSOLUTE MAXIMUM RATINGS

Gate-Drain Voltage	30 V
Gate-Source Voltage	30 V
Gate Current	-50 mA
Storage Temperature	-65 to 200°C
Operating Junction Temperature	-55 to 200°C

Lead Temperature ($1/16$ " from case for 10 sec.)	300°C
Power Dissipation ^a	500 mW

Notes
a. Derate 3 mW/°C above 25°C

For applications information see AN104.



SPECIFICATIONS (T _A = 25 °C UNLESS OTHERWISE NOTED)										
Parameter	Symbol	Test Conditions	Typ ^a	Limits						Unit
				2N5114		2N5115		2N5116		
				Min	Max	Min	Max	Min	Max	
Static										
Gate-Source Breakdown Voltage	V _{(BR)GSS}	I _G = 1 μA, V _{DS} = 0 V	45	30		30		30		V
Gate-Source Cutoff Voltage	V _{GS(off)}	V _{DS} = -15 V, I _D = -1 nA		5	10	3	6	1	4	
Saturation Drain Current ^b	I _{DSS}	V _{GS} = 0 V	V _{DS} = -18 V	-30	-90					mA
			V _{DS} = -15 V			-15	-60	-5	-25	
Gate Reverse Current	I _{GSS}	V _{GS} = 20 V, V _{DS} = 0 V T _A = 150 °C		5	500		500		500	pA
				0.01	1		1		1	μA
Gate Operating Current ^c	I _G	V _{DG} = -15 V, I _D = -1 mA	-5							
Drain Cutoff Current	I _{D(off)}	V _{DS} = -15 V	V _{GS} = 12 V	-10	-500					pA
			V _{GS} = 7 V	-10			-500			
			V _{GS} = 5 V	-10				-500		
		V _{DS} = -15 V T _A = 150 °C	V _{GS} = 12 V	-0.02	-1					μA
			V _{GS} = 7 V	-0.02			-1			
			V _{GS} = 5 V	-0.02				-1		
Drain-Source On-Voltage	V _{DS(on)}	V _{GS} = 0 V	I _D = -15 mA	-1.0	-1.3					V
			I _D = -7 mA	-0.7			-0.8			
			I _D = -3 mA	-0.5				-0.6		
Drain-Source On-Resistance	r _{DS(on)}	V _{GS} = 0 V, I _D = -1 mA			75		100		150	Ω
Gate-Source Forward Voltage	V _{GS(F)}	I _G = -1 mA, V _{DS} = 0 V	-0.7	-1			-1		-1	V
Dynamic										
Common-Source Forward Transconductance ^c	g _{fs}	V _{DS} = -15 V, I _D = -1 mA f = 1 kHz	4.5							mS
Common-Source Output Conductance ^c	g _{os}		20							μS
Drain-Source On-Resistance	r _{ds(on)}	V _{GS} = 0 V, I _D = 0 mA, f = 1 kHz			75		100		150	Ω
Common-Source Input Capacitance	C _{iss}	V _{DS} = -15 V, V _{GS} = 0 V f = 1 MHz	20		25		25		25	pF
Common-Source Reverse Transfer Capacitance	C _{rss}	V _{DS} = 0 V f = 1 MHz	V _{GS} = 12 V	5	7					
			V _{GS} = 7 V	6			7			
			V _{GS} = 5 V	6				7		
Equivalent Input Noise Voltage ^c	e _n	V _{DS} = 10 V, I _D = 10 mA f = 1 kHz	20							nV/ √Hz
Switching										
Turn-On Time	t _{d(on)}	See Switching Circuit			6		10		12	ns
	t _r				10		20		30	
Turn-Off Time	t _{d(off)}				6		8		10	
	t _f				15		30		50	

Notes

- a. Typical values are for DESIGN AID ONLY, not guaranteed nor subject to production testing.
- b. Pulse test: PW ≤ 300 μs duty cycle ≤ 3%.
- c. This parameter not registered with JEDEC.

PSCIA

TYPICAL CHARACTERISTICS (T_A = 25 °C UNLESS OTHERWISE NOTED)

On-Resistance and Drain Current vs. Gate-Source Cutoff Voltage

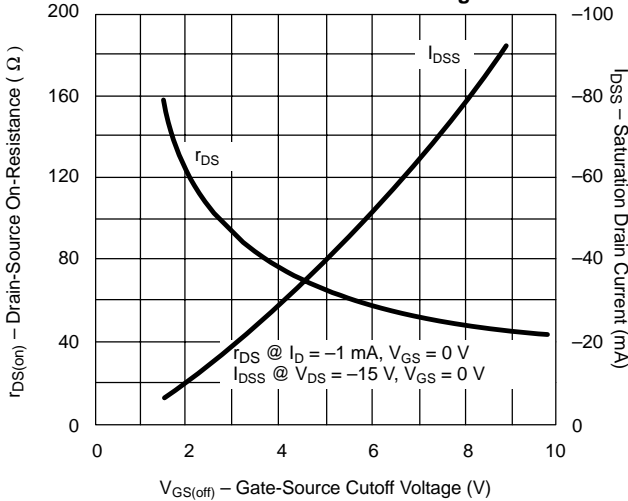

Forward Transconductance and Output Conductance vs. Gate-Source Cutoff Voltage

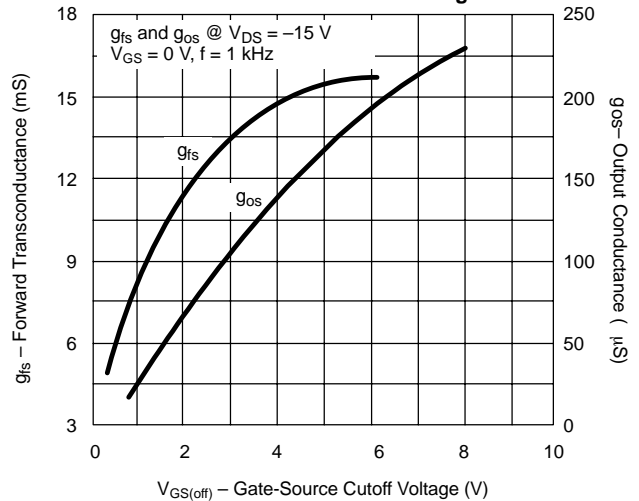

On-Resistance vs. Drain Current

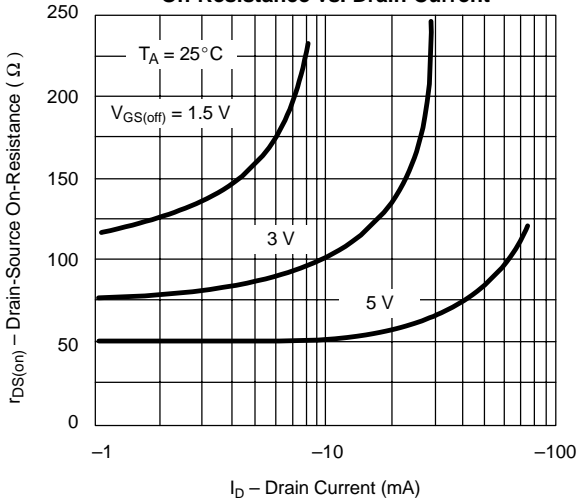

On-Resistance vs. Temperature

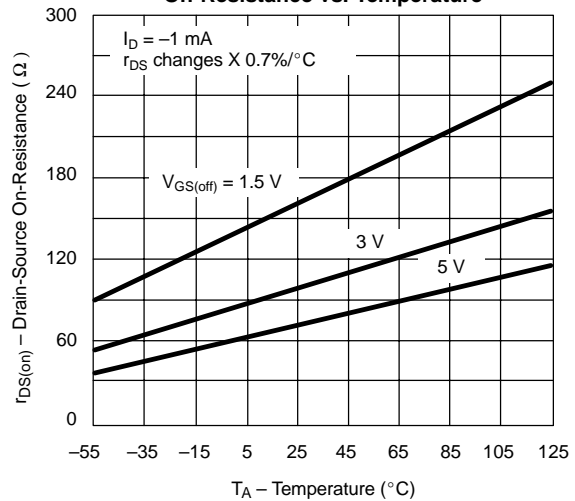

Turn-On Switching

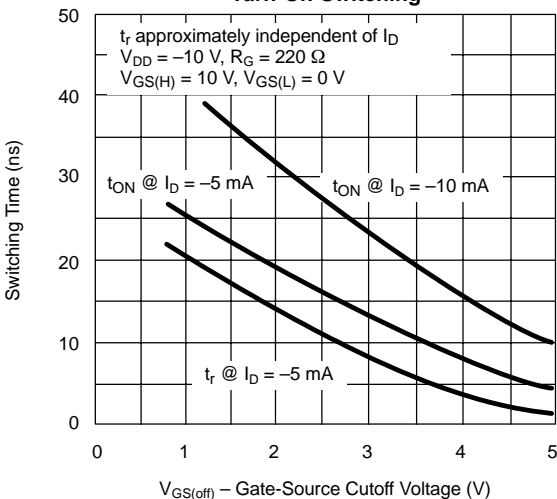

Turn-Off Switching

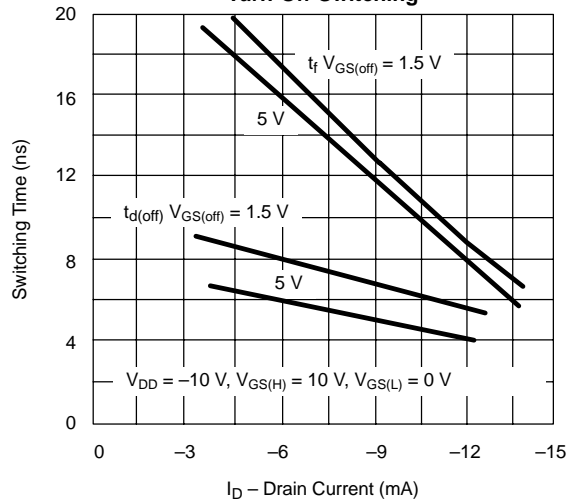

TYPICAL CHARACTERISTICS ($T_A = 25^\circ\text{C}$ UNLESS OTHERWISE NOTED)

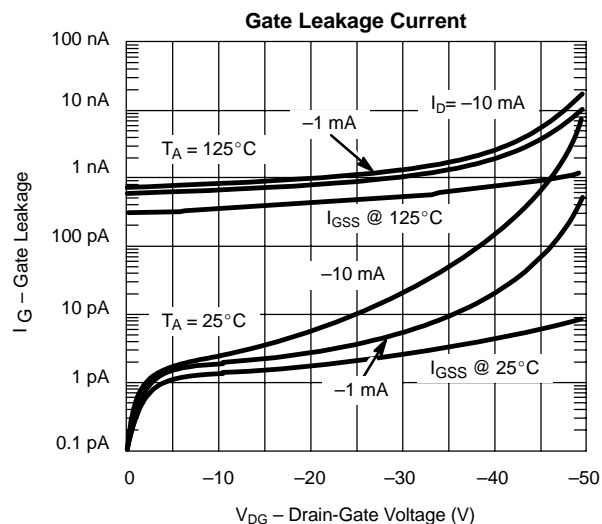
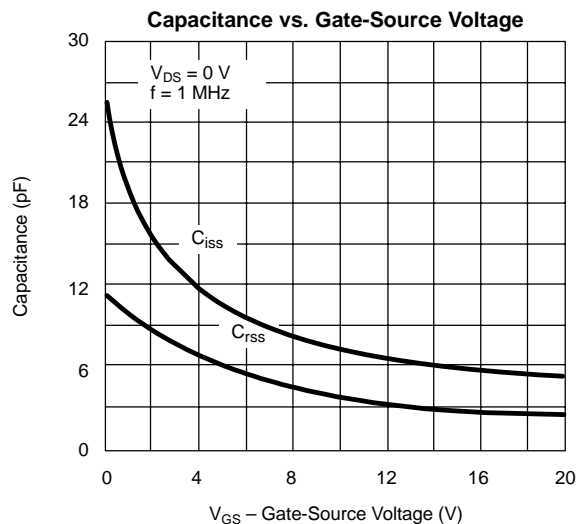
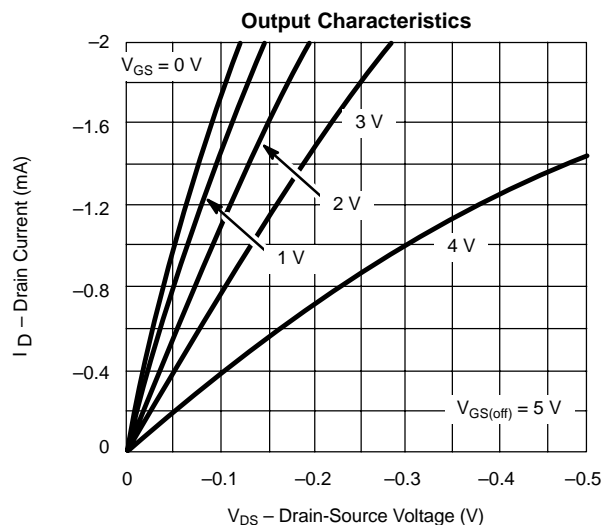
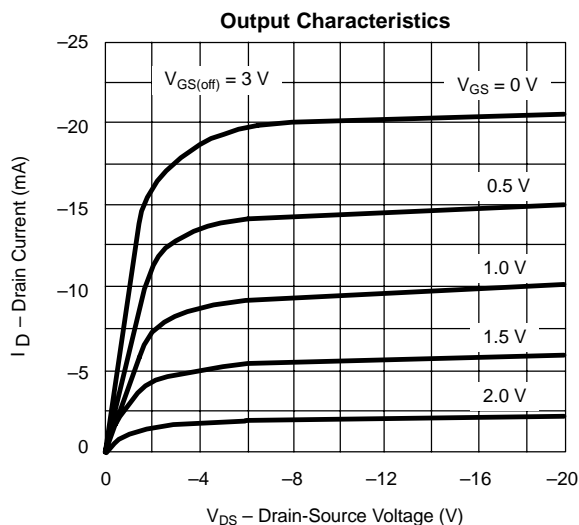
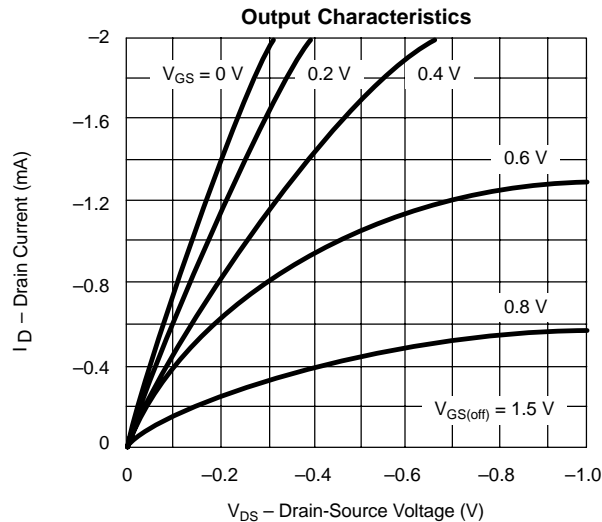
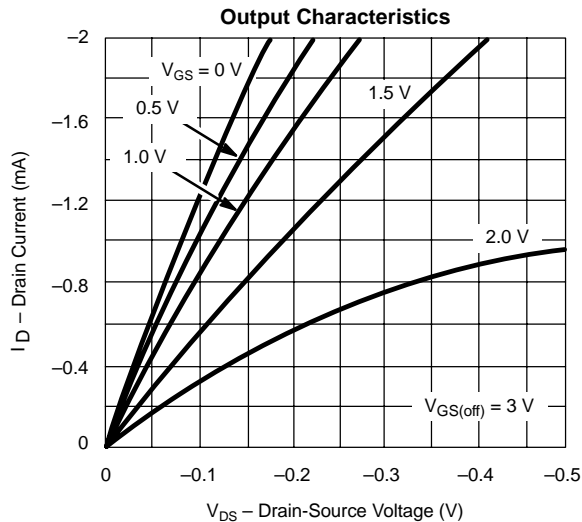

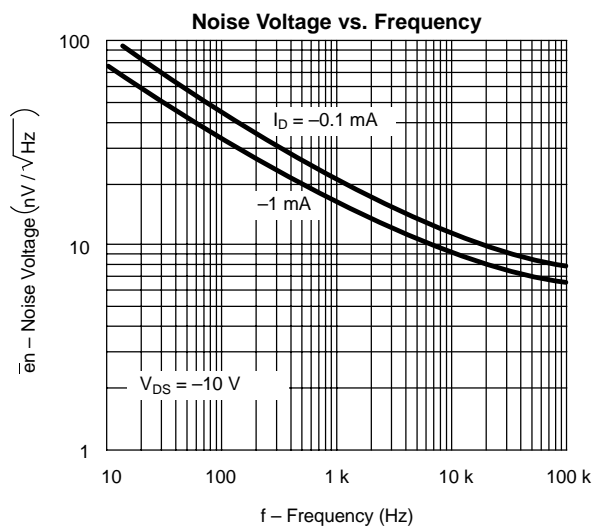
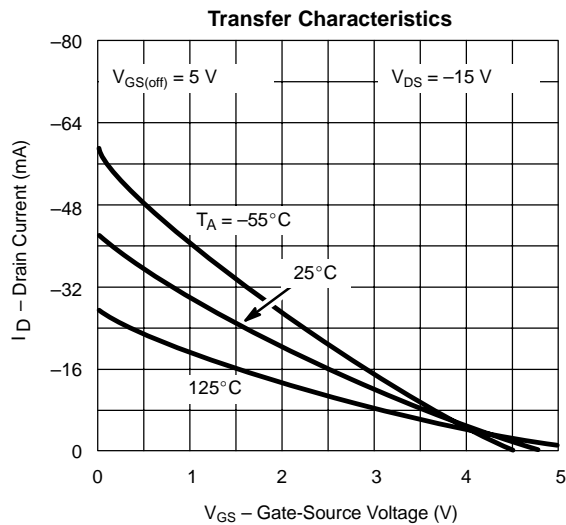
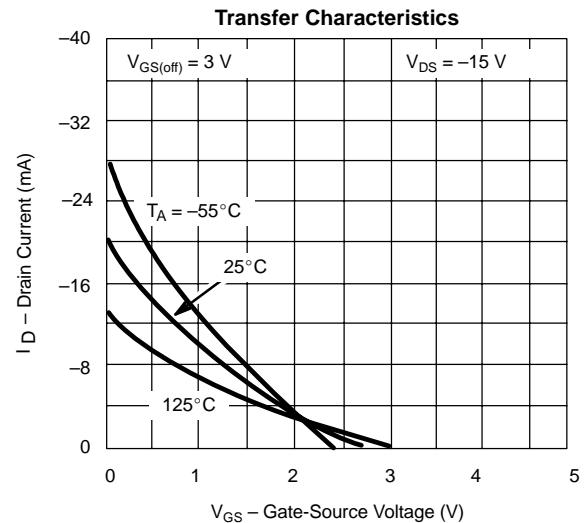
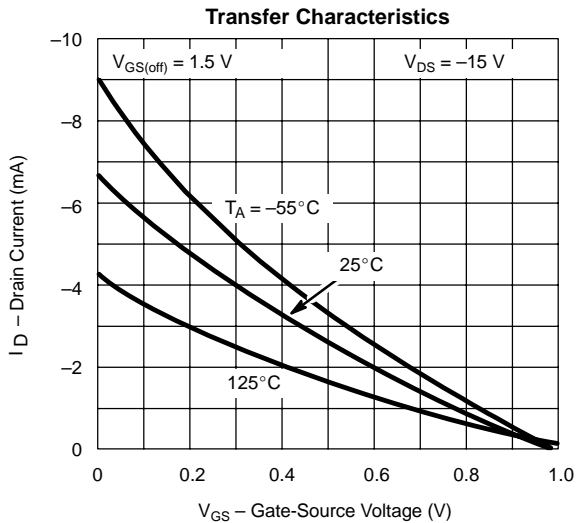
TYPICAL CHARACTERISTICS ($T_A = 25^\circ\text{C}$ UNLESS OTHERWISE NOTED)

SWITCHING TIME TEST CIRCUIT			
	2N5114	2N5115	2N5116
V_{DD}	-10 V	-6 V	-6 V
V_{GG}	20 V	12 V	8 V
R_L^*	430 Ω	910 Ω	2 k Ω
R_G^*	100 Ω	220 Ω	390 Ω
$I_{D(on)}$	-15 mA	-7 mA	-3 mA
$V_{GS(H)}$	0 V	0 V	0 V
$V_{GS(L)}$	-11 V	-7 V	-5 V

*Non-inductive

INPUT PULSE

Rise Time < 1 ns
 Fall Time < 1 ns
 Pulse Width 100 ns
 PRF 1 MHz

SAMPLING SCOPE

Rise Time 0.4 ns
 Input Resistance 10 M Ω
 Input Capacitance 1.5 pF

See Typical Characteristics curves for changes.

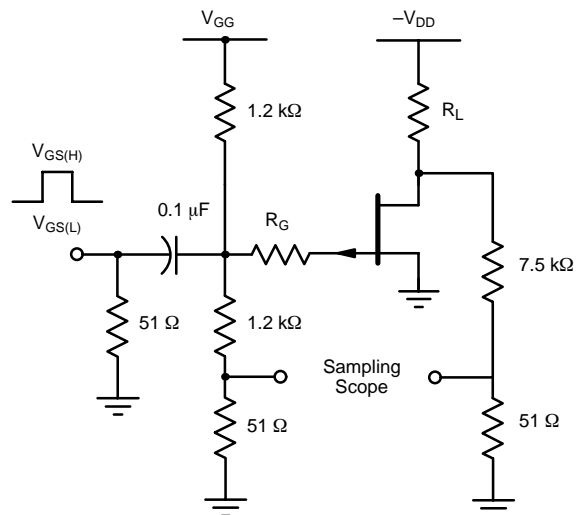



Disclaimer

All product specifications and data are subject to change without notice.

Vishay Intertechnology, Inc., its affiliates, agents, and employees, and all persons acting on its or their behalf (collectively, "Vishay"), disclaim any and all liability for any errors, inaccuracies or incompleteness contained herein or in any other disclosure relating to any product.

Vishay disclaims any and all liability arising out of the use or application of any product described herein or of any information provided herein to the maximum extent permitted by law. The product specifications do not expand or otherwise modify Vishay's terms and conditions of purchase, including but not limited to the warranty expressed therein, which apply to these products.

No license, express or implied, by estoppel or otherwise, to any intellectual property rights is granted by this document or by any conduct of Vishay.

The products shown herein are not designed for use in medical, life-saving, or life-sustaining applications unless otherwise expressly indicated. Customers using or selling Vishay products not expressly indicated for use in such applications do so entirely at their own risk and agree to fully indemnify Vishay for any damages arising or resulting from such use or sale. Please contact authorized Vishay personnel to obtain written terms and conditions regarding products designed for such applications.

Product names and markings noted herein may be trademarks of their respective owners.