

NEW

OMRON

RFID System

V680 Series

Next-Generation RFID System
Conforming to ISO/IEC 18000-3
(ISO/IEC 15693).

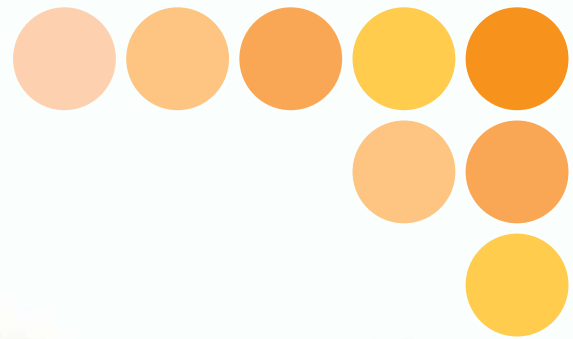

Visualize data transmission on production lines.



Managing process instructions and histories for engine manufacturing

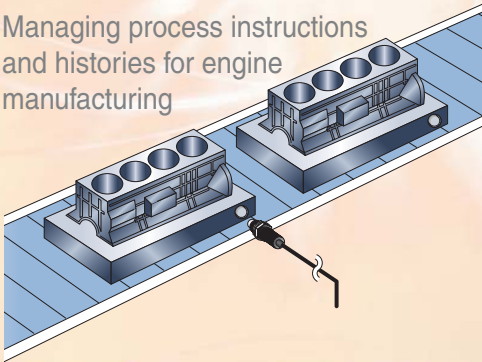

Managing manufacturing process traceability

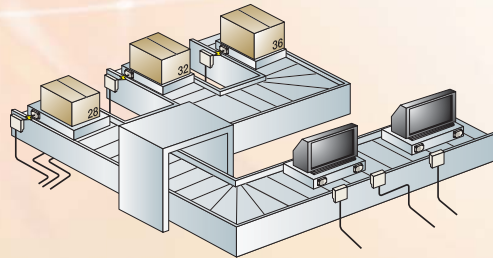

Managing the manufacture of LCDs and color filters

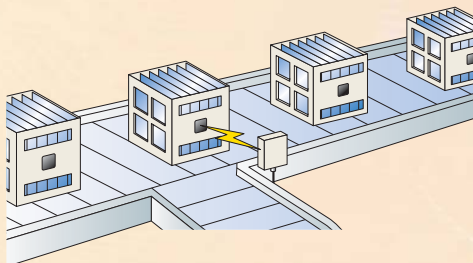

Managing dies, die histories, and die service lives

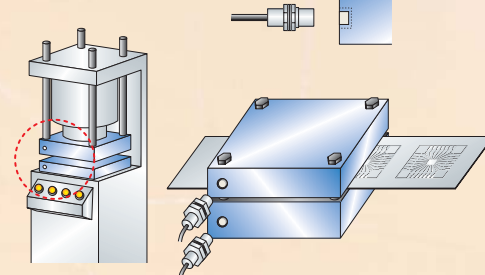

realizing

Versatile Functions for Optimal Use on Production Lines

Conforms to ISO/IEC 18000-3 (ISO/IEC 15693)

Can be used in many countries around the world.

The V680 Series can be used in many parts of the world because it meets the requirements of radio wave regulations in Japan, Europe, the U.S.A., Canada, Mexico, Singapore, Malaysia, the Philippines, China, Hong Kong, Taiwan, and Korea. Contact your OMRON sales representative for details on use in other countries.

Enables High-speed Data Transmission

High-speed transmission of 27 kbps achieved.

The V680 Series offers data transmission speeds as high as 27 kbps at an operating frequency of 13.56 MHz, and dramatically shortens turn around time (TAT) with a Self-execution Mode that eliminates the need for host access.

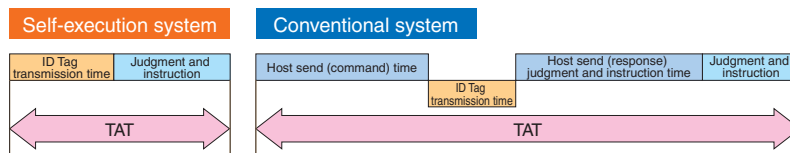

A Wide Range of ID Tags Available for Various Production Lines

These ultra-compact Tags also feature high environmental durability, long service lives, and maintenance-free operation.

- ID Tags can be either embedded in metal or mounted on non-metallic objects without requiring any extra attachments.
 - A long service life enables 10 billion accesses. (for tag which Memory type use FRAM)
 - A new battery-less model with a large, 32-Kbyte capacity has been added to the line-up. In addition to managing the growing amount of production and quality data on today's factory floors, this new Tag makes it easy to build a system with traceability.
- The V680 Series features the same level of environmental durability as the previous V600 Series.



10 billion accesses
Long service life

Battery-less

No Changes Needed when Switching from an Existing System

The V680 Series also supports V600-series commands, so there is no need to change command systems.

Easier Startup and Maintenance. Simpler Operation.

Lets You Visualize Data Transmission

Contributes to higher efficiency for on-site startup and maintenance.

Seven maintenance modes make it easy to diagnose the optimal usage conditions for the V680 RFID System. Startup is also easier because the system can be checked without having to use a personal computer or other host device.

Maintenance modes are quickly switched with the DIP switch on the front of the Controller.

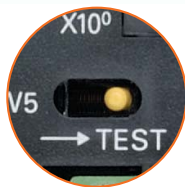

The Amplifier Unit is also equipped with an indicator that displays the communications condition, for easy confirmation from the location nearest the production line.



Strong Support for Creating ID Tag Memory Maps

Using the ID Map Manager dramatically shortens the time required to allocate ID Tag memory and complete system designs.

Work efficiency is greatly increased because the ID Map Manager includes an ID Tag read/write test function and communications checking function in addition to memory map definition and editing functions. Memory map data created by the ID Map Manager can also be easily shared between the production line design department and the vendors that are building the line.

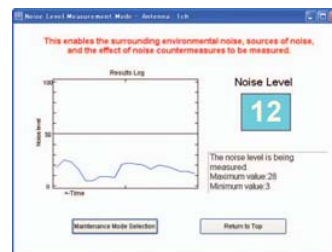
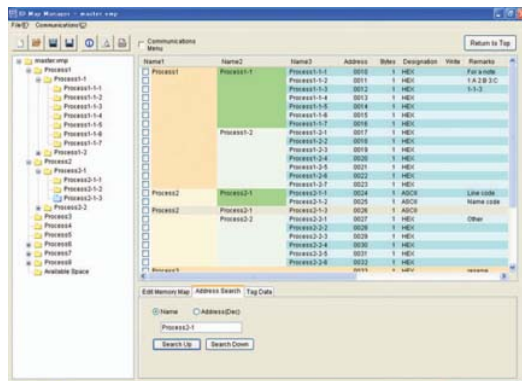

Visualize Data Transmission without the Need for a Host Device. Perform Simple Diagnosis of Communications Conditions.

Distance Level Measurement Mode

Confirms correct mounting positions for the Read/Write Antenna and ID Tag.

The distance between the Read/Write Antenna and ID Tag mounting locations relative to the communications range is displayed using six levels.

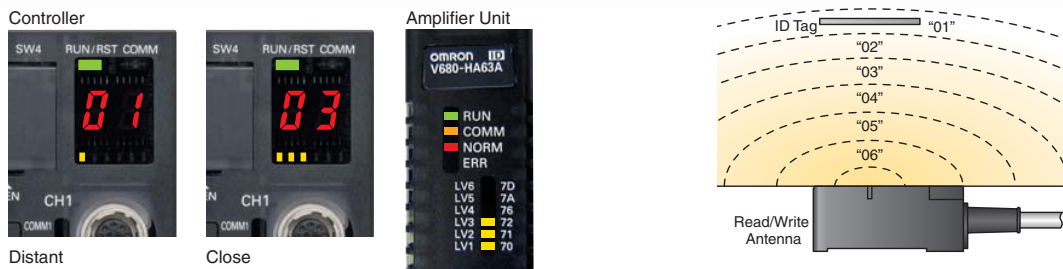

Noise Level Measurement Mode

Confirms spatial noise, noise sources, and noise countermeasure effects.

Measures the ambient noise level and displays it in levels ranging from 00 to 99.

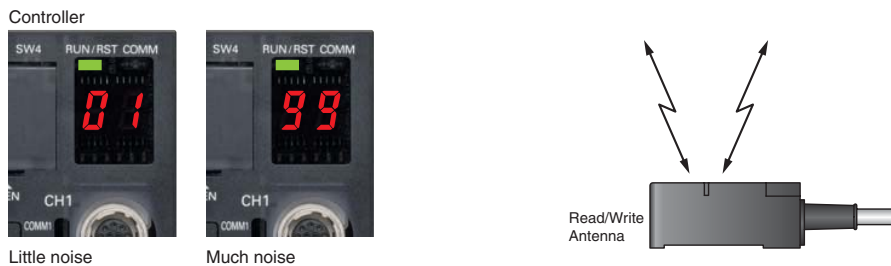

Speed Level Measurement Mode (Read/Write)

Confirms the speed of moving ID Tags and the number of usable bytes.

Data is transmitted repeatedly to moving ID Tags, and the number of successful communications and speed level are displayed in levels ranging from 01 to 99. (No data is actually written to the ID Tags during the write part of the Speed Level Measurement Mode.)

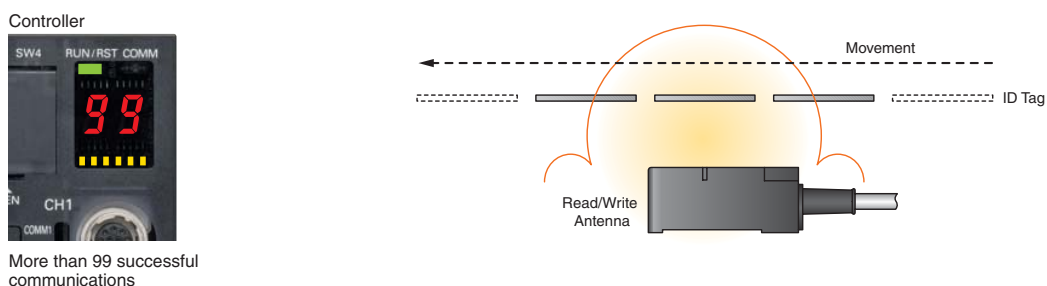

Seven maintenance modes make it easy to diagnose the communications conditions from the front panel of the Controller or Amplifier Unit. The data can also be output from the USB port of the Controller to a personal computer or other monitoring device.

(Maintenance Mode cannot be used with the V680-H01 or V680-CH.)

Communications Success Rate Measurement Mode

Confirms the communications success rate between the Read/Write Antenna and ID Tags.

A total of 100 communications are executed without retries, and the rate of communications success is displayed in levels ranging from 01 to 99.

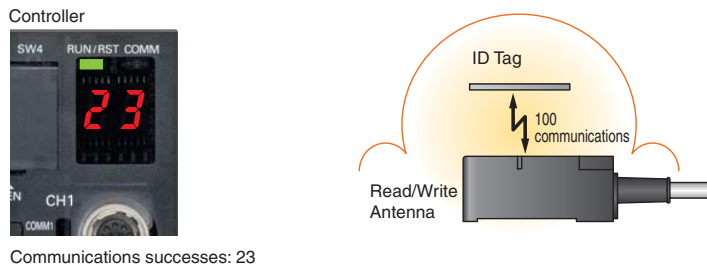

Host Device Communications Monitor Mode (Protocol Analyzer Function)

This mode can be used as a protocol analyzer function for host device communications lines.

The communications commands sent from the host device and the execution result responses can be output from the USB port of the Controller.

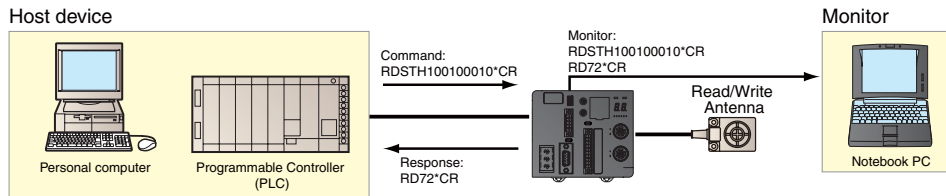

Tag Communications Test Mode

Confirms communications ability between the Read/Write Antenna and ID Tags.

The end codes are displayed to show the results of communications between the Read/Write Antenna and ID Tags. When the Controller is mounted inside a control panel, or in some other location, this data can be output from the Controller's USB port and easily checked on a monitor.

(The Tag Communications Test Mode uses only read operations.)



Host Device Communications Confirmation Mode

Confirms whether the signals sent from the Controller are being correctly transferred to an external device.

The communications commands and responses between the Controller and a host device are output from the Controller's USB port for easy identification of problems, such as incorrect communications parameters or wiring.

RFID System V680 Series

New, Next-generation RFID Systems with ISO/IEC 18000-3 (ISO/IEC15693) Compliance

- High-Speed, 27kbps communication rate. For V680-D□KF68, communication rate from tag to Antenna is 53kbps.
- Read/Write Antennas and ID Tags with excellent environmental resistance.
- Wide line-up of ultra-compact, long-life ID Tags, with capacities from 1 to 32 kbytes.
- Seven modes make it possible to visualize data transmission.
- ID Map Manager simplifies memory map designing for ID Tags.
- Complies with FCC Standards and R&TTE Directive.



System Configuration

Connect V680 Read/Write Antennas and Amplifier Units to a V680-series Controller, and read or write data from or to ID Tags.

Controller Type

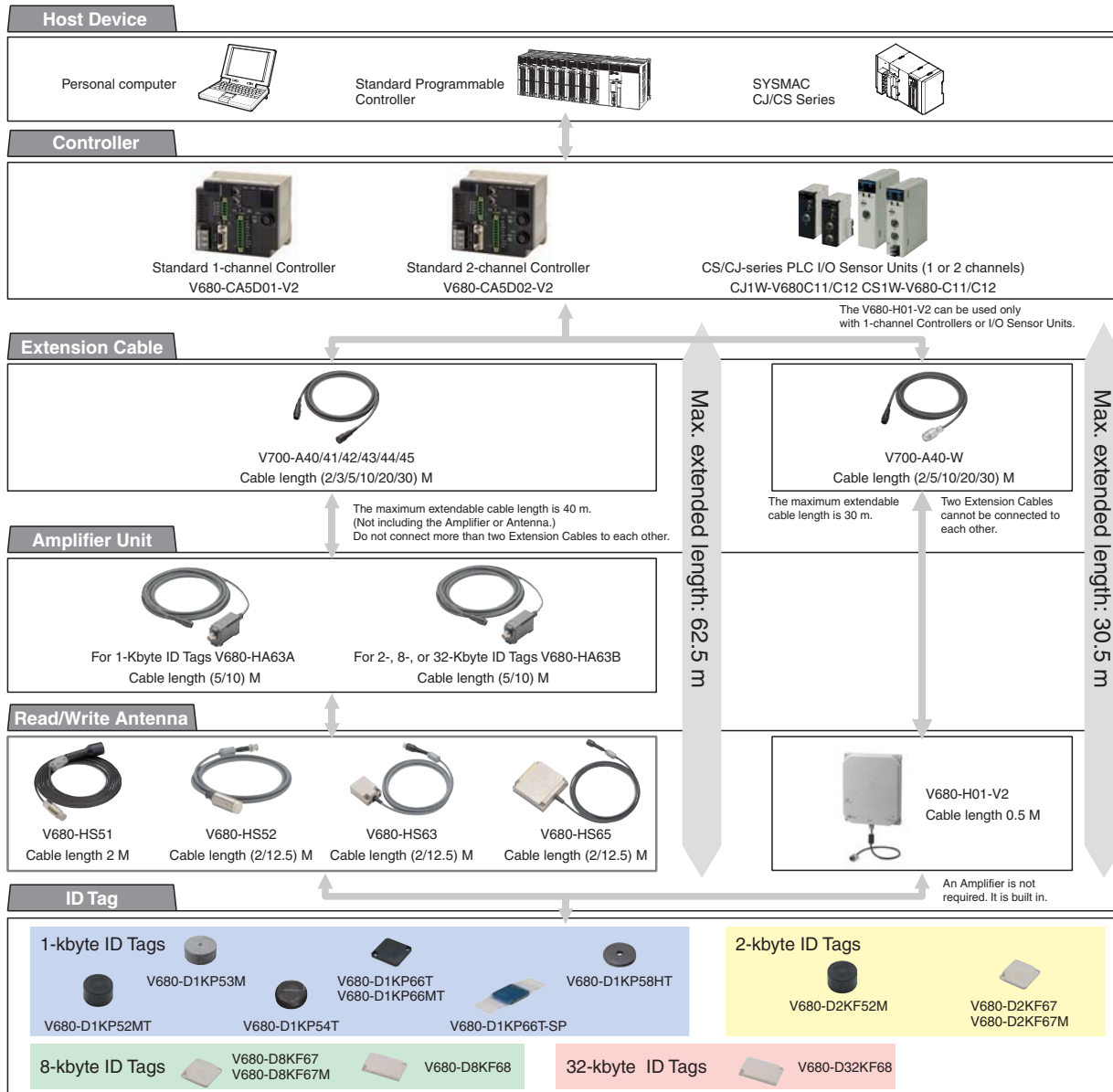

Handheld Type

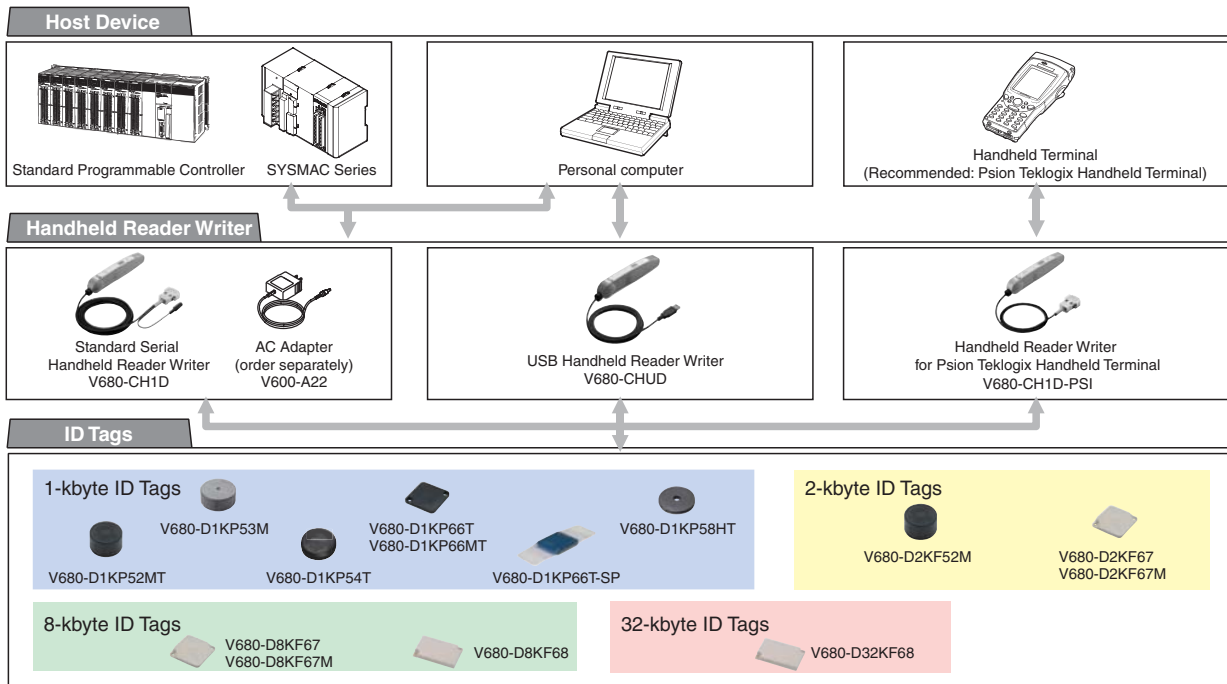

Connection List for Amplifier Unit, Antena, and Tag

Amplifier Unit	Antenna	EEPROM							
		1-kbyte							
		V680-D1KP52MT	V680-D1KP53M	V680-D1KP54T	V680-D1KP66T	V680-D1KP66MT	V680-D1KP66T-SP	V680-D1KP58HT	
For 1-kbyte ID Tags V680-HA63A	V680-HS51	●	●						
	V680-HS52	●	●	●	●	●	●		
	V680-HS63	● (See note 1.)		●	●	●	●		
	V680-HS65			●	●	●	●		
V680-H01-V2 (Read/Write Antenna with Built-in Amplifier)				●				●	
V680-CH□D (Handheld Rader Writer)		●	●	●	●	●	●	●	

Amplifier Unit	Antenna	FRAM						
		2-kbyte			8-kbyte			32-kbyte
		V680-D2KF52M	V680-D2KF67	V680-D2KF67M	V680-D8KF67	V680-D8KF67M	V680-D8KF68	V680-D32KF68
For 2/8/32-kbyte ID Tags V680-HA63B	V680-HS51	●						
	V680-HS52	●	●	●	●	●		
	V680-HS63	● (See note 1.)	●	●	●	●	●	●
	V680-HS65		●	●	●	●	●	●
V680-H01-V2 (Read/Write Antenna with Built-in Amplifier)			●		●	●	●	●
V680-CH□D (Handheld Rader Writer)		●	●	●	●	●	●	●











Note 1. Use a V680-HS51/HS52 Antenna if the V680-D1KP52MT or V680-D2KF52M is to be embedded in metal. V680-HS63 Antenna can not be used in this condition.

2. For details, refer to the following User's Manuals (Cat. No. Z248, Z249, Z262, Z271 and Z272).

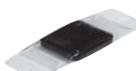



Transmission is also possible with ID Tags other than those of the V680 Series as long as they comply with ISO/IEC 18000-3 (ISO/IEC 15693). However, transmission with ID Tags other than those of the V680 Series cannot be assured. The user must confirm transmission capabilities carefully prior to use.

Ordering Information

ID Tag

Type	Memory capacity	Appearance	Size	Metallic compatibility	Model
Battery-less	1 kbyte		8 dia. × 5 mm	For embedding in metallic or non-metallic surface	V680-D1KP52MT
			10 dia. × 4.5 mm	For embedding in metallic or non-metallic surface	V680-D1KP53M
			20 dia. × 2.7 mm	For flush mounting on non-metallic surface	V680-D1KP54T
			34 × 34 × 3.5 mm	For flush mounting on metallic surface	V680-D1KP66MT
				For flush mounting on non-metallic surface	V680-D1KP66T
			95 × 36.5 × 6.5 mm	For flush mounting on non-metallic surface	V680-D1KP66T-SP
		80 dia. × t10 mm	For flush mounting on non-metallic surface	V680-D1KP58HT	
	2 kbytes		8 dia. × 5 mm	For embedding in metallic or non-metallic surface	V680-D2KF52M
			40 × 40 × 4.5 mm	For flush mounting on metallic surface	V680-D2KF67M
			For flush mounting on non-metallic surface	V680-D2KF67	
	8 kbytes		For flush mounting on metallic surface	V680-D8KF67M	
			For flush mounting on non-metallic surface	V680-D8KF67	
		86 × 54 × 10 mm	For flush mounting on non-metallic surface	V680-D8KF68	
32 kbytes			V680-D32KF68		

Read/Write Antenna (Detachable Amplifier Unit Type)

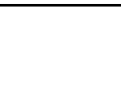
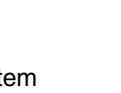

Type	Appearance	Size	Cable length	Model	
Cylindrical		M22 × 65 mm	2 m	V680-HS52-W 2M	
			12.5 m	V680-HS52-W 12.5M	
	Flexible cable, non-waterproof connector		M12 × 35 mm	2 m	V680-HS52-R 2M
				12.5 m	V680-HS52-R 12.5M
Standard cable, non-waterproof connector			2 m	V680-HS51 2M	
Square		40 × 53 × 23 mm	2 m	V680-HS63-W 2M	
			12.5 m	V680-HS63-W 12.5M	
	Flexible cable, non-waterproof connector		100 × 100 × 30 mm	2 m	V680-HS63-R 2M
				12.5 m	V680-HS63-R 12.5M
	Standard cable, waterproof connector			2 m	V680-HS65-W 2M
				12.5 m	V680-HS65-W 12.5M
	Flexible cable, non-waterproof connector			2 m	V680-HS65-R 2M
				12.5 m	V680-HS65-R 12.5M

Read/Write Antenna with Built-in Amplifier



Type	Appearance	Size	Cable length	Model
Square		250 × 200 × 35 mm	0.5 m (See note.)	V680-H01-V2

Note: Use an Antenna Cable (V700-A40-W □M) to connect the Read/Write Antenna to the Controller.
The maximum cable length is 30.5 m.

Amplifier Unit

Type	Appearance	Size	Cable length	Model
For 1-kbyte memory		25 × 40 × 65 mm	5 m	V680-HA63A 5M
			10 m	V680-HA63A 10M
For 2-/8-/32-kbyte memory		25 × 40 × 65 mm	5 m	V680-HA63B 5M
			10 m	V680-HA63B 10M

Controller

Type	No. of connectable Amplifiers	Appearance	Size	Transmission interface	Model
DC power supply	Single		105 × 90 × 65 mm	RS232C, RS422/RS485	V680-CA5D01-V2
	Dual				V680-CA5D02-V2

ID Sensor Units

Type	Unit name	Connected ID System	External power supply	No. of unit numbers used	Current consumption (A)			Model	
					5 V	24 V	External		
CJ1 Special I/O Unit		V680 Series	1 Head	---	1 unit number	0.26	0.13 (See note.)	---	CJ1W-V680C11
						2 Heads	2 unit number	0.32	0.26





Type	Unit name	Connected ID System	External power supply	No. of unit numbers used	Current consumption (A)			Model	
					5 V	26 V	External		
CS1 Special I/O Unit		V680 Series	1 Head	---	1 unit number	0.26	0.13 (See note.)	---	CS1W-V680C11
						2 Heads	24 VDC	2 unit number	0.32

Note: When connected to the V680-H01: 0.28 A

Handheld Reader Writers

Name	Model
Model with standard serial connector	V680-CH1D
Model with USB connector and 0.8-m cable	V680-CHUD 0.8M
Model with USB connector and 1.9-m cable	V680-CHUD 1.9M
Models for Psion Teklogix Handheld Terminal	V680-CH1D-PSI
AC Adapter (for V680-CH1D)	V600-A22

**Accessories (Order Separately)
ID Tag Attachment**

Type	Appearance	Model
For the V680-D1KP66T		V600-A86
For the V680-D□KF68		V680-A81
To mount the V680-D1KP58HT		V680-A80
For the V680-D1KP54T		V700-A80

Amplifier Unit Special Extension Cable (Amplifier Unit to Controller)

Cable length	Appearance	Model
2 m		V700-A40 2M.
3 m		V700-A41 3M.
5 m		V700-A42 5M.
10 m		V700-A43 10M.
20 m		V700-A44 20M.
30 m		V700-A45 30M.

Note: The cable can be extended up to 40 m. Up to two extension cables can be used.

V680-H01 Read/Write Antenna Special Cable (Read/Write Antenna to Controller)

Cable length	Appearance	Model
2 m		V700-A40-W 2M
5 m		V700-A40-W 5M
10 m		V700-A40-W 10M
20 m		V700-A40-W 20M
30 m		V700-A40-W 30M

Note: The cable can be extended up to 30 m. Only one extension cable can be used.

RS-232C Communications Connector

Name	Model
Connector Plug	XM3B-0922-111
Connector Hood	XM2S-0911

Note: An RS422/RS485 Communications Connector is attached to the Controller (V680-CA5D0X-V2).

ID Map Manager (for Windows)

Type	Model
English version	V680-A-IMMEG-P01

Psion Teklogix Handheld Terminals

We recommend connecting the V600-V680-CH-PSI Handheld Reader Writer to a Psion Teklogix WORKABOUT PRO-series Handheld Terminal. Psion Teklogix products can be purchased directly from OMRON.

Handheld Terminal Set

Name	Configuration	OMRON model number
Handheld Terminal Set (English OS)	Handheld Terminal, Serial End Cap, hand strap, charger (standard model), and High-capacity Battery	V680-A-7527S-G2-EG-S

Note: The Handheld Terminal Set includes the V600/V680 EasyAccess/CBAccess Demo Software preinstalled in a 7527S-G2 Psion Teklogix Handheld Terminal and the configuration parts listed above.

Handheld Terminal Only

Name	Configuration	Appearance	OMRON model number
Handheld Terminal (English OS)	Handheld Terminal, Serial End Cap, and hand strap (Battery sold separately.)		V680-A-7527S-G2-EG

Note: The Handheld Terminal includes the V600/V680 EasyAccess/CBAccess Demo Software preinstalled in a 7527S-G2 Psion Teklogix Handheld Terminal and the configuration parts listed above. The High-capacity Battery is not included.

Handheld Terminal Accessories

Name	Appearance	Psion Teklogix model number	OMRON model number
High-capacity Battery		WA3006	V680-A-WA3006
Charger (standard model)		PS1050-G1	V680-A-CA1053
Charger (advanced model)		WA4003-G2	V680-A-WA4003
Carrying Case		WA6197-G2	V680-A-WA6197

Refer to the following website for detailed information on Psion Teklogix Handheld Terminals.
<http://www.psionteklogix.com/products/handheld/workaboutpro.htm>

Ratings and Performance

ID Tag (1-kbyte Memory)

Item	Model	V680-D1KP52MT	V680-D1KP53M	V680-D1KP54T	V680-D1KP66T	V680-D1KP66MT	V680-D1KP66T-SP
Memory capacity		1,000 byte (user area)					
Memory type		EEPROM					
Data backup time (See note 1.)		10 years after writing (85°C max.)					
Memory longevity		100,000 times per block (at 25°C)					
Ambient operating temperature (during transmission)		-25 to 85°C (with no icing)					-25 to 70°C (with no icing)
Ambient storage temperature (during data backup)		-40 to 125°C (with no icing) Heat resistance: 1,000 thermal cycles each of 30 minutes at -10°C/150°C, High-temperature storage: 1,000 hours at 150°C (See note 2.) 200 thermal cycles each of 30 minutes at -10°C/180°C, High-temperature storage: 200 hours at 180°C (See note 3.)					-40 to 110°C (with no icing)
Ambient operating humidity		35 to 95%					
Degree of protection		IEC 60529, IP68 In-house standard for antenna oil resistance (former JEM1030 standard equivalent to IP67g) (See note 4.)					IP67
Vibration resistance		10 to 2,000 Hz, 1.5-mm double amplitude at 150 m/s ² acceleration with 10 sweeps in X, Y, and Z directions for 15 minutes each					
Shock resistance		500 m/s ² in X, Y, and Z directions 3 times each (18 times in total)					
Appearance		8 dia. × 5 mm	10 dia. × 4.5 mm (DIN698373)	20 dia. × 2.7 mm	34 × 34 × 3.5 mm		95 × 36.5 × 6.5 mm (excluding protrusions)
Materials		Case: PPS resin Filling: Epoxy resin		Molding: PPS resin			External resin: PFA Tag body: PPS resin
Weight		Approx. 0.5 g	Approx. 1 g	Approx. 2 g	Approx. 6 g	Approx. 7.5 g	Approx. 20 g
Metallic compatibility		Yes	Yes	No	No	Yes	No

Note 1. Refer to the *User's Manual* (Cat. No. Z262) for data backup time for temperatures of 85°C or higher. If the V680 has been stored at 125°C or higher, write the data again even if the data does not need to be changed.

- 150°C heat resistance: The heat resistance has been checked at 150°C for up to 1,000 hours, and thermal shock has been checked through testing 1,000 thermal cycles each of 30 minutes at -10/150°C. (Test samples: 22, defects: 0)
- 180°C heat resistance: The heat resistance has been checked at 180°C for up to 200 hours, and thermal shock has been checked through testing 200 thermal cycles each of 30 minutes at -10°C/180°C. (Test samples: 22, defects: 0)
- This OMRON in-house standard confirms resistance to cutting and other oils. It is equivalent to the former JEM1030 standard.
- For details, refer to the *User's Manual* (Cat. No. Z262).

ID Tag with 1-kbyte Memory with High-temperature Capability

Item	Model	V680-D1KP58HT
Memory capacity		1,000 byte (user area)
Memory type		EEPROM
Data backup time		10 years after writing (See note.)
Memory longevity		100,000 times per block (at 85°C)
Ambient operating temperature (during transmission)		-10 to 85°C (with no icing)
Ambient storage temperature (during data backup)		-40 to 110°C (with no icing) Heat resistance: 2,000 thermal cycles each of 30 minutes at room temperature/200°C (Refer to Heat Resistance, below, for details.)
Ambient operating humidity		No limits.
Degree of protection		IEC 60529, IP67
Vibration resistance		10 to 2,000 Hz, 3.0-mm double amplitude at 150 m/s ² acceleration with 10 sweeps in X, Y, and Z directions for 15 minutes each
Shock resistance		500 m/s ² in X, Y, and Z directions 3 times each (18 times in total)
Materials		PPS resin
Weight		Approx. 90 g

Note: The data storage time at high temperatures (110 to 200°C) is 10 hours. Rewrite the data before 10 hours has lapsed.

Heat Resistance

Sufficient heat resistance has been confirmed by evaluation testing comprising 2,000 thermal cycles each of 30 minutes at room temperature/200°C.

The lifetime of the V680-D1KP58HT is affected by high-temperature storage, due to the effects of high temperatures on internal components. For details on the relationship between heat resistance and lifetime, refer to the *User's Manual* (Cat. No. Z262).

ID Tag (2-kbyte Memory)

Item	Model	V680-D2KF52M	V680-D2KF67	V680-D1KF67M
Memory capacity		2,000 bytes (user area)		
Memory type		FRAM		
Data backup time (See note 1.)		10 years after writing (55°C or less)		
Memory longevity		10 billion times per block. Access frequency (See note 2.): 10 billion times		
Ambient operating temperature		-25 to 85°C (with no icing)		
Ambient storage temperature		-40 to 85°C (with no icing)		
Ambient operating humidity		35 to 95%	35 to 85%	
Degree of protection		IEC 60529, IP67 In-house standard for antenna oil resistance (former JEM1030 standard equivalent to IP67g) (See note 3.)		
Vibration resistance		10 to 2,000 Hz, 1.5-mm double amplitude at 150 m/s ² acceleration with 10 sweeps in X, Y, and Z directions for 15 minutes each		
Shock resistance		500 m/s ² in X, Y, and Z directions 3 times each (18 times in total)		
Appearance		8 dia. × 5 mm	40 × 40 × 4.5 mm	
Materials		Case: PPS resin Filling: Epoxy resin	Molding: PBT resin Filling: Epoxy resin	
Weight		Approx. 0.5 g	Approx. 6.5 g	Approx. 7 g
Metallic compatibility		Yes	No	Yes

- Note 1.** Refer to the *User's Manual* (Cat. No. Z248) for data backup time for temperatures of 55°C or higher.
- 2.** The total Read or Write communication frequency is called the access frequency.
- 3.** This OMRON in-house standard confirms resistance to cutting and other oils. It is equivalent to the former JEM1030 standard.
- 4.** For details, refer to the *User's Manual* (Cat. No. Z248).

ID Tag with 8-/32-kbyte Memory

Item	Model	V680-D8KF67	V680-D8KF67M	V680-D8KF68	V680-D32KF68
Memory capacity		8,192 bytes (user area)			32,744 bytes (user area)
Memory type		FRAM			
Data backup time (See note 1.)		10 years (at 70°C max.) after data is written			
Memory longevity		10 billion times per block at 85°C max. Access frequency (See note 2.): 10 billion times			
Ambient operating temperature		-20 to 85°C (with no icing)			
Ambient storage temperature		-40 to 85°C (with no icing)			
Ambient operating humidity		35 to 85%			
Degree of protection		IEC 60529, IP67 In-house standard for antenna oil resistance (former JEM1030 standard equivalent to IP67g) (See note 3.)			
Vibration resistance		10 to 2,000 Hz, 1.5-mm double amplitude at 150 m/s ² acceleration with 10 sweeps in X, Y, and Z directions for 15 minutes each	10 to 500 Hz, 1.5-mm double amplitude at 100 m/s ² acceleration with 10 sweeps in X, Y, and Z directions for 11 minutes each		
Shock resistance		500 m/s ² in X, Y, and Z directions 3 times each (18 times in total)			
Dimensions		40 × 40 × 4.5 mm		86 × 54 × 10 mm	
Materials		Case: PBT resin Filling: Epoxy resin			
Weight		Approx. 8 g	Approx. 8.5 g	Approx. 50 g	
Metallic compatibility		No	Yes	No	

- Note 1.** Refer to the *User's Manual* (Cat. No. Z248) for data backup time for temperatures of 70°C or higher.
- 2.** The total Read or Write communication frequency is called the access frequency.
- 3.** This OMRON in-house standard confirms resistance to cutting and other oils. It is equivalent to the former JEM1030 standard.
- 4.** For details, refer to the *User's Manual* (Cat. No. Z248).

Cylindrical Read/Write Antenna (Detachable Amplifier Unit Type)

Item	Model	V680-HS52-W (Standard Cable, Waterproof Connector)	V680-HS52-R (Flexible Cable, Non-waterproof Connector)	V680-HS51 (Standard Cable, Non-waterproof Connector)
Ambient operating temperature		-10 to 60°C (with no icing)		
Ambient storage temperature		-25 to 75°C (with no icing)		
Ambient operating humidity		35% to 95% (with no condensation)		
Insulation resistance		20 MΩ min. (at 500 VDC) between the cable terminals and the case		
Dielectric strength		1,000 VAC (50/60 Hz) for 1 minute between the cable terminals and the case with a current leakage of 5 mA max.		
Degree of protection		IP67 (IEC60529) In-house standard for antenna oil resistance (former JEM1030 standard equivalent to IP67g) (Read/Write Antenna portion) (See note 1.)	IP67 (IEC60529) In-house standard for antenna oil resistance (former JEM1030 standard equivalent to IP67g) (Read/Write Antenna portion) (See note 2.)	
Vibration resistance		10 to 500 Hz variable vibration, 1.5-mm double amplitude at 100 m/s ² acceleration, with 10 sweeps in X, Y, and Z directions for 8 minutes each		10 to 2,000 Hz variable vibration, 1.5-mm double amplitude at 150 m/s ² acceleration, with 10 sweeps in X, Y, and Z directions for 15 minutes each
Shock resistance		500 m/s ² in X, Y, and Z directions 3 times each (18 times in total)		1,000 m/s ² in X, Y, and Z directions 3 times each (18 times in total)
Appearance		M22 × 65 mm		M12 × 35 mm
Materials		ABS, brass, epoxy resin filling		
Weight		Approx. 850 g (with 12.5-m cable)		Approx. 55 g (with 2-m cable)

Note 1. The degree of protection for the Connector is IP67/IP65. This OMRON in-house standard confirms resistance to cutting and other oils. It is equivalent to the former JEM1030 standard.

2. The Connector is not waterproof. This OMRON in-house standard confirms resistance to cutting and other oils. It is equivalent to the former JEM1030 standard.

3. For details, refer to the *User's Manual* (Cat. No. Z248 or Z262).

Square Read/Write Antenna (Detachable Amplifier Unit Type)

Item	Model	V680-HS63-W (Standard Cable, Waterproof Connector)	V680-HS63-R (Flexible Cable, Non-waterproof Connector)
Ambient operating temperature		-10 to 60°C (with no icing)	
Ambient storage temperature		-25 to 75°C (with no icing)	
Ambient operating humidity		35% to 95% (with no condensation)	
Insulation resistance		20 MΩ min. (at 500 VDC) between the cable terminals and the case	
Dielectric strength		1,000 VAC (50/60 Hz) for 1 minute between the cable terminals and the case with a current leakage of 5 mA max.	
Degree of protection		IP67 (IEC60529) In-house standard for antenna oil resistance (former JEM1030 standard equivalent to IP67g) (Read/Write Antenna portion) (See note 1.)	IP67 (IEC60529) In-house standard for antenna oil resistance (former JEM1030 standard equivalent to IP67g) (Read/Write Antenna portion) (See note 2.)
Vibration resistance		10 to 500 Hz variable vibration, 1.5-mm double amplitude at 100 m/s ² acceleration, with 10 sweeps in X, Y, and Z directions for 11 minutes each	
Shock resistance		500 m/s ² in X, Y, and Z directions 3 times each (18 times in total)	
Appearance		40 × 53 × 23 mm	
Materials		ABS, epoxy resin filling	
Weight		Approx. 850 g (with 12.5-m cable)	

Item	Model	V680-HS65-W (Standard Cable, Waterproof Connector)	V680-HS65-R (Flexible Cable, Non-waterproof Connector)
Ambient operating temperature		-25 to 70°C (with no icing)	
Ambient storage temperature		-40 to 85°C (with no icing)	
Ambient operating humidity		35% to 95% (with no condensation)	
Insulation resistance		20 MΩ min. (at 500 VDC) between the cable terminals and the case	
Dielectric strength		1,000 VAC (50/60 Hz) for 1 minute between the cable terminals and the case with a current leakage of 5 mA max.	
Degree of protection		IP67 (IEC 60529) In-house standard for antenna oil resistance (former JEM1030 standard equivalent to IP67g) (Read/Write Antenna portion) (See note 1.)	IP67 (IEC 60529) In-house standard for antenna oil resistance (former JEM1030 standard equivalent to IP67g) (Read/Write Antenna portion) (See note 2.)
Vibration resistance		10 to 500 Hz variable vibration, 1.5-mm double amplitude at 100 m/s ² acceleration, with 10 sweeps in X, Y, and Z directions for 11 minutes each	
Shock resistance		500 m/s ² in X, Y, and Z directions 3 times each (18 times in total)	
Appearance		100 × 100 × 30 mm	
Materials		ABS, epoxy resin filling	
Weight		Approx. 1,100 g (with 12.5-m cable)	

Note 1. The degree of protection for the Connector is IP67/IP65. This OMRON in-house standard confirms resistance to cutting and other oils. It is equivalent to the former JEM1030 standard.

2. The Connector is not waterproof. This OMRON in-house standard confirms resistance to cutting and other oils. It is equivalent to the former JEM1030 standard.

3. For details, refer to the *User's Manual* (Cat. No. Z248 or Z262).

Square Read/Write Antenna with Built-in Amplifier

Item	Model	V680-H01-V2
Ambient operating temperature		-10 to 55°C (with no icing)
Ambient storage temperature		-35 to 65°C (with no icing)
Ambient operating humidity		35% to 85% (with no condensation)
Insulation resistance		20 MΩ min. (at 100 VDC) between the back plate and the case
Dielectric strength		1,000 VAC (50/60 Hz) for 1 minute between the back plate and the case with a current leakage of 1 mA max.
Degree of protection		IEC 60529: IP63 (Mounting direction: Transmission surface facing up)
Vibration resistance		10 to 150 Hz variable vibration, 0.7-mm double amplitude with 4 sweeps in X, Y, and Z directions for 8 minutes each
Shock resistance		150 m/s ² in X, Y, and Z directions 3 times each
Appearance		200 × 250 × 40 mm
Material		Polycarbonate (PC) resin, ASA resin / Rear Panel: Aluminum
Weight		Approx. 900 g
Cable length		0.5 m

Note: For details, refer to the *User's Manual* (Cat. No. Z248 or Z262).

Amplifier Unit

Item	Model	V680-HA63A	V680-HA63B
Ambient operating temperature		-10 to 55°C (with no icing)	
Ambient storage temperature		-25 to 65°C (with no icing)	
Ambient operating humidity		35% to 85% (with no condensation)	
Insulation resistance		20 MΩ min. (at 500 VDC) between the cable terminals and the case	
Dielectric strength		1,000 VAC (50/60 Hz) for 1 minute between the cable terminals and the case with a current leakage of 5 mA max.	
Degree of protection		IP40 (IEC60529) (See note 1.)	IP67/IP65 (IEC60529) (See note 2.)
Vibration resistance		10 to 500 Hz variable vibration, 1.5-mm double amplitude at 100 m/s ² acceleration, with 10 sweeps in X, Y, and Z directions for 11 minutes each	
Shock resistance		500 m/s ² in X, Y, and Z directions 3 times each (18 times in total)	
Appearance		25 × 40 × 65 mm (not including projections)	
Material		Polycarbonate (PC) resin	
Weight		Approx. 650 g (with 10-m cable)	
Cable length		5 m, 10 m	
Transmittable ID Tags		1-kbyte memory	2-, 8-, 32-kbyte memory

Note 1. When connected to the V680-HS63-R or V680-HS52-R.

2. When connected to the V680-HS63-W or V680-HS52-W. (Not including the Connector on the Controller.)

3. For details, refer to the *User's Manual* (Cat. No. Z248 or Z262).

Controller

Item	Model	V680-CA5D01-V2	V680-CA5D02-V2
Power supply voltage (Power consumption)		24 VDC (-15% to +10%) 15 W max., 0.8 A max.	
Communications Specifications		RS-232C, RS-422, RS-485	
Input Specifications (Input voltage) RST, TRG1, and TRG2		24 VDC (+10% to -15%, including ripple) (PNP and NPN compatible)	
Output Specifications (Maximum switching capacity) RUN, BUSY/OUTS, ERROR/OUT4, OUT1, and OUT2		24 VDC (+10% to -15%, including ripple) 100-mA photoMOS output (PNP and NPN compatible)	
Ambient operating temperature		-10 to 55°C (with no icing)	
Ambient storage temperature		-25 to 65°C (with no icing)	
Ambient operating humidity		25% to 85% (with no condensation)	
Insulation resistance		20 MΩ min. (at 500 VDC) applied as follows: (1) Between power supply terminals and grounded case (2) Between ground and terminals	
Dielectric strength		1,000 VAC (50/60 Hz) for 1 minute (1) Between power supply terminals and grounded case (2) Between ground and terminals	
Degree of protection		Panel mounted (equivalent to IP20)	
Vibration resistance		10 to 150 Hz variable vibration, 0.2-mm double amplitude at 15 m/s ² acceleration, with 10 sweeps in X, Y, and Z directions for 8 minutes each	
Shock resistance		150 m/s ²	
Appearance		105 × 90 × 65 mm (not including projections)	
Material		Polycarbonate (PC) resin, ABS resin	
Weight		Approx. 300 g	
Connectable Amplifier Units		1	2

Note: For details, refer to the *User's Manual* (Cat. No. Z249).

■ **USB Port**

The USB port is used for a simple connection with a personal computer using a USB cable. The port complies with USB 1.1, and the USB cable uses a series A or series mini-B connector. A USB port driver must be separately provided. Consult with your OMRON representative for details.

When connected to a host device via USB, the communications will use 1:1 protocol regardless of the setting of DIP switches 3 to 9.

The USB port is not used for control purposes. When building a system, be sure to provide an RS-232C port or RS-422/RS-485C port.

ID Sensor Units

Item	Model	CJ1W-V680C11	CJ1W-V680C12	CS1W-V680C11	CS1W-V680C12
Current consumption	Internal: 5 V	260 mA	320 mA	260 mA	320 mA
	Internal: 24 V/26 V	130 mA (See note.)	260 mA	125 mA (See note.)	---
	External: 24 V	---	---	---	360 mA
Ambient operating temperature		0 to 55°C			
Ambient storage temperature		-20 to 75°C			
Ambient operating humidity		10% to 90% (with no condensation)			
Insulation resistance		20 mΩ min. at 500 VDC			
Dielectric strength		1,000 VAC for 1 minute			
Degree of protection		Mounted in panel (IP30)			
Vibration resistance		10 to 57 Hz variable vibration, 0.075-mm double amplitude and 57 to 150 Hz variable vibration at 9.8 m/s ² acceleration, with 10 sweeps in X, Y, and Z directions for 8 minutes each			
Shock resistance		147 m/s ² in X, Y, and Z directions 3 times each			
Appearance		31 × 65 × 90 mm (excluding protrusions)		35 × 130 × 101 mm (excluding protrusions)	

Note: When connected to the V680-H01: 280 mA

Functional Specifications of ID Sensor Units

Item	Model	CJ1W-V680C11	CJ1W-V680C12	CS1W-V680C11	CS1W-V680C12
Communications control protocol		Special protocol for CS1 and CJ1 PLCs			
Number of Read/Write Head connections		1	2	1	2
Commands		Supported commands: Read, Write, Bit Set/Bit Clear, Mask Bit Write, Calculation Write, Data Fill, Data Check, Number of Writes Control, Copy, Read with Error Correction/Write with Error Correction, UID Read, and Noise Measurement. The following communications options are supported: Single trigger, Single auto, Repeat auto, FIFO trigger, FIFO repeat (See note.), Multi-access trigger, and Multi-access repeat (See note.)			
Data transfer quantity		2,048 bytes max. (160 bytes/scan)			
Diagnostic function		(1) CPU watchdog timer (2) Communications error detection with ID Tag (3) Antenna power supply error			
Monitoring/testing functions		Tag communications can be tested in Test Mode. Status is displayed by LED indicators.			
Number of allocated words		10 words	20 words	10 words	20 words

Note 1. Cannot be used for communications with the V680-D1KP□□□.
 2. For details, refer to the *User's Manual* (Cat. No. Z271).

Handheld Reader Writers

Item	Model	V680-CHUD 0.8M	V680-CHUD 1.9M	V680-CH1D	V680-CH1D-PSI
Power supply voltage		5 VDC±5%			
Current consumption		500 mA max. (for a power supply voltage of 5.0 V)			
Communications specifications		USB (Series A plug) Ver.1.1		RS-232C (D-SUB 9-pin) (compatible with IBM PC/AT)	RS-232C (D-SUB 9-pin)
Ambient operating temperature during communication		0 to +40°C			
Ambient storage temperature		-25 to +65°C			
Ambient operating humidity during communication		35% to 85% (with no condensation)			
Insulation resistance		50 MΩ min. (at 500 VDC) between connector and case			
Dielectric strength		1,000 VAC, 50/60 Hz for 1 min (leakage current: 1 mA max.) between connectors and case			
Degree of protection		IEC 60529: IP63 (See note 2.)			
Vibration resistance		Destruction: 10 to 150 Hz, 0.2-mm double amplitude, with 10 sweeps for 8 min each in 6 directions			
Shock resistance		Destruction: 150 m/s ² , 3 times each in X, Y, and Z directions			
Weight		Approx. 110 g (including connector and cable)	Approx. 140 g (including connector and cable)	Approx. 170 g (including connector and cable)	Approx. 120 g (including connector and cable)
Cable length		0.8 m	1.9 m	2.5 m	0.8 m













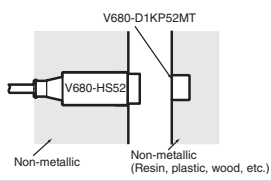

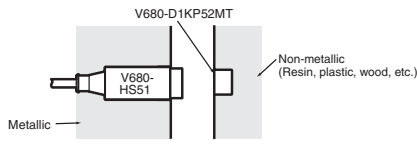

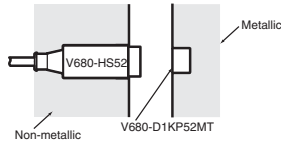

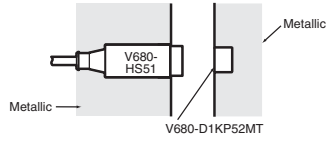
Note 1. Refer to the *User's Manual* (Cat. No. Z272) for details.
 2. This does not include the connector section. The main unit is not resistant to chemical or oils.

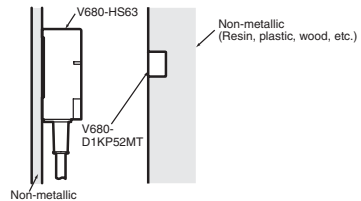
AC Adapter (for V680-CH1D)

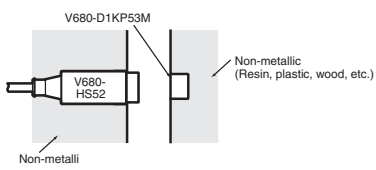

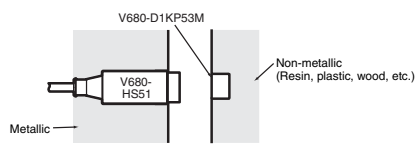

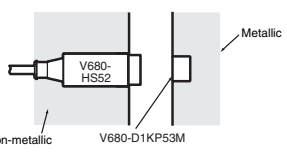

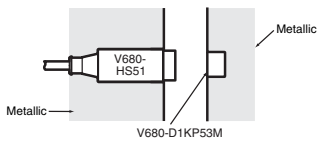





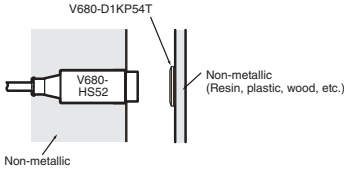

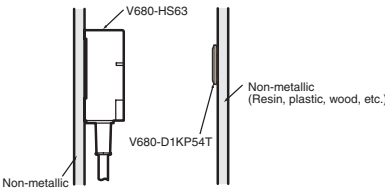
Item	Model	V600-A22
Input voltage		100 to 120 VAC at 50/60 Hz
Input current		100 VAC: 200 mA ±20%, 120 VAC: 170 mA ±20%
Output voltage		5 VDC ±0.25 V
Ambient operating temperature		0 to 40°C (with no icing)
Ambient storage temperature		-40 to 70°C (with no icing)
Ambient operating humidity		25% to 85% (with no condensation)
Insulation resistance		100 MΩ min. (at 500 VDC) between input terminals and output terminals
Dielectric strength		1,500 V for 1 minute between input terminals and output terminals with a current leakage of 5 mA max.
Weight		Approx. 85 g
Applicable standards		UL/CSA

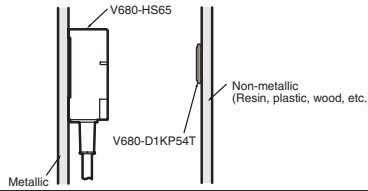
■ Performance Specifications

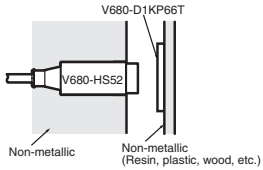

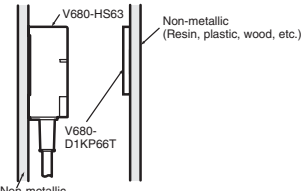

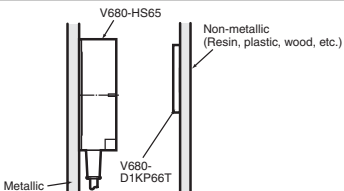

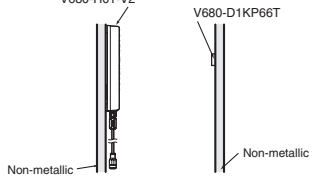





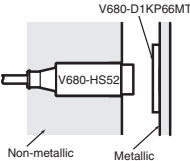

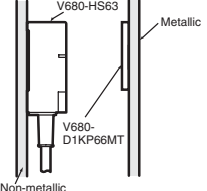
ID Tag (1-kbyte Memory) Transmission

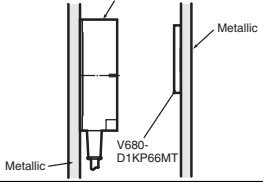
Recommended combination		Function	Transmission distance (unit: mm)	ID Tag and Read/Write Antenna mounting conditions
ID Tag	Read/Write Antenna			
		Read distance	0 to 9.0 mm (axial deviation ±2)	
		Write distance	0 to 8.5 mm (axial deviation ±2)	
		Read distance	0.5 to 6.5 mm (axial deviation ±2)	
		Write distance	0.5 to 6.0 mm (axial deviation ±2)	
		Read distance	0 to 4.5 mm (axial deviation ±2)	
		Write distance	0 to 4.0 mm (axial deviation ±2)	
		Read distance	0.5 to 3.5 mm (axial deviation ±2)	
		Write distance	0.5 to 3.5 mm (axial deviation ±2)	
		Read distance	0 to 12.0 mm (axial deviation ±2)	
		Write distance	0 to 9.5 mm (axial deviation ±2)	
		Read distance	0 to 9.0 mm (axial deviation ±2)	
		Write distance	0 to 8.5 mm (axial deviation ±2)	
		Read distance	0.5 to 6.5 mm (axial deviation ±2)	
		Write distance	0.5 to 6.0 mm (axial deviation ±2)	
		Read distance	0 to 4.5 mm (axial deviation ±2) (See note.)	
		Write distance	0 to 4.0 mm (axial deviation ±2) (See note.)	
		Read distance	0.5 to 3.5 mm (axial deviation ±2) (See note.)	
		Write distance	0.5 to 3.0 mm (axial deviation ±2) (See note.)	

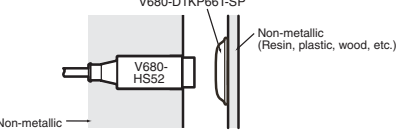
Note: When using the V680-D1KP53M embedded in metal, use the V680-HS51/-HS52 Antenna. Communications will not be possible with a V680-HS63 Antenna.

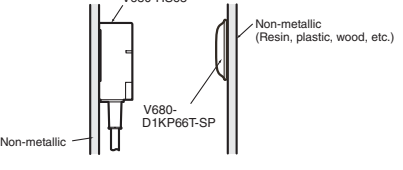

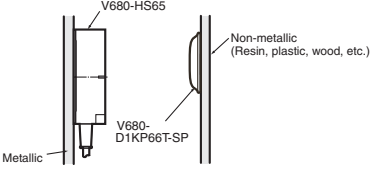

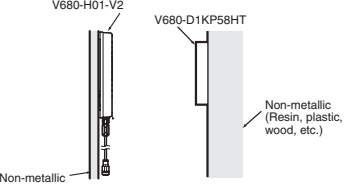







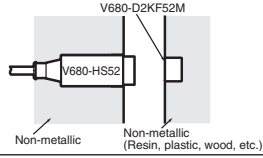

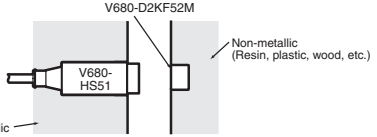

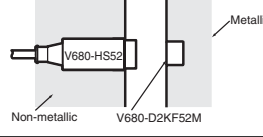

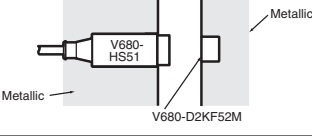
Recommended combination		Function	Transmission distance (unit: mm)	ID Tag and Read/Write Antenna mounting conditions
ID Tag	Read/Write Antenna			
		Read distance	0 to 17.0 mm (axial deviation ± 2)	
		Write distance	0 to 15.0 mm (axial deviation ± 2)	
		Read distance	0 to 24.0 mm (axial deviation ± 10)	
		Write distance	0 to 20.0 mm (axial deviation ± 10)	
		Read distance	0 to 33.0 mm (axial deviation ± 10)	
		Write distance	0 to 28.0 mm (axial deviation ± 10)	
		Read distance	0 to 17.0 mm (axial deviation ± 2) (See note 2.)	
		Write distance	0 to 17.0 mm (axial deviation ± 2) (See note 2.)	
		Read distance	0 to 30.0 mm (axial deviation ± 10) (See note 2.)	
		Write distance	0 to 25.0 mm (axial deviation ± 10) (See note 2.)	
		Read distance	0 to 47.0 mm (axial deviation ± 10) (See note 2.)	
		Write distance	0 to 42.0 mm (axial deviation ± 10) (See note 2.)	
		Read distance	0 to 100.0mm (axial deviation ± 10)	
		Write distance	0 to 100.0 mm (axial deviation ± 10)	

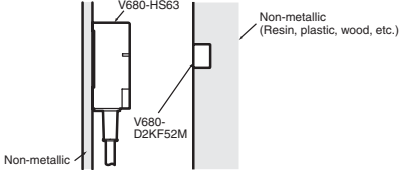
- Note 1.** When mounting the V680-HS65, be sure to attach the Mounting Brackets at the base of the Antenna. The enclosed Mounting Brackets do not need to be used, however, if the mounting brackets on the Antenna are metal plates and their dimensions are larger than the dimensions of the Antenna (100 × 100 mm). For details, refer to the *User's Manual* (Cat. No. Z248 or Z262).
- 2.** The transmission distance may be reduced if the V680-D1KP66T is mounted onto a metallic surface. Refer to the *User's Manual* (Cat. No. Z262) for details.

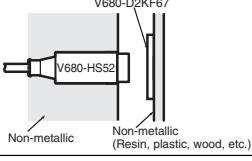

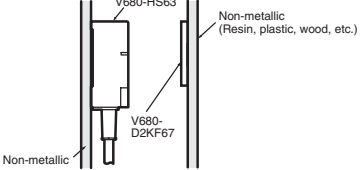

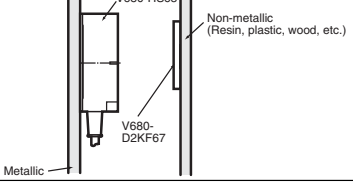

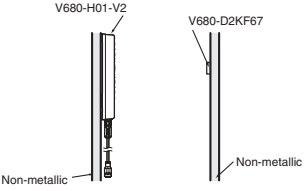
Recommended combination		Function	Transmission distance (unit: mm)	ID Tag and Read/Write Antenna mounting conditions
ID Tag	Read/Write Antenna			
		Read distance	0 to 16.0 mm (axial deviation ± 2)	
		Write distance	0 to 14.0 mm (axial deviation ± 2)	
		Read distance	0 to 25.0 mm (axial deviation ± 10)	
		Write distance	0 to 20.0 mm (axial deviation ± 10)	
		Read distance	0 to 25.0 mm (axial deviation ± 10)	
		Write distance	0 to 20.0 mm (axial deviation ± 10)	
		Read distance	0 to 17.0 mm (axial deviation ± 2)	
		Write distance	0 to 17.0 mm (axial deviation ± 2)	
		Read distance	0 to 30.0 mm (axial deviation ± 10)	
		Write distance	0 to 25.0 mm (axial deviation ± 10)	
		Read distance	0 to 47.0 mm (axial deviation ± 10)	
		Write distance	0 to 42.0 mm (axial deviation ± 10)	
		Read distance	0 to 150 mm (See note 2.)	
		Write distance		

- Note 1.** When mounting the V680-HS65, be sure to attach the Mounting Brackets at the base of the Antenna.
 The enclosed Mounting Brackets do not need to be used, however, if the mounting brackets on the Antenna are metal plates and their dimensions are larger than the dimensions of the Antenna (100 × 100 mm).
 For details, refer to the *User's Manual* (Cat. No. Z248 or Z262).
- 2.** The transmission distance may be reduced if the V680-D1KP58HT is mounted onto a metallic surface. Refer to the *User's Manual* (Cat. No. Z262) for details.

ID Tag (2-kbyte Memory) Transmission

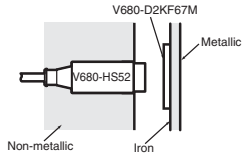

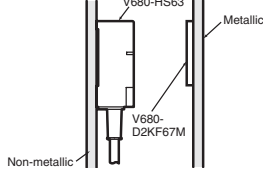

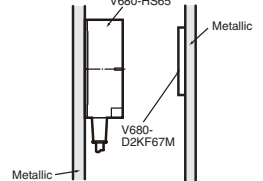



Recommended combination		Function	Transmission distance (unit: mm)	ID Tag and Read/Write Antenna mounting conditions
ID Tag	Read/Write Antenna			
		Read distance	0 to 8.0 mm (axial deviation ±2)	
		Write distance	0 to 8.0 mm (axial deviation ±2)	
		Read distance	0.5 to 5.5 mm (axial deviation ±2)	
		Write distance	0.5 to 5.5 mm (axial deviation ±2)	
		Read distance	0 to 3.0 mm (axial deviation ±2)	
		Write distance	0 to 3.0 mm (axial deviation ±2)	
		Read distance	0 to 3.5 mm (axial deviation ±2)	
		Write distance	0 to 3.5 mm (axial deviation ±2)	
		Read distance	0 to 9.5 mm (axial deviation ±2)	
		Write distance	0 to 9.5 mm (axial deviation ±2)	
		Read distance	0 to 17.0 mm (axial deviation ±2) (See note.)	
		Write distance	0 to 17.0 mm (axial deviation ±2) (See note.)	
		Read distance	7 to 30.0 mm (axial deviation ±10) (See note.)	
		Write distance	7 to 30.0 mm (axial deviation ±10) (See note.)	
		Read distance	0 to 42.0 mm (axial deviation ±10) (See note.)	
		Write distance	0 to 42.0 mm (axial deviation ±10) (See note.)	
		Read distance	0 to 100.0 mm (axial deviation ±10)	
		Write distance	0 to 100.0 mm (axial deviation ±10)	

- Note 1.** When mounting the V680-HS65, be sure to attach the Mounting Brackets at the base of the Antenna.
 The enclosed Mounting Brackets do not need to be used, however, if the mounting brackets on the Antenna are metal plates and their dimensions are larger than the dimensions of the Antenna (100 × 100 mm).
 For details, refer to the *User's Manual* (Cat. No. Z248 or Z262).
- 2.** The transmission distance may be reduced if the V680-D2KF67 is mounted onto a metallic surface. Refer to the *User's Manual* (Cat. No. Z248) for details.

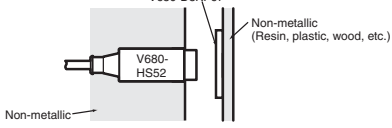

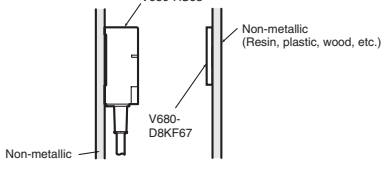

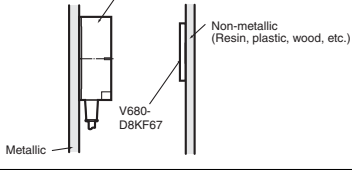

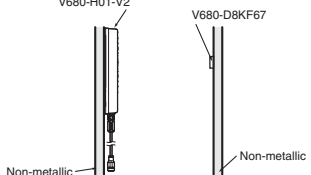

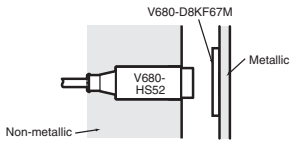

Recommended combination		Function	Transmission distance (unit: mm)	ID Tag and Read/Write Antenna mounting conditions
ID Tag	Read/Write Antenna			
		Read distance	0 to 16.0 mm (axial deviation ± 2)	
		Write distance	0 to 16.0 mm (axial deviation ± 2)	
		Read distance	6 to 25.0 mm (axial deviation ± 10)	
		Write distance	6 to 25.0 mm (axial deviation ± 10)	
		Read distance	0 to 25.0 mm (axial deviation ± 10)	
		Write distance	0 to 25.0 mm (axial deviation ± 10)	

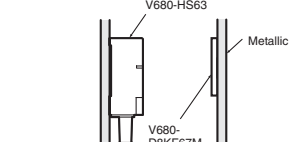
Note: When mounting the V680-HS65, be sure to attach the Mounting Brackets at the base of the Antenna.
 The enclosed Mounting Brackets do not need to be used, however, if the mounting brackets on the Antenna are metal plates and their dimensions are larger than the dimensions of the Antenna (100 × 100 mm).
 For details, refer to the *User's Manual* (Cat. No. Z248 or Z262).

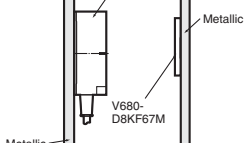
ID Tag (8-/32-kbyte Memory) Transmission

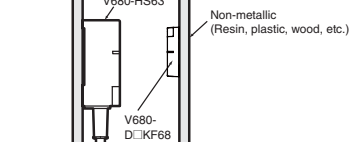
Recommended combination		Function	Transmission distance (unit: mm)	ID Tag and Read/Write Antenna mounting conditions
ID Tag	Read/Write Antenna			
		Read distance	0 to 17.0 mm (axial deviation ± 2)	
		Write distance	0 to 17.0 mm (axial deviation ± 2)	
		Read distance	0 to 30.0 mm (axial deviation ± 10)	
		Write distance	0 to 30.0 mm (axial deviation ± 10)	
		Read distance	0 to 42.0 mm (axial deviation ± 10)	
		Write distance	0 to 42.0 mm (axial deviation ± 10)	
	Read distance	0 to 100.0 mm (axial deviation ± 10)		
	Write distance	0 to 100.0 mm (axial deviation ± 10)		

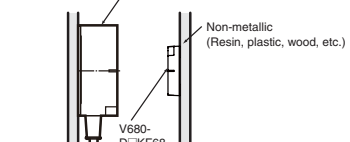

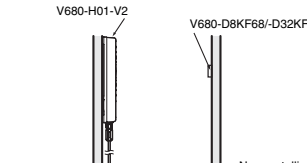
Note: When mounting the V680-HS65, be sure to attach the Mounting Brackets at the base of the Antenna.
 The enclosed Mounting Brackets do not need to be used, however, if the mounting brackets on the Antenna are metal plates and their dimensions are larger than the dimensions of the Antenna (100 × 100 mm).
 For details, refer to the *User's Manual* (Cat. No. Z248 or Z262).

Recommended combination		Function	Transmission distance (unit: mm)	ID Tag and Read/Write Antenna mounting conditions
ID Tag	Read/Write Antenna			
V680-D8KF67M (flush-mounted on metallic surface: steel)		Read distance	0 to 16.0 mm (axial deviation ±2)	
		Write distance	0 to 16.0 mm (axial deviation ±2)	
		Read distance	0 to 25.0 mm (axial deviation ±10)	
		Write distance	0 to 25.0 mm (axial deviation ±10)	
		Read distance	0 to 25.0 mm (axial deviation ±10)	
		Write distance	0 to 25.0 mm (axial deviation ±10)	
V680-D8KF68/-D32KF68		Read distance	0 to 45.0 mm (axial deviation ±10) (See note 2.)	
		Write distance	0 to 45.0 mm (axial deviation ±10) (See note 2.)	
		Read distance	0 to 75.0 mm (axial deviation ±10) (See note 2.)	
		Write distance	0 to 75.0 mm (axial deviation ±10) (See note 2.)	
		Read distance	0 to 150.0 mm (axial deviation ±10)	
		Write distance	0 to 150.0 mm (axial deviation ±10)	

Note 1. When mounting the V680-HS65, be sure to attach the Mounting Brackets at the base of the Antenna.

The enclosed Mounting Brackets do not need to be used, however, if the mounting brackets on the Antenna are metal plates and their dimensions are larger than the dimensions of the Antenna (100 × 100 mm). For details, refer to the *User's Manual* (Cat. No. Z248 or Z262).

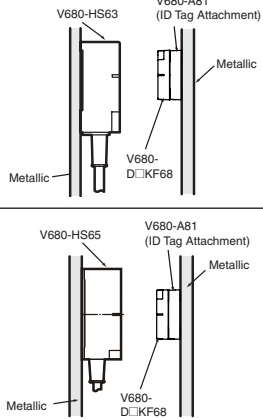
2. The transmission distance may be reduced if the V680-D8KF68 is mounted onto a metallic surface. Refer to the *User's Manual* (Cat. No. Z248) for details.

Recommended combination		Function	Transmission distance (unit: mm)	ID Tag and Read/Write Antenna mounting conditions
ID Tag	Read/Write Antenna			
V680-D8KF68/ -D32KF68 (Special attachment provided; flush-mounted on metallic surface: steel)	 V680-HS63	Read distance	0 to 35.0 mm (axial deviation ±10)	
		Write distance	0 to 35.0 mm (axial deviation ±10)	
	 V680-HS65	Read distance	0 to 55.0 mm (axial deviation ±10)	
		Write distance	0 to 55.0 mm (axial deviation ±10)	

- Note 1.** When mounting the V680-HS65, be sure to attach the Mounting Brackets at the base of the Antenna.
 The enclosed Mounting Brackets do not need to be used, however, if the mounting brackets on the Antenna are metal plates and their dimensions are larger than the dimensions of the Antenna (100 × 100 mm).
 For details, refer to the *User's Manual* (Cat. No. Z248 or Z262).
- 2.** The transmission distance may be reduced if the V680-D□KF68 is mounted onto a metallic surface. Use V680-A81 special attachment.
 Refer to the *User's Manual* (Cat. No. Z248) for details.

Characteristic Data (Typical)

Transmission Range

(unit: mm)

1-kbyte Memory ID Tag

The values given for communications ranges are reference values. Refer to pages 18 to 20 for communications distance specifications.
 The communications distance will depend on the ID Tags, ambient temperature, surrounding metal, noise, and other factors. Test operation completely when installing a system.

V680-HS52 (embedded in non-metallic material) & V680-D1KP52MT (embedded in non-metallic material)

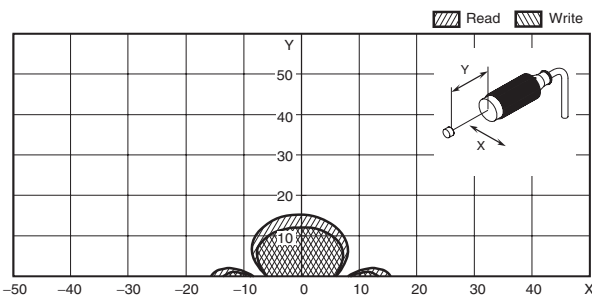

V680-HS52 (embedded in non-metallic material) & V680-D1KP52MT (embedded in metallic surface: steel)

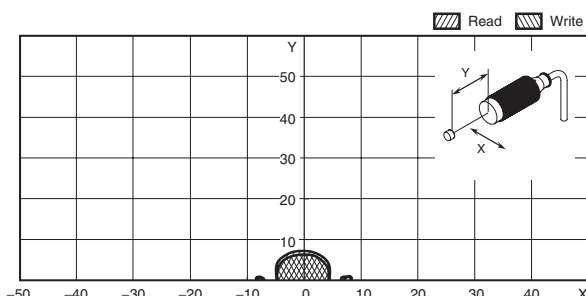

V680-HS51 (embedded in metallic material) & V680-D1KP52MT (embedded in non-metallic material)

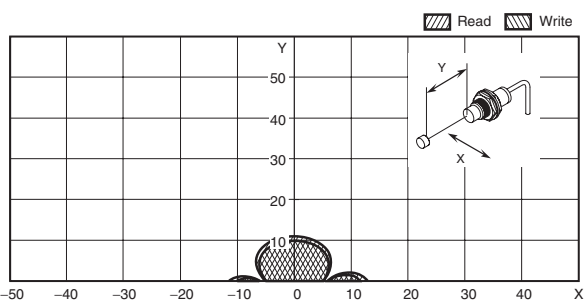

V680-HS51 (embedded in metallic material) & V680-D1KP52MT (embedded in metallic surface: steel)

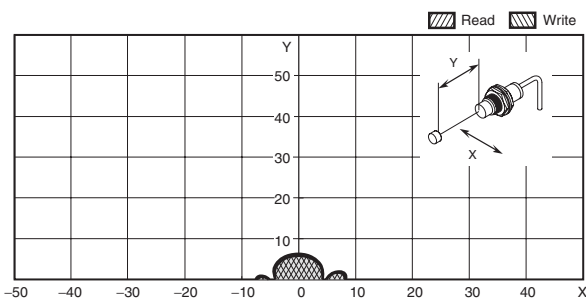

V680-HS63 (mounted on non-metallic material) & V680-D1KP52MT (embedded in non-metallic material)

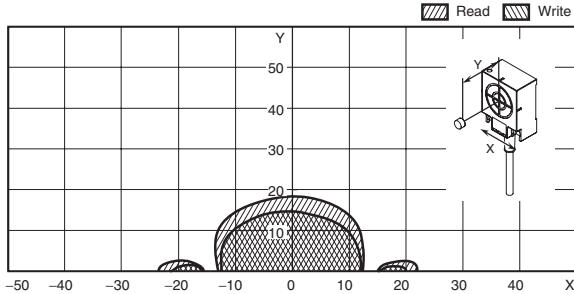

V680-HS51 (embedded in metallic material) & V680-D1KP53M (embedded in non-metallic material)

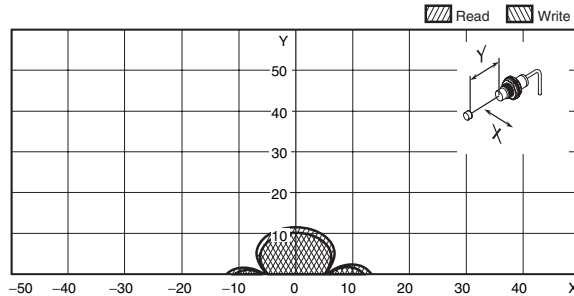

V680-HS51 (embedded in metallic material) & V680-D1KP53M (embedded in metallic surface: steel)

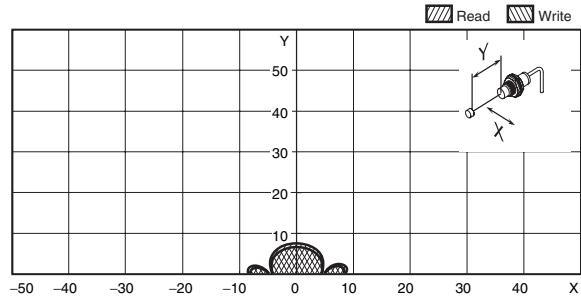

V680-HS52 (embedded in non-metallic material) & V680-D1KP53M (embedded in non-metallic material)

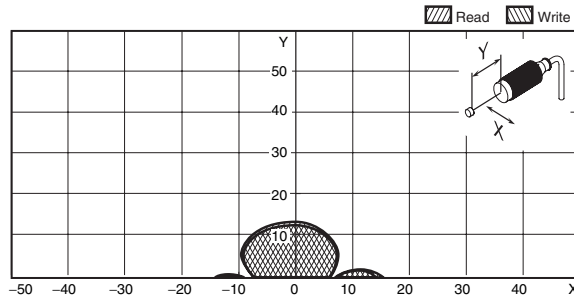

V680-HS52 (embedded in non-metallic material) & V680-D1KP53M (embedded in metallic surface: steel)

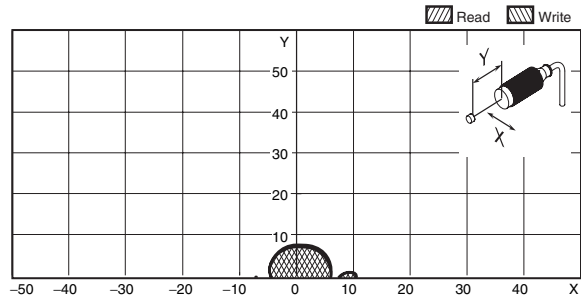

V680-HS52 (embedded in non-metallic material) & V680-D1KP54T (mounted on non-metallic material)

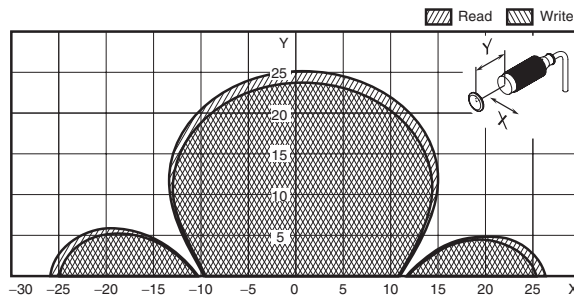

V680-HS63 (mounted on non-metallic material) & V680-D1KP54T (mounted on non-metallic material)

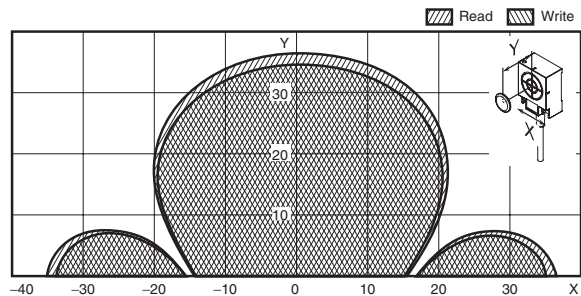

V680-HS65 (mounted on metallic material) & V680-D1KP54T (mounted on non-metallic material)

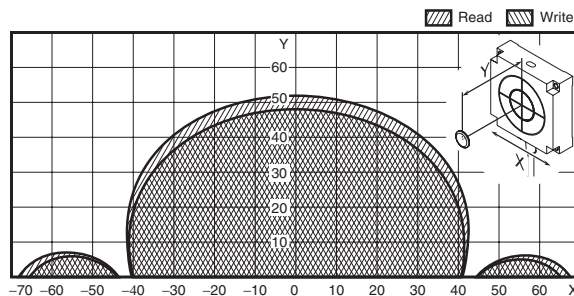

V680-HS52 (embedded in non-metallic material) & V680-D1KP66T (mounted on non-metallic material)

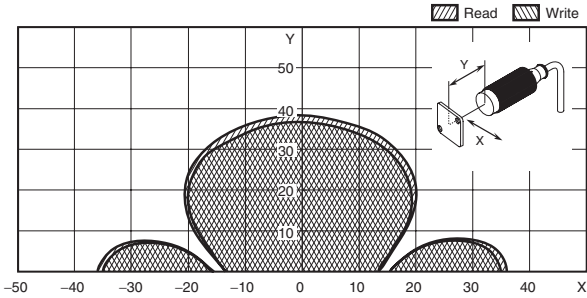

V680-HS63 (mounted on non-metallic material) & V680-D1KP66T (mounted on non-metallic material)

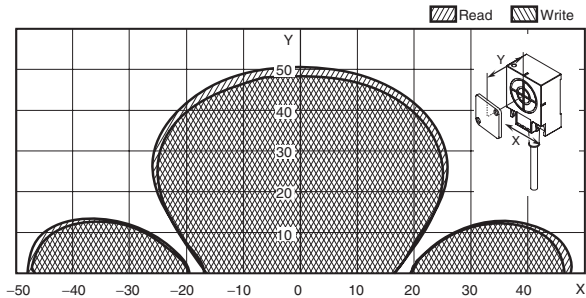

V680-HS65 (mounted on metallic material) & V680-D1KP66T (mounted on non-metallic material)

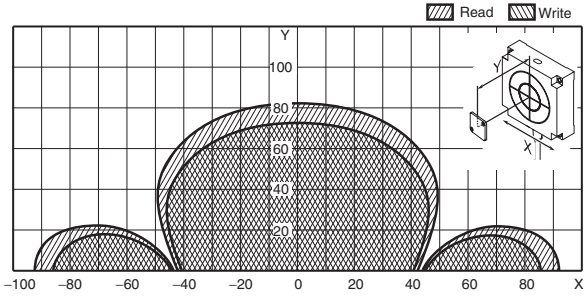

V680-H01-V2 (mounted on non-metallic material) & V680-D1KP66T (mounted on non-metallic material)

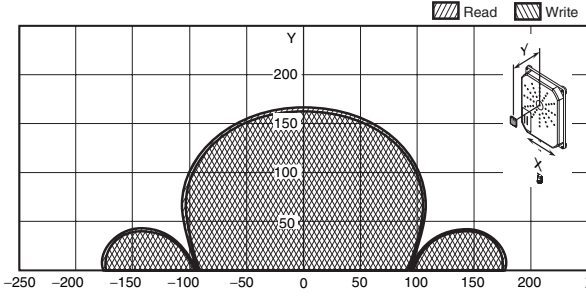

V680-HS52 (embedded in non-metallic material) & V680-D1KP66T-SP (embedded in non-metallic material)

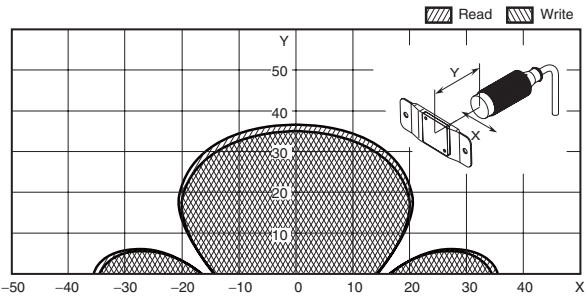

V680-HS63 (mounted on non-metallic material) & V680-D1KP66T-SP (mounted on non-metallic material)

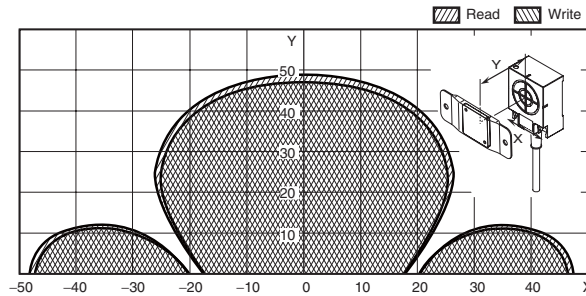

V680-HS65 (mounted on metallic material) & V680-D1KP66T-SP (mounted on non-metallic material)

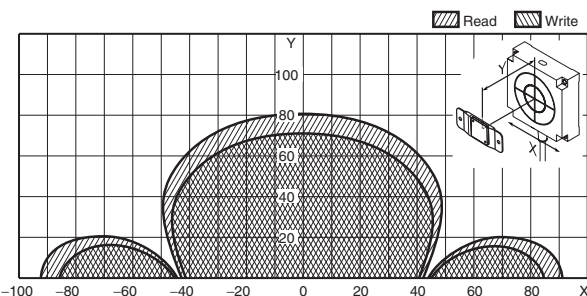

V680-HS52 (embedded in non-metallic material) & V680-D1KP66MT (mounted on metallic surface: steel)

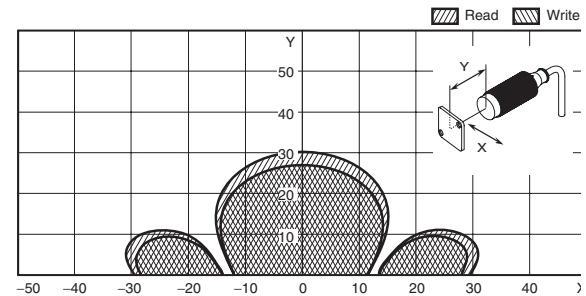

V680-HS63 (mounted on non-metallic material) & V680-D1KP66MT (mounted on metallic surface: steel)

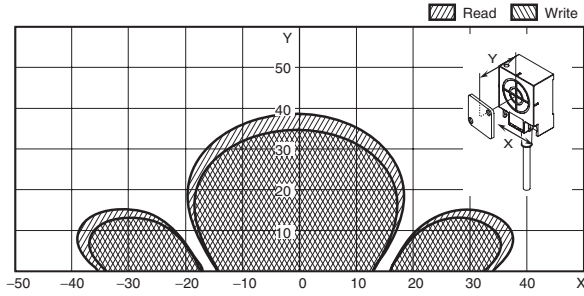

V680-HS65 (mounted on metallic material) & V680-D1K66MT (mounted on metallic surface: steel)

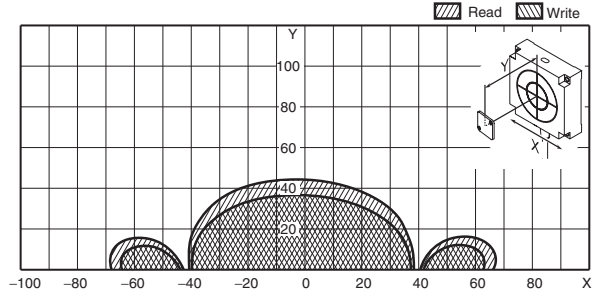

V680-H01-V2 (mounted on non-metallic material) & V680-D1KP58HT (mounted on non-metallic material)

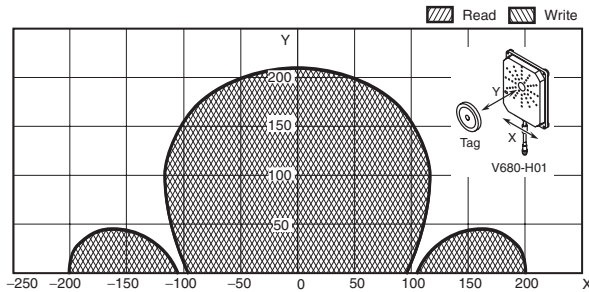

2-kbyte Memory ID Tag

The values given for communications ranges are reference values. Refer to pages 21 to 22 for communications distance specifications. The communications distance will depend on the ID Tags, ambient temperature, surrounding metal, noise, and other factors. Test operation completely when installing a system.

V680-HS52 (embedded in non-metallic material) & V680-D2KF52M (embedded in non-metallic material)

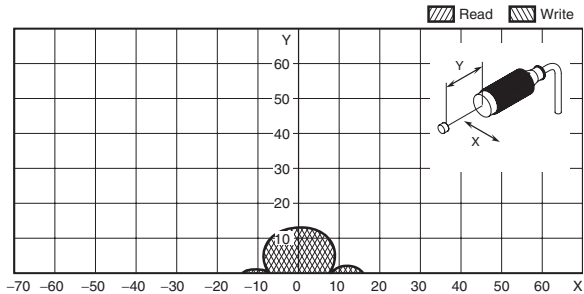

V680-HS52 (embedded in non-metallic material) & V680-D2KF52M (embedded in metallic surface: steel)

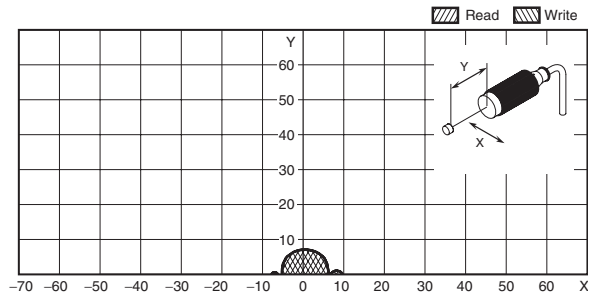

V680-HS51 (embedded in metallic material) & V680-D2KF52M (embedded in non-metallic material)

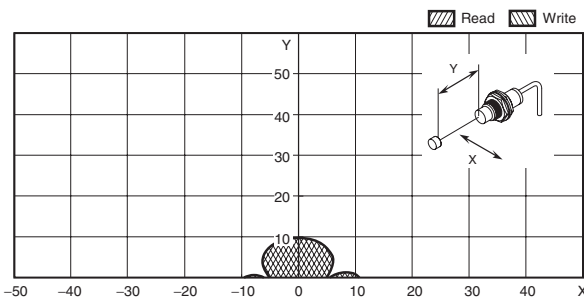

V680-HS51 (embedded in metallic material) & V680-D2KF52M (embedded in metallic surface: steel)

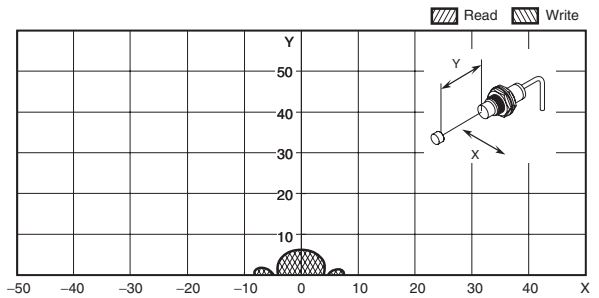

V680-HS63 (mounted on non-metallic material) & V680-D2KF52M (embedded in non-metallic material)

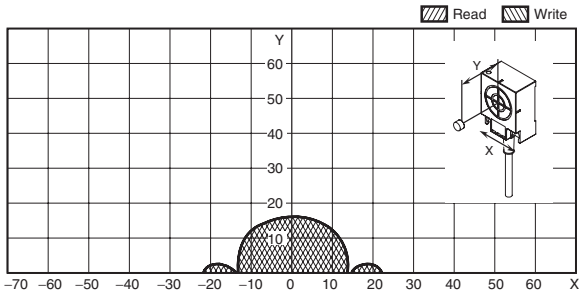

V680-HS63 (mounted on non-metallic material) & V680-D2KF67 (mounted on non-metallic material)

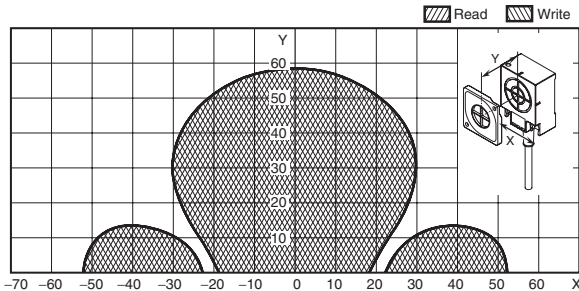

V680-H01-V2 (mounted on non-metallic material) & V680-D2KF67 (mounted on non-metallic material)

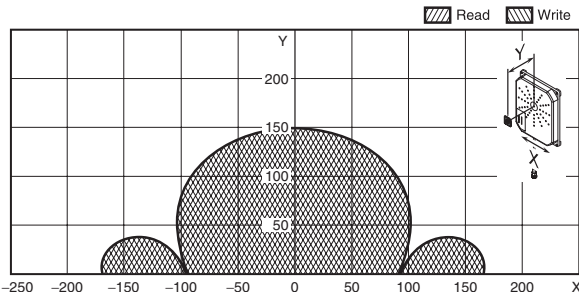

V680-HS63 (mounted on non-metallic material) & V680-D2KF67M (mounted on metallic surface: steel)

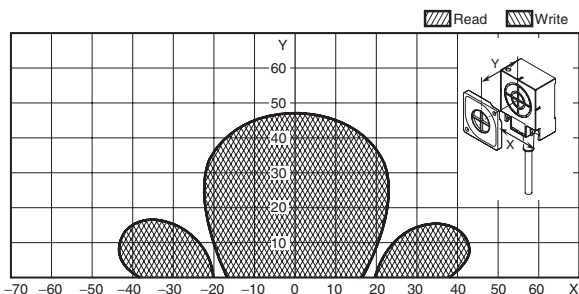

V680-HS52 (embedded in metallic material) & V680-D2KF67 (mounted on non-metallic material)

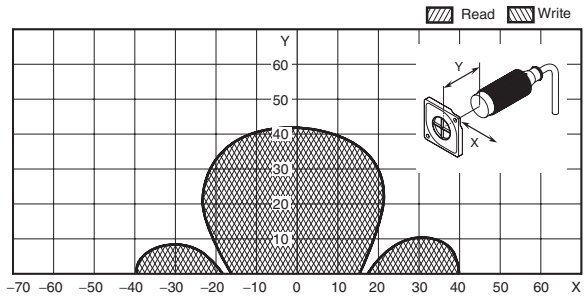

V680-HS65 (mounted on metallic material) & V680-D2KF67 (mounted on non-metallic material)

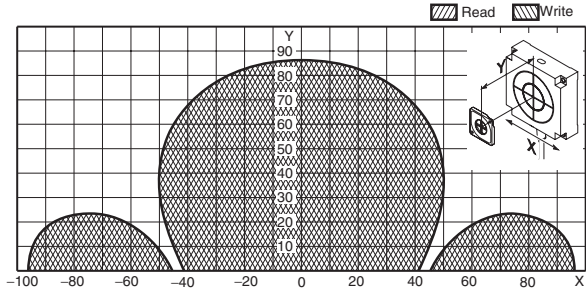

V680-HS52 (embedded in non-metallic material) & V680-D2KF67M (mounted on metallic surface: steel)

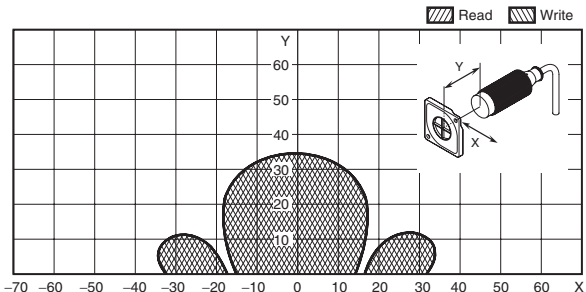

V680-HS65 (mounted on metallic material) & V680-D2KF67M (mounted on metallic surface: steel)

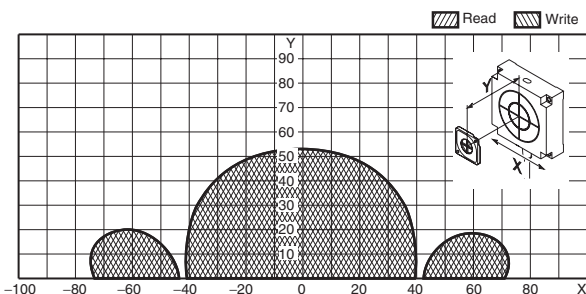

8-/32-kbyte Memory ID Tag

The values given for communications ranges are reference values. Refer to page 22 to 24 for communications distance specifications. The communications distance will depend on the ID Tags, ambient temperature, surrounding metal, noise, and other factors. Test operation completely when installing a system.

V680-HS52 (embedded in non-metallic material) & V680-D8KF67 (mounted on non-metallic material)

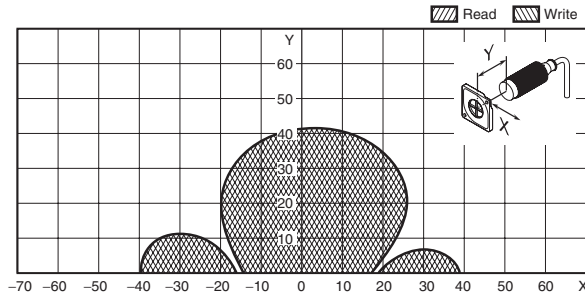

V680-HS63 (mounted on non-metallic material) & V680-D8KF67 (mounted on non-metallic material)

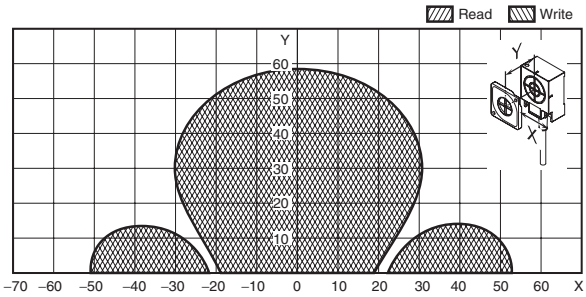

V680-HS65 (mounted on metallic material) & V680-D8KF67 (mounted on non-metallic material)

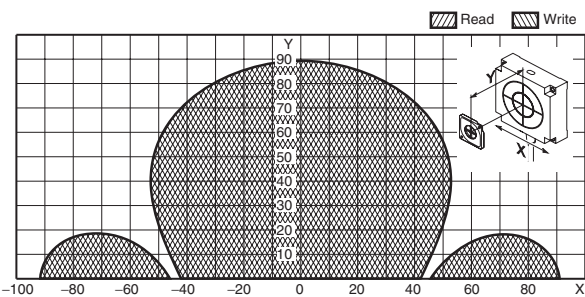

V680-H01-V2 (mounted on non-metallic material) & V680-D8KF67 (mounted on non-metallic material)

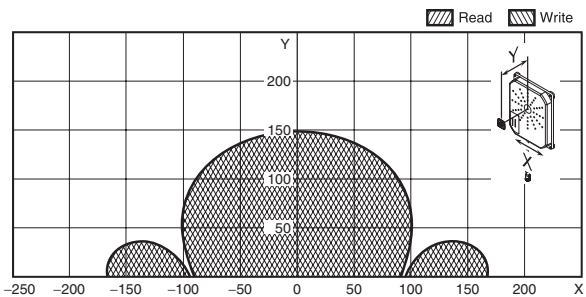

V680-HS52 (embedded in non-metallic material) & V680-D8KF67M (mounted on metallic surface: steel)

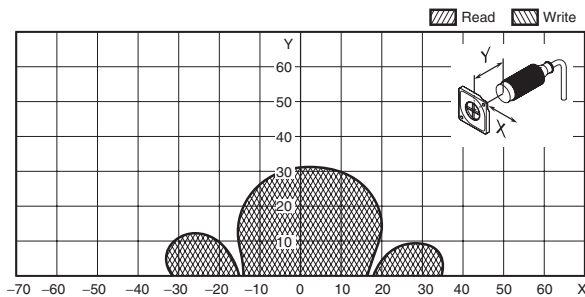

V680-HS63 (mounted on non-metallic material) & V680-D8KF67M (mounted on metallic surface: steel)

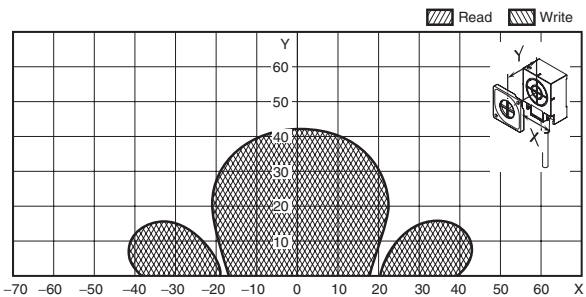

V680-HS65 (mounted on metallic material) & V680-D8KF67M (mounted on metallic surface: steel)

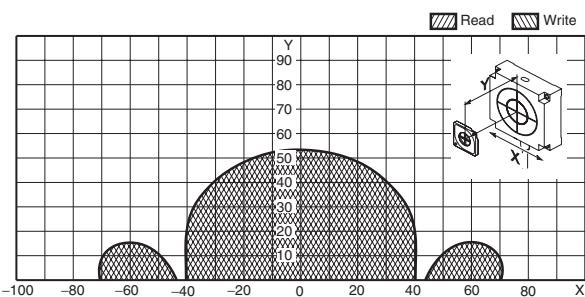

V680-HS63 (mounted on metallic material) & V680-D8KF68/-D32KF68 (mounted on non-metallic material) (Horizontal-facing ID Tag)

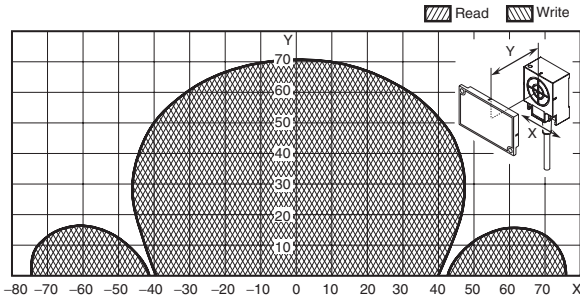

V680-HS63 (mounted on metallic material) & V680-D8KF68/-D32KF68 (mounted on non-metallic material) (Vertical-facing ID Tag)

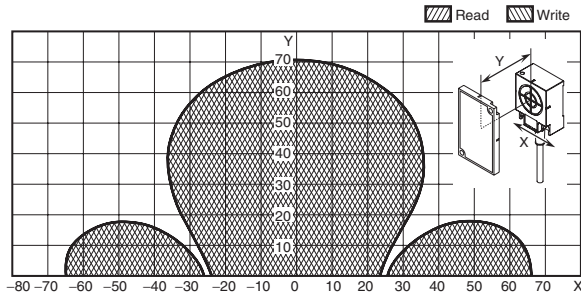

V680-HS63 (mounted on metallic material) & V680-D8KF68/-D32KF68 Mounted on metallic surface: steel (Horizontal-facing ID Tag) When the V680-A81 ID Tag Attachment is mounted.

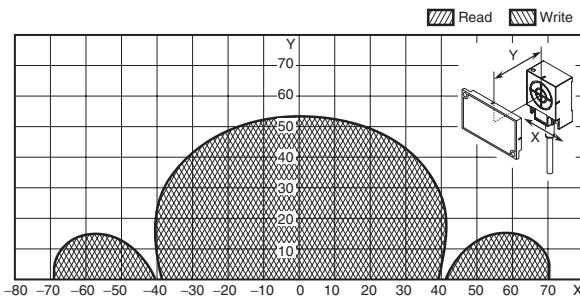

V680-HS63 (mounted on metallic material) & V680-D8KF68/-D32KF68 Mounted on metallic surface: steel (Vertical-facing ID Tag) When the V680-A81 ID Tag Attachment is mounted.

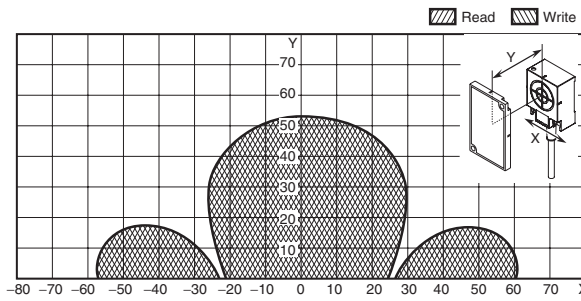

V680-HS65 (mounted on metallic material) & V680-D8KF68/-D32KF68 (Horizontal-facing ID Tag)

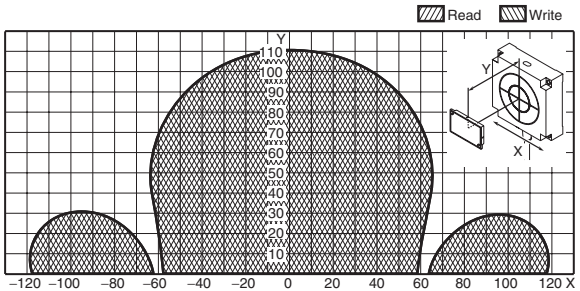

V680-HS65 (mounted on metallic material) & V680-D8KF68/-D32KF68 (Vertical-facing ID Tag)

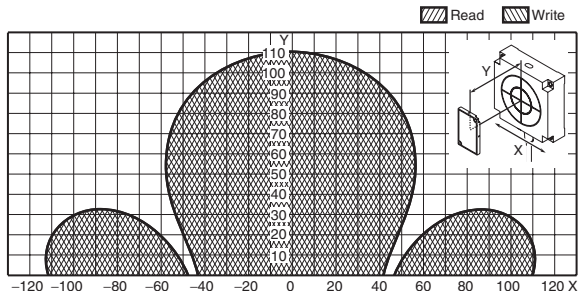

V680-HS65 (mounted on metallic material) & V680-D8KF68/-D32KF68 Flush-mounted on metallic surface: steel (Horizontal-facing ID Tag) When the V680-A81 ID Tag Attachment is mounted.

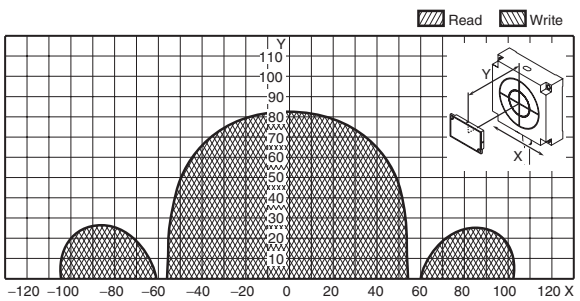

V680-HS65 (mounted on metallic material) & V680-D8KF68/-D32KF68 Flush-mounted on metallic surface: steel (Vertical-facing ID Tag) When the V680-A81 ID Tag Attachment is mounted.

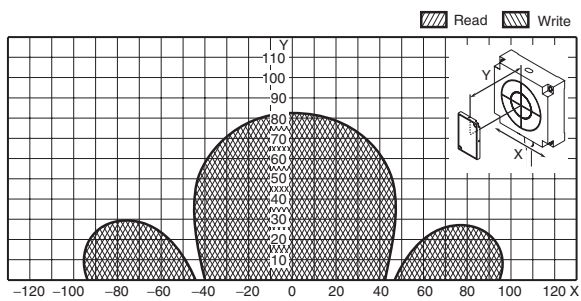

V680-H01-V2 (mounted on non-metallic material) & V680-D8KF68/-D32KF68 (Horizontal-facing ID Tag)

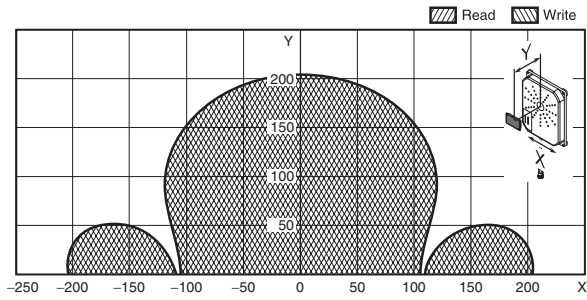

V680-H01-V2 (mounted on non-metallic material) & V680-D8KF68/-32KF68 (Vertical-facing ID Tag)

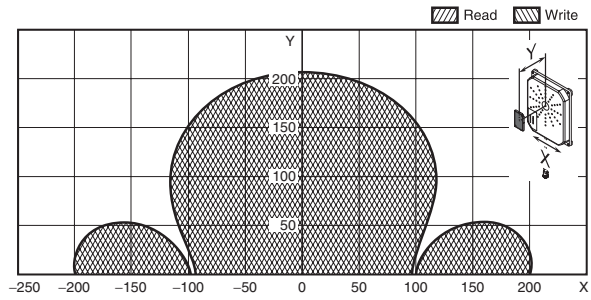

Communications Time

Communications Time between Antennas and Tags

1-kbyte Memory ID Tag

V680-D1KP□ (used in combination with the V680-HS□□ Read/Write Antenna and V680-HA63A Amplifier Unit)
 V680-D1KP58HT (used in combination with the V680-H01 Read/Write Antenna)

● Transmission speed: Normal mode

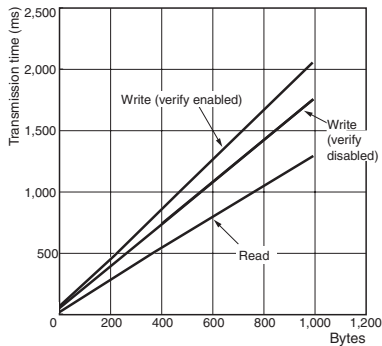

● Transmission speed: High-speed mode

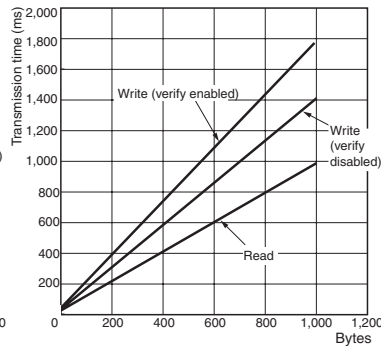

Controller or ID Sensor Unit transmission speed setting	Command	Write verification setting	Transmission time (ms) N = Number of processing bytes
Normal mode	Read	---	$T = 1.3N + 31$
	Write	Enabled	$T = 2.1N + 58$
Disabled		$T = 1.8N + 56$	
High-speed mode (See notes 1 and 2.)	Read	---	$T = 1.0N + 29$
	Write	Enabled	$T = 1.8N + 51$
Disabled		$T = 1.5N + 47$	

Note 1. The V680-H01 Read/Write Antenna cannot be used in high-speed mode.

2. When multi-access or FIFO is selected as the transmission option, the transmission time will be the same as in normal mode even when the transmission speed is set to high-speed mode.

2-kbyte Memory ID Tag

V680-D2KF□□ (used in combination with the V680-HS□□ Read/Write Antenna and V680-HA63B Amplifier Unit)

● Transmission speed: Normal mode

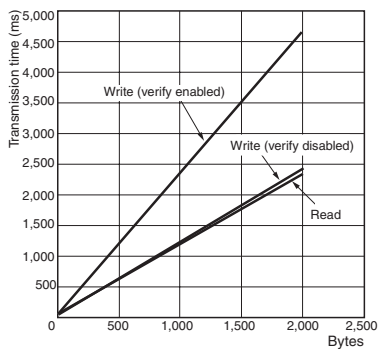

● Transmission speed: High-speed mode

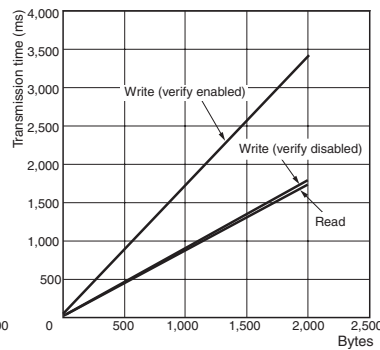

Controller or ID Sensor Unit transmission speed setting	Command	Write verification setting	Transmission time (ms) N = Number of processing bytes
Normal mode	Read	---	$T = 1.2N + 30$
	Write	Enabled	$T = 2.4N + 49$
Disabled		$T = 1.2N + 49$	
High-speed mode (See note.)	Read	---	$T = 0.9N + 27$
	Write	Enabled	$T = 1.7N + 49$
Disabled		$T = 0.9N + 41$	

Note: When multi-access or FIFO is selected as the transmission option, the transmission time will be the same as in normal mode even when the transmission speed is set to high-speed mode.

8-/32-kbyte Memory ID Tag

V680-D8KF□□, V680-D32KF□□ (used in combination with the V680-HS□□ Read/Write Antenna and V680-HA63B Amplifier Unit)

● Transmission speed: Normal mode

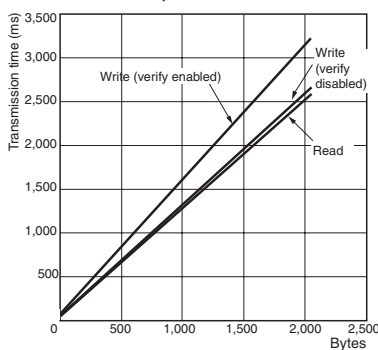

● Transmission speed: High-speed mode

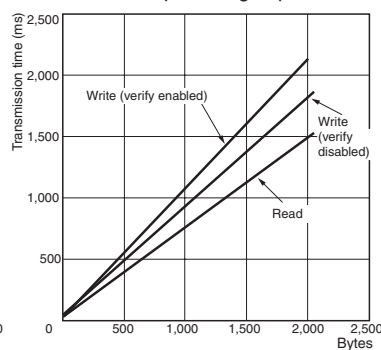

Controller or ID Sensor Unit transmission speed setting	Command	Write verification setting	Transmission time (ms) N = Number of processing bytes
Normal mode	Read	---	$T = 1.3N + 30$
	Write	Enabled	$T = 1.6N + 59$
Disabled		$T = 1.3N + 50$	
High-speed mode (See note.)	Read	---	$T = 0.8N + 25$
	Write	Enabled	$T = 1.1N + 41$
Disabled		$T = 0.9N + 40$	

Note: When multi-access or FIFO is selected as the transmission option, the transmission time will be the same as in normal mode even when the transmission speed is set to high-speed mode.

TAT When Using an ID Controller (Reference Values)

TAT (Turn Around Time)

TAT refers to the total time required from the point at which a host device (such as a personal computer) starts sending a command until a response is received.

TAT = Command send time + ID Tag transmission time + response receipt time

Command send time: This is the time required for sending a command from the host device to the Controller.
It varies depending on the communications speed and format.

ID Tag transmission time: This is the time required for transmission between the Read/Write Antenna and the ID Tag.

Response receipt time: This is the time required for returning a response from the Controller to the host device.
It varies depending on the communications speed and format.

For an ordinary command

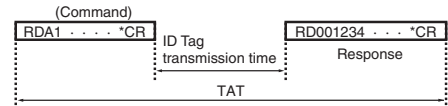

1-kbyte Memory ID Tag

V680-D1KP□ (used in combination with the V680-HS□□ Read/Write Antenna and V680-HA63A Amplifier Unit)

V680-D1KP58HT (used in combination with the V680-H01 Read/Write Antenna)

Controller or ID Sensor Unit transmission speed setting	Command	Write verification setting	Number of bytes to processed (byte)	TAT (ms) (See note 1.)	
Normal mode	Read	---	100	173	
			256	389	
			512	747	
			1,000	1,431	
	Write	Enabled	Enabled	100	280
				256	621
				512	1,184
				1,000	2,258
		Disabled	Disabled	100	248
				256	542
512				1,028	
1,000				1,956	
High-speed mode (See notes 2 and 3.)	Read	---	100	141	
			256	310	
			512	591	
			1,000	1,129	
	Write	Enabled	Enabled	100	243
				256	537
				512	1,023
				1,000	1,951
		Disabled	Disabled	100	209
				256	456
			512	865	
			1,000	1,647	

- Note 1.** These are the TAT values for a baud rate of 115,200 bps. For information on the TAT for baud rates other than 115,200 bps, refer to the *User's Manual*.
- The V680-H01 Read/Write Antenna cannot be used in high-speed mode.
 - When multi-access or FIFO is selected as the transmission option, the transmission time will be the same as in normal mode even when the transmission speed is set to high-speed mode.
 - The value given for TAT data assumes that communications settings for the V680-CA5D01/02-V2 ID Controller are as follows:
Data length: 8 bits, Stop bits: 1, Parity: Odd.
In this example, communications are continuous, with no gaps between characters.
 - The number of bytes of TAT data is the number of bytes when ASCII is specified as the code.

2-kbyte Memory ID Tag

V680-D2KF□□ (used in combination with the V680-HS□□ Read/Write Antenna and V680-HA63B Amplifier Unit)

Controller or ID Sensor Unit transmission speed setting	Command	Write verification setting	Number of bytes to processed (byte)	TAT (ms) (See note 1.)	
Normal mode	Read	---	100	162	
			256	363	
			512	695	
			1,000	1,330	
			2,000	2,620	
	Write	Enabled		100	301
				256	689
				512	1,328
				1,000	2,549
				2,000	5,039
		Disabled		100	181
				256	382
				512	714
				1,000	1,349
2,000	2,639				
High-speed mode (See note 2.)	Read	---	100	132	
			256	286	
			512	541	
			1,000	1,030	
			2,000	2,020	
	Write	Enabled		100	231
				256	510
				512	970
				1,000	1,849
				2,000	3,639
		Disabled		100	143
				256	297
				512	552
				1,000	1,041
2,000	2,031				

Note 1. These are the TAT values for a baud rate of 115,200 bps. For information on the TAT for baud rates other than 115,200 bps, refer to the *User's Manual*.

2. When multi-access or FIFO is selected as the transmission option, the transmission time will be the same as in normal mode even when the transmission speed is set to high-speed mode.
3. The value given for TAT data assumes that communications settings for the V680-CA5D01/02-V2 ID Controller are as follows:
Data length: 8 bits, Stop bits: 1, Parity: Odd.
In this example, communications are continuous, with no gaps between characters.
4. The number of bytes of TAT data is the number of bytes when ASCII is specified as the code.

8-/32-kbyte Memory ID Tag

V680-D8KF□□, V680-D32KF□□ (used in combination with the V680-HS□□ Read/Write Antenna and V680-HA63B Amplifier Unit)

Controller or ID Sensor Unit transmission speed setting	Command	Write verification setting	Number of bytes to processed (byte)	TAT (ms) (See note 1.)	
Normal mode	Read	---	100	172	
			256	388	
			512	746	
			1,000	1,430	
			2,000	2,820	
	Write	Yes	---	100	231
				256	494
				512	929
				1,000	1,759
				2,000	3,449
		No	---	100	192
				256	408
				512	766
				1,000	1,450
2,000	2,840				
High-speed mode (See note 2.)	Read	---	100	117	
			256	255	
			512	485	
			1,000	925	
			2,000	1,815	
	Write	Yes	---	100	163
				256	348
				512	655
				1,000	1,241
				2,000	2,431
		No	---	100	142
				256	296
				512	551
				1,000	1,040
2,000	2,030				

- Note 1.** These are the TAT values for a baud rate of 115,200 bps. For information on the TAT for baud rates other than 115,200 bps, refer to the *User's Manual*.
- 2.** When multi-access or FIFO is selected as the transmission option, the transmission time will be the same as in normal mode even when the transmission speed is set to high-speed mode.
- 3.** The value given for TAT data assumes that communications settings for the V680-CA5D01/02-V2 ID Controller are as follows:
Data length: 8 bits, Stop bits: 1, Parity: Odd.
In this example, communications are continuous, with no gaps between characters.
- 4.** The number of bytes of TAT data is the number of bytes when ASCII is specified as the code.

Safety Precautions

WARNING

Do not use this product as a detection device to protect people.



Note: This catalog is intended only to help select the appropriate product. Be sure to read the User's Manual for usage precautions prior to using the product.

Precautions for Safe Use

To ensure safety, be sure to follow the following precautions:

1. Do not operate this product in any flammable, explosive, or corrosive gas environment.
2. Do not disassemble, repair, or remodel this product.
3. Tighten the base lock screws and terminal block screws completely.
4. Be sure to use wiring crimp terminals of the specified size.
5. If any cable has a locking mechanism, be sure to check that it has been locked before using it.
6. The DC power supply must be within the specified rating (24 VDC +10%/–15%).
7. Do not reverse the power supply connection.
8. Do not insert water, wire, etc., into any of the gaps in the case. Doing so may cause fire or electric shock.
9. Turn OFF the Controller or ID Sensor Unit power before attaching or removing the Read/Write Antenna.
10. In the event that the product exhibits any abnormal condition, immediately stop using the system, turn OFF the power, and contact your OMRON sales representative.
11. Dispose of this product as industrial waste.
12. Be sure to follow any other warnings, cautions, and notices given in this document.

Precautions for Correct Use

Please observe the following precautions to prevent failure to operate, malfunctions, or undesirable effects on product performance.

Installation Site

Install the product at a location where:

- It is not exposed to corrosive gases, dust, metal chips, or salt.
- The ambient operating temperature is within the range stipulated in the specifications.
- There are no sudden variations in temperature (no condensation).
- The ambient operating humidity is within the range stipulated in the specifications.
- No vibration or shock exceeding the values stipulated in the specifications is transmitted directly to the body of the product.
- It is not subject to splashing water, oil, or chemical substances.

Installation

- The product uses the 13.56-MHz frequency band to communicate with ID Tags. Some devices, such as some motors, inverters, and switching power supplies, generate electromagnetic waves (i.e., noise) that can affect communications with ID Tags. If any of these devices are nearby, communications with ID Tags may be affected or ID Tags may be destroyed. If the product is to be used near such devices, check the effects on communications before using the product.
- To minimize the general influence of noise, observe the following precautions:
 1. Ground any metallic material located around this device to 100 Ω or less.
 2. Keep the product away from high voltage and heavy current.
- Do not use products that are not waterproof in misty environments.

- Do not subject the products to chemicals that adversely affect product materials.
- When installing the product, tighten screws to the following torque:

Controller:	1.2 N·m max.
ID Sensor Unit:	0.4 N·m
V680-HS51 Read/Write Antenna:	6 N·m
V680-HS52 Read/Write Antenna:	40 N·m
V680-HS63 Read/Write Antenna:	1.2 N·m
V680-HS65 Read/Write Antenna:	1.2 N·m

 (Attach the enclosed Mounting Brackets)

V680-D1KP66T/-D1KP66MT:	0.5 N·m
V680-D1KP66T-SP:	1.2 N·m
V680-D1KP54T:	0.3 to 0.5 N·m
V680-D2KF67/-D2KF67M:	0.6 N·m
V680-D8KF67/-D8KF67M:	0.6 N·m
V680-D8KF68/-D32KF68:	1.2 N·m
- When Read/Write Antennas are mounted side-by-side, mutual interference may reduce the transmission performance. Refer to the *RFID System Amplifier and Antennas/ID Tags User's Manual* to mount them in a way that will prevent mutual interference.

Storage

Store the product at a location where:

- It is not exposed to corrosive gases, dust, metal chips, or salt.
- The ambient storage temperature is within the range stipulated in the specifications.
- There are no sudden variations in temperature (no condensation).
- The ambient storage humidity is within the range stipulated in the specifications.
- No vibration or shock exceeding the values stipulated in the specifications is transmitted directly to the body of the product.
- It is not subject to splashing water, oil, or chemical substances.

Cleaning

Do not use thinner, benzene, acetone, or kerosene for cleaning. Using these substances may dissolve the resin material and the case.

Dimensions

Note: All units are in millimeters unless otherwise indicated.

ID Tag

V680-D1KP52MT/-D2KF52M



Case material	PPS resin
Filling	Epoxy resin

V680-D1KP53M

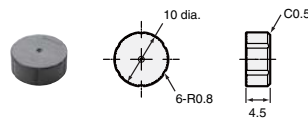

Case material	PPS resin
Filling	Epoxy resin

V680-D1KP54T

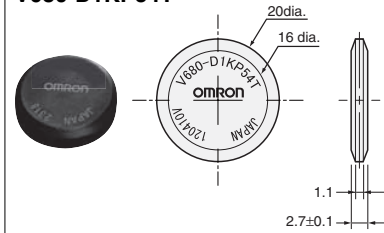

Case material	PPS resin
---------------	-----------

V680-D1KP66T/-D1KP66MT

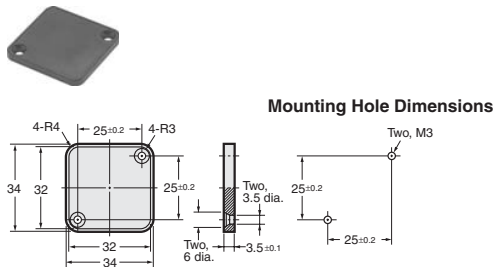

Case material	PPS resin
---------------	-----------

V680-D1KP66T-SP

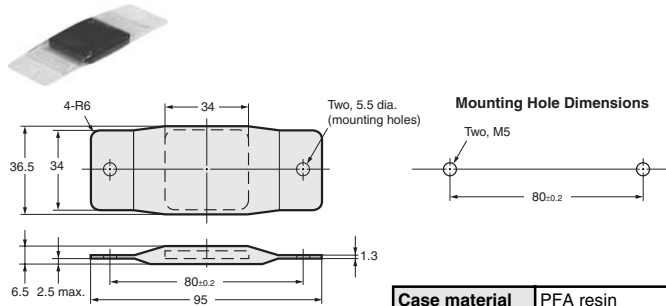

Case material	PFA resin
---------------	-----------

V680-D2KF67/-D2KF67M

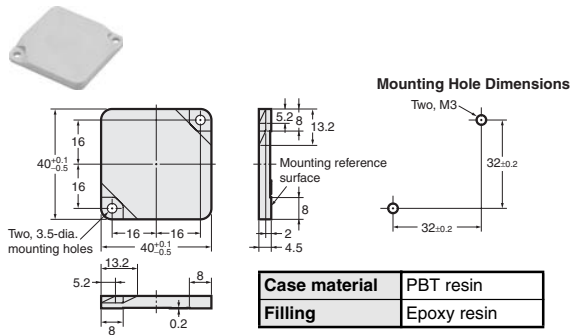

Case material	PBT resin
Filling	Epoxy resin

V680-D8KF67/-D8KF67M

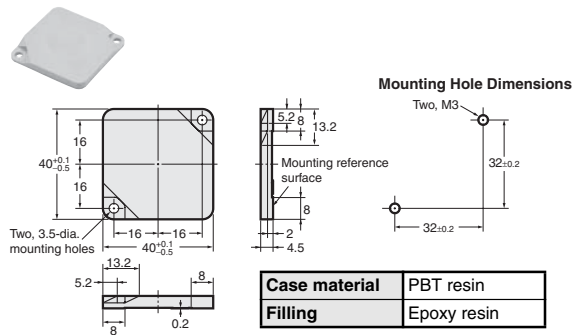

Case material	PBT resin
Filling	Epoxy resin

V680-D8KF68/-D32KF68

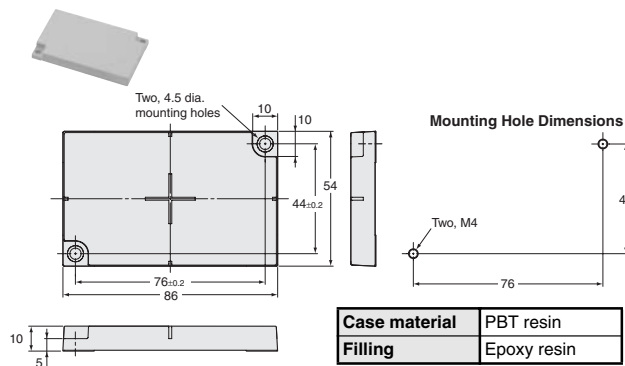

Case material	PBT resin
Filling	Epoxy resin

V680-D1KP58HT

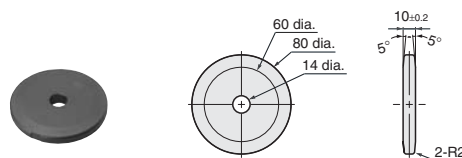

Coating	PPS resin
---------	-----------

Read/Write Antenna with Detachable Amplifier Unit

V680-HS52-W

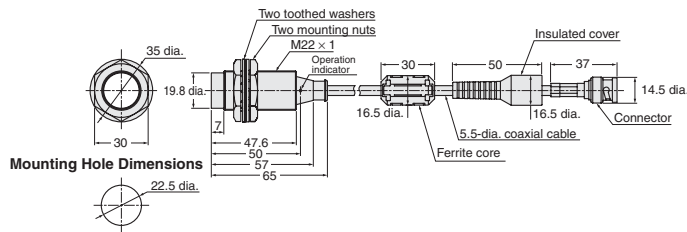

Case material	Brass
Transmission surface	PBT resin
Filling	Epoxy resin
Cable	PVC

V680-HS52-R

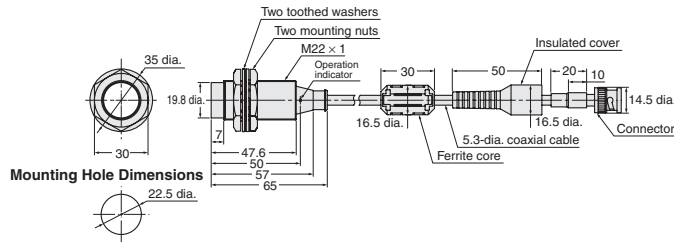

Case material	Brass
Transmission surface	PBT resin
Filling	Epoxy resin
Cable	PVC

V680-HS51

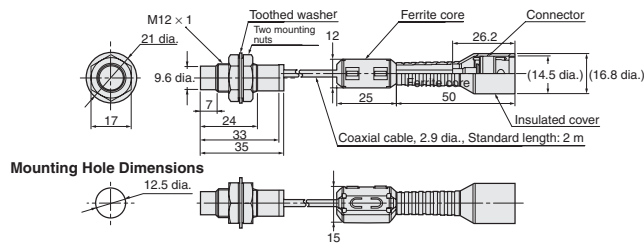

Case material	Brass
Transmission surface	ABS resin
Filling	Epoxy resin
Cable	PVC

V680-HS63-W

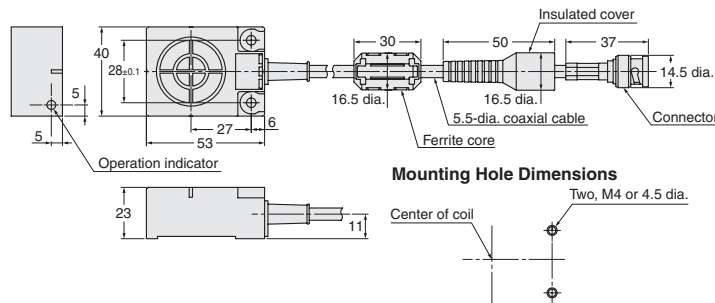

Case material	ABS resin
Filling	Epoxy resin
Cable	PVC

V680-HS63-R

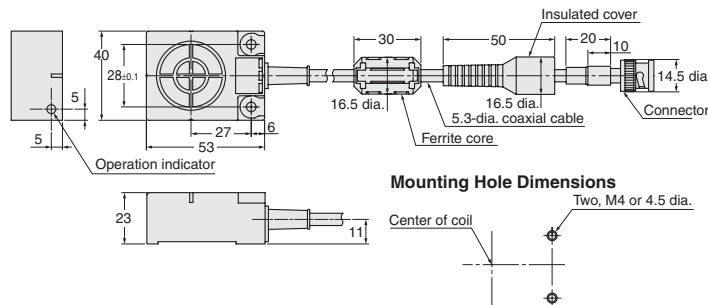

Case material	ABS resin
Filling	Epoxy resin
Cable	PVC

V680-HS65-W

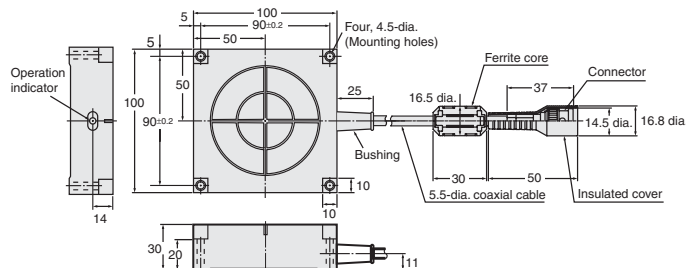

Case material	ABS resin
Filling	Epoxy resin
Cable	PVC (gray)

V680-HS65-R

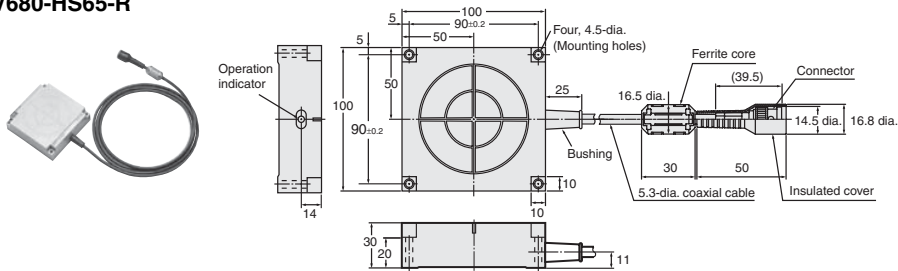

Case material	ABS resin
Filling	Epoxy resin
Cable	PVC (black)

Read/Write Antenna with Built-in Amplifier Unit

V680-H01-V2

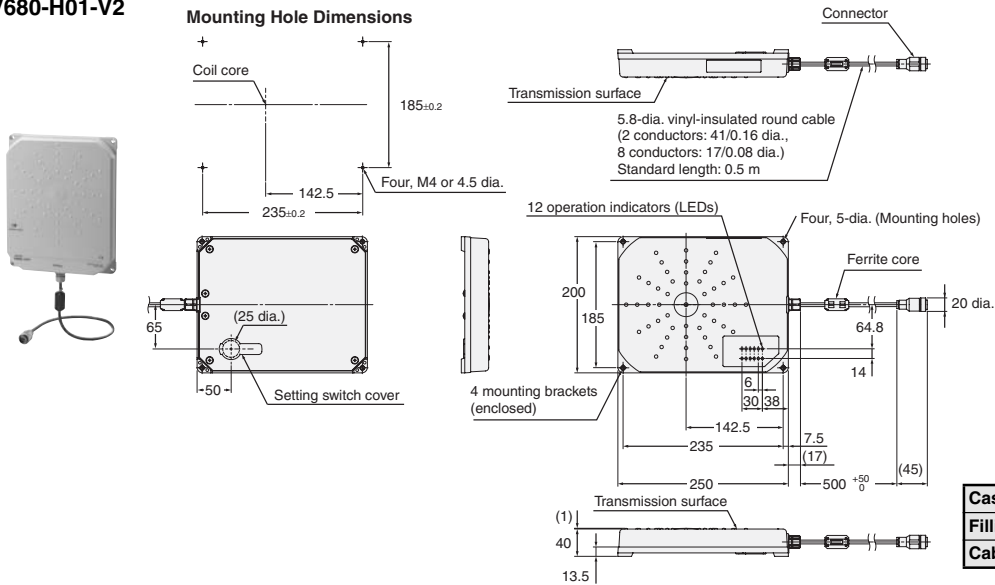

Case material	PC/ASA resin
Filling	Aluminum
Cable	PVC

Amplifier Unit

V680-HA63A/-HA63B

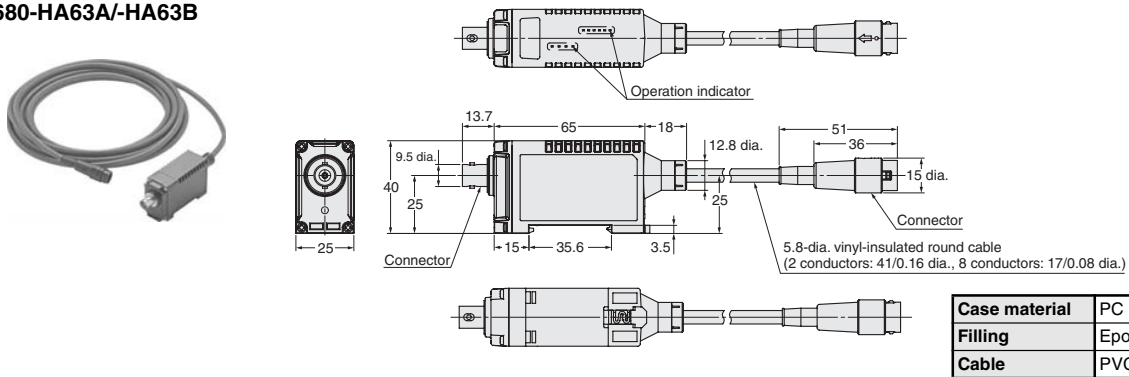

Case material	PC resin
Filling	Epoxy resin
Cable	PVC

ID Controller

V680-CA5D01-V2/-CA5D02-V2

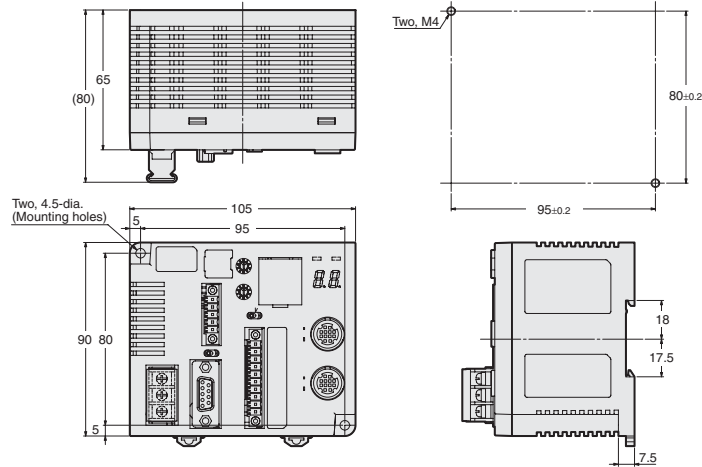

ID Sensor Units

CJ1W-V680C11

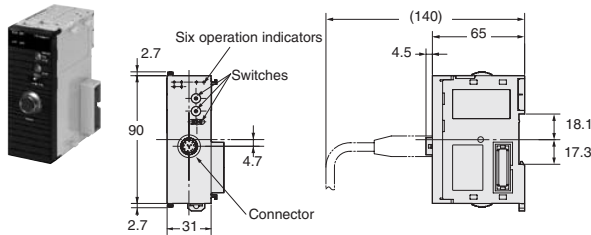

CS1W-V680C11

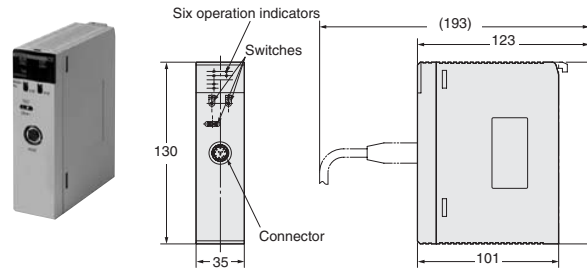

CJ1W-V680C12

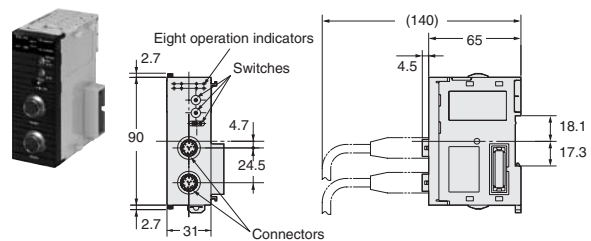

CS1W-V680C12

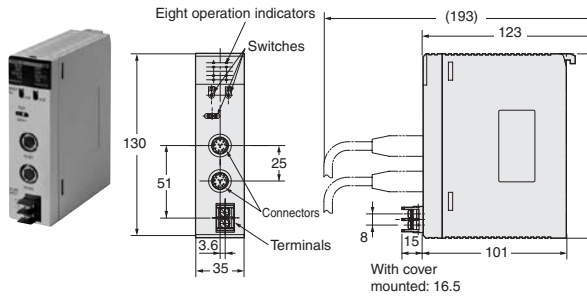

Handheld Reader Writer

V680-CHUD

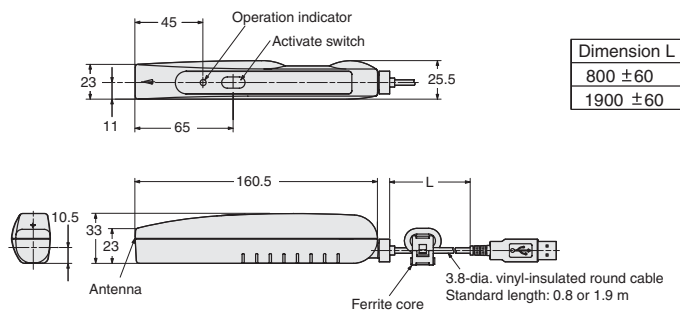

Case material	ABS resin
Nameplate material	PET resin

V680-CH1D

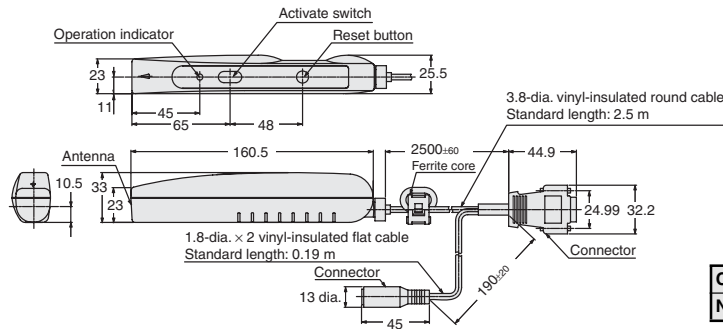

V680-CH1D-PSI

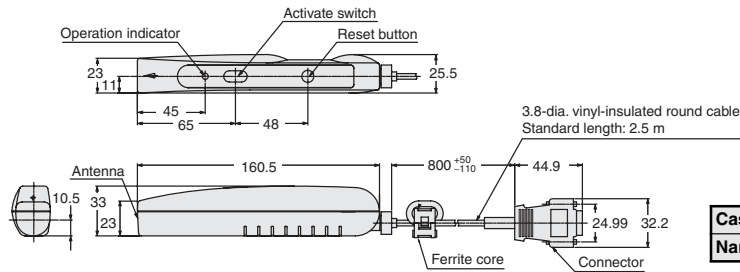

AC Adapter

V600-A22

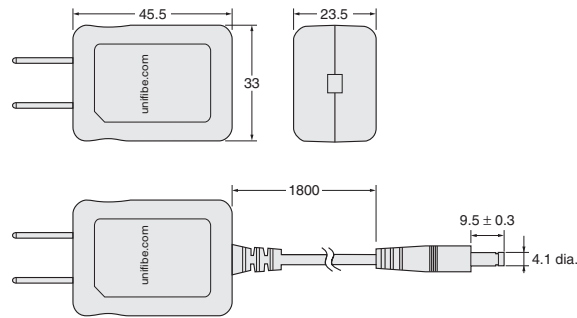
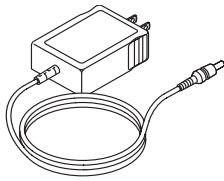

Handheld Terminal (Recommended)

Recommended Handheld Terminal
Psion Teklogix model 7527S-G2-□□-S
(V680-A-7527S-G2-□□-S)

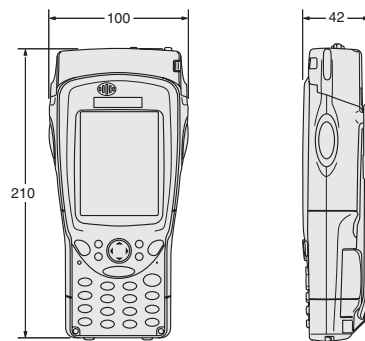

Accessories

**V680-D1KP66T Attachments
V600-A86 Holder**

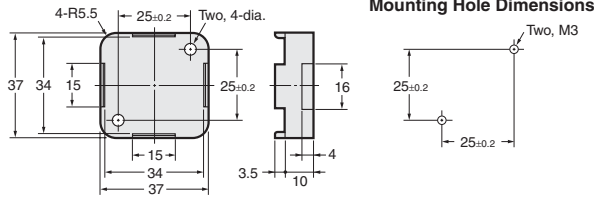

Case material	PPS resin
---------------	-----------

**V680-D8KF68/-D32KF68 Attachments
V600-A81 Holder**

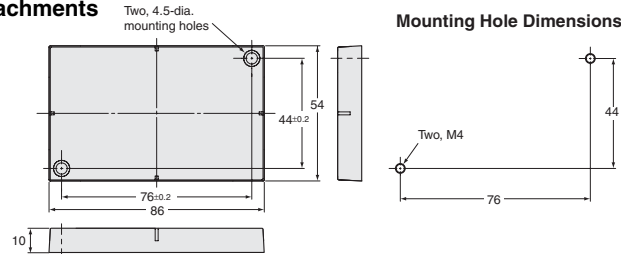

Case material	PBT resin
Filling	Epoxy resin

**V680-D1KP58HT Attachments
V680-A80**

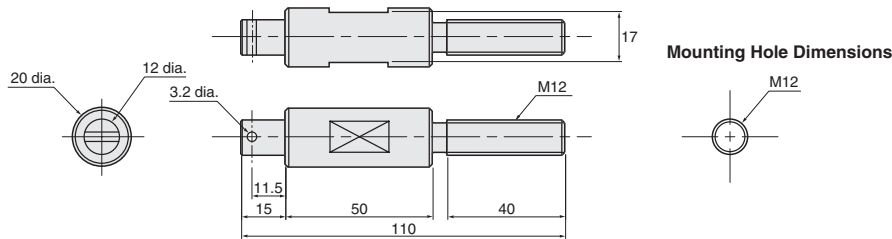

**V680-D1KP54T Attachments
V700-A80**

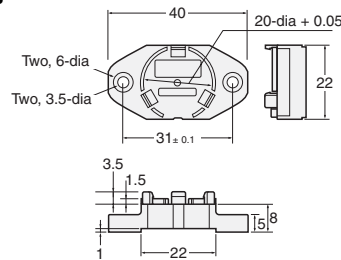

Amplifier Unit Special Extension Cable

- V700-A40 2M.
- V700-A41 3M.
- V700-A42 5M.
- V700-A43 10M.
- V700-A44 20M.
- V700-A45 30M.

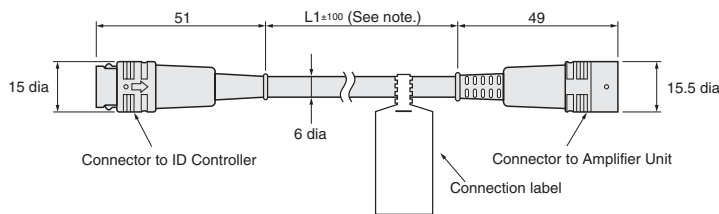

Note: The model numbers for each length (L1) are as follows:

Model	Length L1
V700-A40 2M.	2,000
V700-A41 3M.	3,000
V700-A42 5M.	5,000
V700-A43 10M.	10,000
V700-A44 20M.	20,000
V700-A45 30M.	30,000

Material	PVC
----------	-----

V680-H01 Special Cables

- V700-A40-W 2M
- V700-A40-W 5M
- V700-A40-W 10M
- V700-A40-W 20M
- V700-A40-W 30M

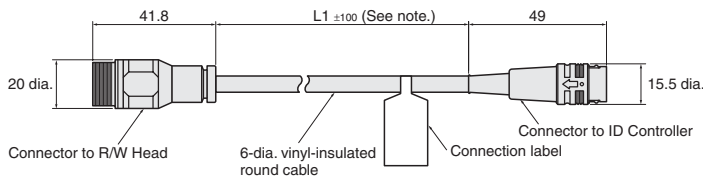

Note: The model numbers for each length (L1) are as follows:

Model	Length L1
V700-A40-W 2M	2,000
V700-A40-W 5M	5,000
V700-A40-W 10M	10,000
V700-A40-W 20M	20,000
V700-A40-W 30M	30,000

Material	PVC
----------	-----

ALL DIMENSIONS SHOWN ARE IN MILLIMETERS.

To convert millimeters into inches, multiply by 0.03937. To convert grams into ounces, multiply by 0.03527.

Terms and Conditions of Sale

1. **Offer; Acceptance.** These terms and conditions (these "Terms") are deemed part of all quotes, agreements, purchase orders, acknowledgments, price lists, catalogs, manuals, brochures and other documents, whether electronic or in writing, relating to the sale of products or services (collectively, the "Products") by Omron Electronics LLC and its subsidiary companies ("Omron"). Omron objects to any terms or conditions proposed in Buyer's purchase order or other documents which are inconsistent with, or in addition to, these Terms.
2. **Prices; Payment Terms.** All prices stated are current, subject to change without notice by Omron. Omron reserves the right to increase or decrease prices on any unshipped portions of outstanding orders. Payments for Products are due net 30 days unless otherwise stated in the invoice.
3. **Discounts.** Cash discounts, if any, will apply only on the net amount of invoices sent to Buyer after deducting transportation charges, taxes and duties, and will be allowed only if (i) the invoice is paid according to Omron's payment terms and (ii) Buyer has no past due amounts.
4. **Interest.** Omron, at its option, may charge Buyer 1-1/2% interest per month or the maximum legal rate, whichever is less, on any balance not paid within the stated terms.
5. **Orders.** Omron will accept no order less than \$200 net billing.
6. **Governmental Approvals.** Buyer shall be responsible for, and shall bear all costs involved in, obtaining any government approvals required for the importation or sale of the Products.
7. **Taxes.** All taxes, duties and other governmental charges (other than general real property and income taxes), including any interest or penalties thereon, imposed directly or indirectly on Omron or required to be collected directly or indirectly by Omron for the manufacture, production, sale, delivery, importation, consumption or use of the Products sold hereunder (including customs duties and sales, excise, use, turnover and license taxes) shall be charged to and remitted by Buyer to Omron.
8. **Financial.** If the financial position of Buyer at any time becomes unsatisfactory to Omron, Omron reserves the right to stop shipments or require satisfactory security or payment in advance. If Buyer fails to make payment or otherwise comply with these Terms or any related agreement, Omron may (without liability and in addition to other remedies) cancel any unshipped portion of Products sold hereunder and stop any Products in transit until Buyer pays all amounts, including amounts payable hereunder, whether or not then due, which are owing to it by Buyer. Buyer shall in any event remain liable for all unpaid accounts.
9. **Cancellation; Etc.** Orders are not subject to rescheduling or cancellation unless Buyer indemnifies Omron against all related costs or expenses.
10. **Force Majeure.** Omron shall not be liable for any delay or failure in delivery resulting from causes beyond its control, including earthquakes, fires, floods, strikes or other labor disputes, shortage of labor or materials, accidents to machinery, acts of sabotage, riots, delay in or lack of transportation or the requirements of any government authority.
11. **Shipping; Delivery.** Unless otherwise expressly agreed in writing by Omron:
 - a. Shipments shall be by a carrier selected by Omron; Omron will not drop ship except in "break down" situations.
 - b. Such carrier shall act as the agent of Buyer and delivery to such carrier shall constitute delivery to Buyer;
 - c. All sales and shipments of Products shall be FOB shipping point (unless otherwise stated in writing by Omron), at which point title and risk of loss shall pass from Omron to Buyer; provided that Omron shall retain a security interest in the Products until the full purchase price is paid;
 - d. Delivery and shipping dates are estimates only; and
 - e. Omron will package Products as it deems proper for protection against normal handling and extra charges apply to special conditions.
12. **Claims.** Any claim by Buyer against Omron for shortage or damage to the Products occurring before delivery to the carrier must be presented in writing to Omron within 30 days of receipt of shipment and include the original transportation bill signed by the carrier noting that the carrier received the Products from Omron in the condition claimed.
13. **Warranties.** (a) **Exclusive Warranty.** Omron's exclusive warranty is that the Products will be free from defects in materials and workmanship for a period of twelve months from the date of sale by Omron (or such other period expressed in writing by Omron). Omron disclaims all other warranties, express or implied. (b) **Limitations.** OMRON MAKES NO WARRANTY OR REPRESENTATION, EXPRESS OR IMPLIED, ABOUT NON-INFRINGEMENT, MERCHANTABILITY OR FITNESS FOR A PARTICULAR PURPOSE OF THE PRODUCTS. BUYER ACKNOWLEDGES THAT IT ALONE HAS DETERMINED THAT THE PRODUCTS WILL SUITABLY MEET THE REQUIREMENTS OF THEIR INTENDED USE. Omron further disclaims all warranties and responsibility of any type for claims or expenses based on infringement by the Products or otherwise of any intellectual property right. (c) **Buyer Remedy.** Omron's sole obligation hereunder shall be, at Omron's election, to (i) replace (in the form originally shipped with Buyer responsible for labor charges for removal or replacement thereof) the non-complying Product, (ii) repair the non-complying Product, or (iii) repay or credit Buyer an amount equal to the purchase price of the non-complying Product; provided that in no event shall Omron be responsible for warranty, repair, indemnity or any other claims or expenses regarding the Products unless Omron's analysis confirms that the Products were properly handled, stored, installed and maintained and not subject to contamination, abuse, misuse or inappropriate modification. Return of any Products by Buyer must be approved in writing by Omron before shipment. Omron Companies shall not be liable for the suitability or unsuitability or the results from the use of Products in combination with any electrical or electronic components, circuits, system assemblies or any other materials or substances or environments. Any advice, recommendations or information given orally or in writing, are not to be construed as an amendment or addition to the above warranty. See <http://www.omron247.com> or contact your Omron representative for published information.
14. **Limitation on Liability; Etc.** OMRON COMPANIES SHALL NOT BE LIABLE FOR SPECIAL, INDIRECT, INCIDENTAL, OR CONSEQUENTIAL DAMAGES, LOSS OF PROFITS OR PRODUCTION OR COMMERCIAL LOSS IN ANY WAY CONNECTED WITH THE PRODUCTS, WHETHER SUCH CLAIM IS BASED IN CONTRACT, WARRANTY, NEGLIGENCE OR STRICT LIABILITY. Further, in no event shall liability of Omron Companies exceed the individual price of the Product on which liability is asserted.
15. **Indemnities.** Buyer shall indemnify and hold harmless Omron Companies and their employees from and against all liabilities, losses, claims, costs and expenses (including attorney's fees and expenses) related to any claim, investigation, litigation or proceeding (whether or not Omron is a party) which arises or is alleged to arise from Buyer's acts or omissions under these Terms or in any way with respect to the Products. Without limiting the foregoing, Buyer (at its own expense) shall indemnify and hold harmless Omron and defend or settle any action brought against such Companies to the extent based on a claim that any Product made to Buyer specifications infringed intellectual property rights of another party.
16. **Property; Confidentiality.** Any intellectual property in the Products is the exclusive property of Omron Companies and Buyer shall not attempt to duplicate it in any way without the written permission of Omron. Notwithstanding any charges to Buyer for engineering or tooling, all engineering and tooling shall remain the exclusive property of Omron. All information and materials supplied by Omron to Buyer relating to the Products are confidential and proprietary, and Buyer shall limit distribution thereof to its trusted employees and strictly prevent disclosure to any third party.
17. **Export Controls.** Buyer shall comply with all applicable laws, regulations and licenses regarding (i) export of products or information; (ii) sale of products to "forbidden" or other proscribed persons; and (iii) disclosure to non-citizens of regulated technology or information.
18. **Miscellaneous.** (a) **Waiver.** No failure or delay by Omron in exercising any right and no course of dealing between Buyer and Omron shall operate as a waiver of rights by Omron. (b) **Assignment.** Buyer may not assign its rights hereunder without Omron's written consent. (c) **Law.** These Terms are governed by the law of the jurisdiction of the home office of the Omron company from which Buyer is purchasing the Products (without regard to conflict of law principles). (d) **Amendment.** These Terms constitute the entire agreement between Buyer and Omron relating to the Products, and no provision may be changed or waived unless in writing signed by the parties. (e) **Severability.** If any provision hereof is rendered ineffective or invalid, such provision shall not invalidate any other provision. (f) **Setoff.** Buyer shall have no right to set off any amounts against the amount owing in respect of this invoice. (g) **Definitions.** As used herein, "including" means "including without limitation"; and "Omron Companies" (or similar words) mean Omron Corporation and any direct or indirect subsidiary or affiliate thereof.

Certain Precautions on Specifications and Use

1. **Suitability of Use.** Omron Companies shall not be responsible for conformity with any standards, codes or regulations which apply to the combination of the Product in the Buyer's application or use of the Product. At Buyer's request, Omron will provide applicable third party certification documents identifying ratings and limitations of use which apply to the Product. This information by itself is not sufficient for a complete determination of the suitability of the Product in combination with the end product, machine, system, or other application or use. Buyer shall be solely responsible for determining appropriateness of the particular Product with respect to Buyer's application, product or system. Buyer shall take application responsibility in all cases but the following is a non-exhaustive list of applications for which particular attention must be given: (i) Outdoor use, uses involving potential chemical contamination or electrical interference, or conditions or uses not described in this document. (ii) Use in consumer products or any use in significant quantities. (iii) Energy control systems, combustion systems, railroad systems, aviation systems, medical equipment, amusement machines, vehicles, safety equipment, and installations subject to separate industry or government regulations. (iv) Systems, machines and equipment that could present a risk to life or property. Please know and observe all prohibitions of use applicable to this Product. NEVER USE THE PRODUCT FOR AN APPLICATION INVOLVING SERIOUS RISK TO LIFE OR PROPERTY OR IN LARGE QUANTITIES WITHOUT ENSURING THAT THE SYSTEM AS A WHOLE HAS BEEN DESIGNED TO ADDRESS THE RISKS, AND THAT THE OMRON'S PRODUCT IS PROPERLY RATED AND INSTALLED FOR THE INTENDED USE WITHIN THE OVERALL EQUIPMENT OR SYSTEM.
2. **Programmable Products.** Omron Companies shall not be responsible for the user's programming of a programmable Product, or any consequence thereof.
3. **Performance Data.** Data presented in Omron Company websites, catalogs and other materials is provided as a guide for the user in determining suitability and does not constitute a warranty. It may represent the result of Omron's test conditions, and the user must correlate it to actual application requirements. Actual performance is subject to the Omron's Warranty and Limitations of Liability.
4. **Change in Specifications.** Product specifications and accessories may be changed at any time based on improvements and other reasons. It is our practice to change part numbers when published ratings or features are changed, or when significant construction changes are made. However, some specifications of the Product may be changed without any notice. When in doubt, special part numbers may be assigned to fix or establish key specifications for your application. Please consult with your Omron's representative at any time to confirm actual specifications of purchased Product.
5. **Errors and Omissions.** Information presented by Omron Companies has been checked and is believed to be accurate; however, no responsibility is assumed for clerical, typographical or proofreading errors or omissions.



OMRON ELECTRONICS LLC • THE AMERICAS HEADQUARTERS • Schaumburg, IL USA • 847.843.7900 • 800.556.6766 • www.omron247.com

OMRON CANADA, INC. • HEAD OFFICE

Toronto, ON, Canada • 416.286.6465 • 866.986.6766
www.omron247.com

OMRON ELETRÔNICA DO BRASIL LTDA • HEAD OFFICE

São Paulo, SP, Brasil • 55.11.2101.6300 • www.omron.com.br

OMRON ELECTRONICS MEXICO SA DE CV • HEAD OFFICE

Apodaca, N.L. • 52.811.156.99.10 • 001.800.556.6766 • mela@omron.com

OMRON ARGENTINA • SALES OFFICE

Cono Sur • 54.11.4783.5300

OMRON CHILE • SALES OFFICE

Santiago • 56.9.9917.3920

OTHER OMRON LATIN AMERICA SALES

54.11.4783.5300

OMRON EUROPE B.V. Wegalaan 67-69, NL-2132 JD, Hoofddorp, The Netherlands. Tel: +31 (0) 23 568 13 00 Fax: +31 (0) 23 568 13 88 www.industrial.omron.eu