

## Silicon PIN Photodiode

### Description

The BPW34 is a high speed and high sensitive PIN photodiode in a miniature flat plastic package. Its top view construction makes it ideal as a low cost replacement of TO-5 devices in many applications.

Due to its waterclear epoxy the device is sensitive to visible and infrared radiation. The large active area combined with a flat case gives a high sensitivity at a wide viewing angle.

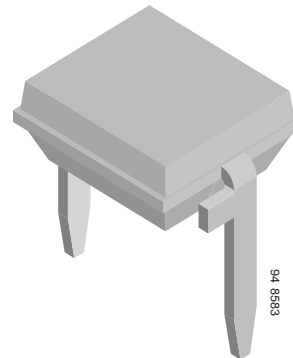

### Features

- Large radiant sensitive area ( $A = 7.5 \text{ mm}^2$ )
- Wide angle of half sensitivity  $\varphi = \pm 65^\circ$
- High photo sensitivity
- Fast response times
- Small junction capacitance
- Suitable for visible and near infrared radiation
- Lead-free component
- Component in accordance to RoHS 2002/95/EC and WEEE 2002/96/EC

### Applications

High speed photo detector

### Absolute Maximum Ratings

$T_{\text{amb}} = 25^\circ\text{C}$ , unless otherwise specified

Parameter	Test condition	Symbol	Value	Unit
Reverse Voltage		$V_R$	60	V
Power Dissipation	$T_{\text{amb}} \leq 25^\circ\text{C}$	$P_V$	215	mW
Junction Temperature		$T_j$	100	$^\circ\text{C}$
Storage Temperature Range		$T_{\text{stg}}$	- 55 to + 100	$^\circ\text{C}$
Soldering Temperature	$t \leq 3 \text{ s}$	$T_{\text{sd}}$	260	$^\circ\text{C}$
Thermal Resistance Junction/ Ambient		$R_{\text{thJA}}$	350	K/W

### Electrical Characteristics

$T_{\text{amb}} = 25^\circ\text{C}$ , unless otherwise specified

Parameter	Test condition	Symbol	Min	Typ.	Max	Unit
Breakdown Voltage	$I_R = 100 \mu\text{A}$ , $E = 0$	$V_{(\text{BR})}$	60			V
Reverse Dark Current	$V_R = 10 \text{ V}$ , $E = 0$	$I_{\text{ro}}$		2	30	nA
Diode capacitance	$V_R = 0 \text{ V}$ , $f = 1 \text{ MHz}$ , $E = 0$	$C_D$		70		pF
	$V_R = 3 \text{ V}$ , $f = 1 \text{ MHz}$ , $E = 0$	$C_D$		25	40	pF

### Optical Characteristics

$T_{amb} = 25\text{ }^{\circ}\text{C}$ , unless otherwise specified

Parameter	Test condition	Symbol	Min	Typ.	Max	Unit
Open Circuit Voltage	$E_e = 1\text{ mW/cm}^2, \lambda = 950\text{ nm}$	$V_o$		350		mV
Temp. Coefficient of $V_o$	$E_e = 1\text{ mW/cm}^2, \lambda = 950\text{ nm}$	$TK_{V_o}$		-2.6		mV/K
Short Circuit Current	$E_A = 1\text{ klx}$	$I_k$		70		$\mu\text{A}$
	$E_e = 1\text{ mW/cm}^2, \lambda = 950\text{ nm}$	$I_k$		47		$\mu\text{A}$
Temp. Coefficient of $I_k$	$E_e = 1\text{ mW/cm}^2, \lambda = 950\text{ nm}$	$TK_{I_k}$		0.1		%/K
Reverse Light Current	$E_A = 1\text{ klx}, V_R = 5\text{ V}$	$I_{ra}$		75		$\mu\text{A}$
	$E_e = 1\text{ mW/cm}^2, \lambda = 950\text{ nm}, V_R = 5\text{ V}$	$I_{ra}$	40	50		$\mu\text{A}$
Angle of Half Sensitivity		$\phi$		$\pm 65$		deg
Wavelength of Peak Sensitivity		$\lambda_p$		900		nm
Range of Spectral Bandwidth		$\lambda_{0.5}$		600 to 1050		nm
Noise Equivalent Power	$V_R = 10\text{ V}, \lambda = 950\text{ nm}$	NEP		$4 \times 10^{-14}$		$\text{W}/\sqrt{\text{Hz}}$
Rise Time	$V_R = 10\text{ V}, R_L = 1\text{ k}\Omega, \lambda = 820\text{ nm}$	$t_r$		100		ns
Fall Time	$V_R = 10\text{ V}, R_L = 1\text{ k}\Omega, \lambda = 820\text{ nm}$	$t_f$		100		ns

### Typical Characteristics ( $T_{amb} = 25\text{ }^{\circ}\text{C}$ unless otherwise specified)

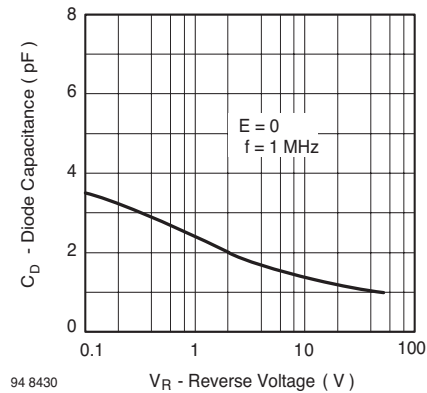

Figure 1. Reverse Dark Current vs. Ambient Temperature

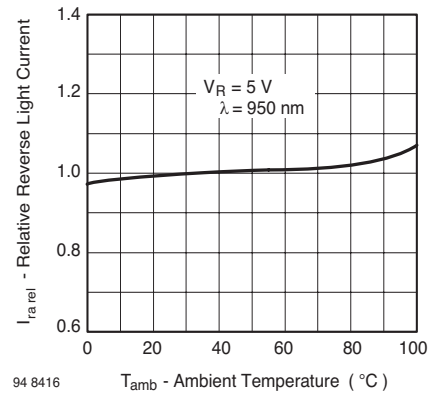
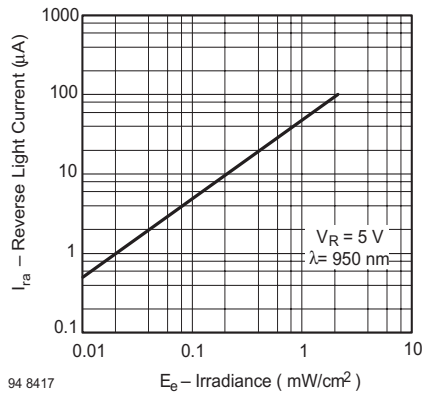
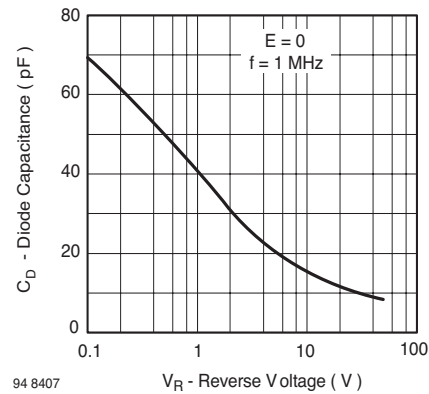

Figure 2. Relative Reverse Light Current vs. Ambient Temperature



94 8417

Figure 3. Reverse Light Current vs. Irradiance



94 8407

Figure 6. Diode Capacitance vs. Reverse Voltage

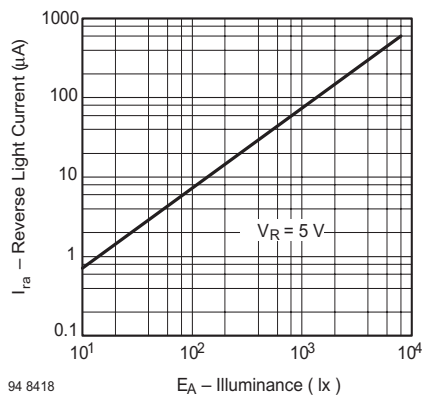

94 8418

Figure 4. Diode Capacitance vs. Reverse Voltage

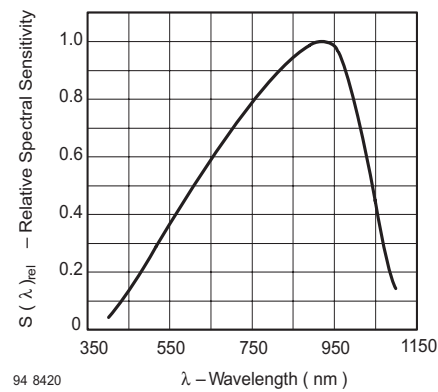

94 8420

Figure 7. Relative Spectral Sensitivity vs. Wavelength

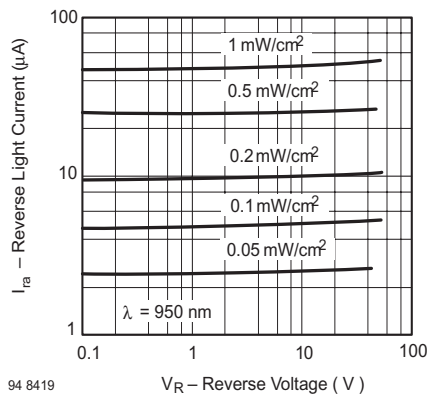

94 8419

Figure 5. Reverse Light Current vs. Reverse Voltage

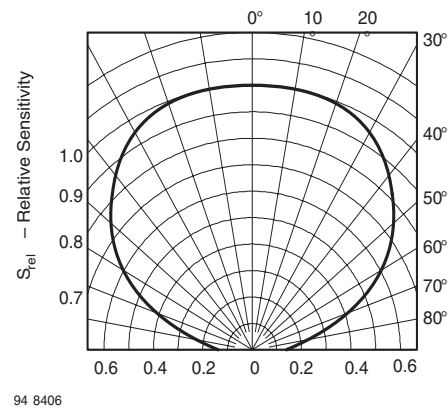

94 8406

Figure 8. Relative Radiant Sensitivity vs. Angular Displacement

### Package Dimensions in mm

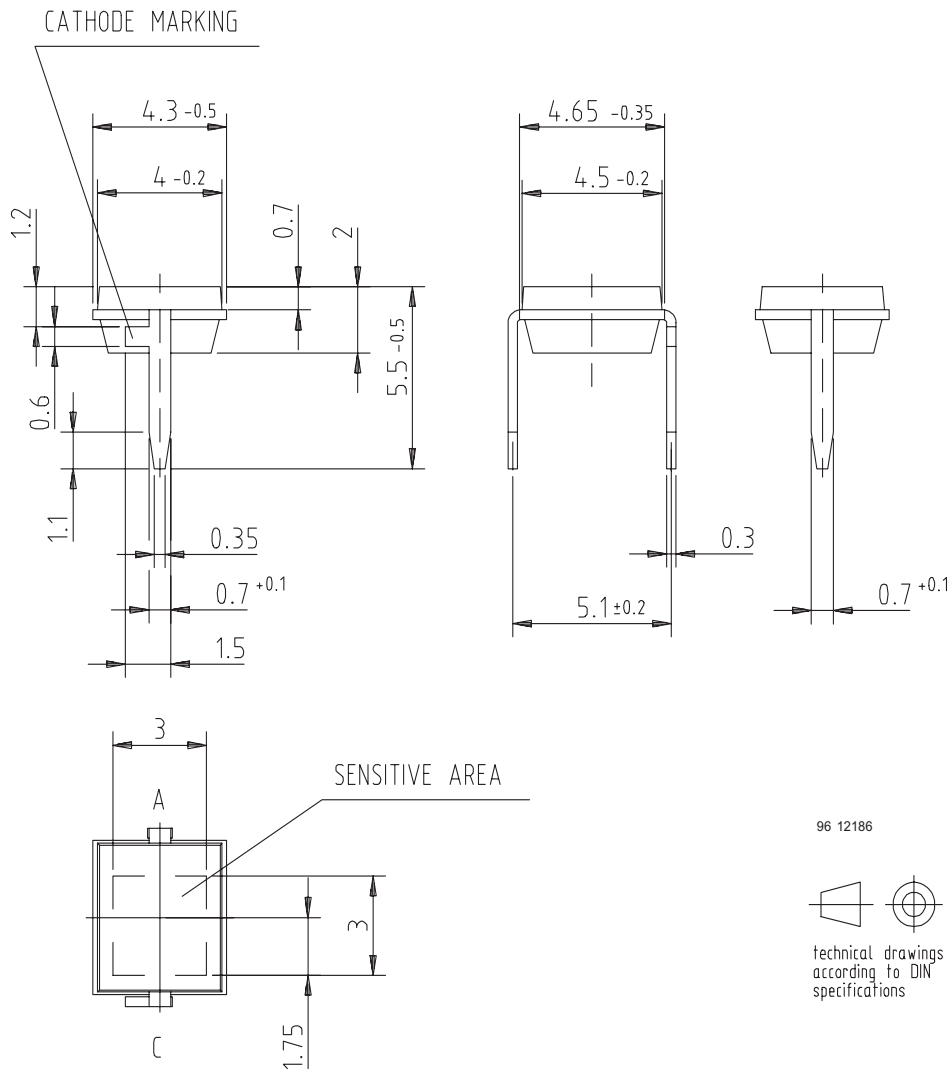

## Ozone Depleting Substances Policy Statement

It is the policy of Vishay Semiconductor GmbH to

1. Meet all present and future national and international statutory requirements.
2. Regularly and continuously improve the performance of our products, processes, distribution and operating systems with respect to their impact on the health and safety of our employees and the public, as well as their impact on the environment.

It is particular concern to control or eliminate releases of those substances into the atmosphere which are known as ozone depleting substances (ODSs).

The Montreal Protocol (1987) and its London Amendments (1990) intend to severely restrict the use of ODSs and forbid their use within the next ten years. Various national and international initiatives are pressing for an earlier ban on these substances.

Vishay Semiconductor GmbH has been able to use its policy of continuous improvements to eliminate the use of ODSs listed in the following documents.

1. Annex A, B and list of transitional substances of the Montreal Protocol and the London Amendments respectively
2. Class I and II ozone depleting substances in the Clean Air Act Amendments of 1990 by the Environmental Protection Agency (EPA) in the USA
3. Council Decision 88/540/EEC and 91/690/EEC Annex A, B and C (transitional substances) respectively.

Vishay Semiconductor GmbH can certify that our semiconductors are not manufactured with ozone depleting substances and do not contain such substances.

We reserve the right to make changes to improve technical design and may do so without further notice.

Parameters can vary in different applications. All operating parameters must be validated for each customer application by the customer. Should the buyer use Vishay Semiconductors products for any unintended or unauthorized application, the buyer shall indemnify Vishay Semiconductors against all claims, costs, damages, and expenses, arising out of, directly or indirectly, any claim of personal damage, injury or death associated with such unintended or unauthorized use.

Vishay Semiconductor GmbH, P.O.B. 3535, D-74025 Heilbronn, Germany  
Telephone: 49 (0)7131 67 2831, Fax number: 49 (0)7131 67 2423



### Notice

Specifications of the products displayed herein are subject to change without notice. Vishay Intertechnology, Inc., or anyone on its behalf, assumes no responsibility or liability for any errors or inaccuracies.

Information contained herein is intended to provide a product description only. No license, express or implied, by estoppel or otherwise, to any intellectual property rights is granted by this document. Except as provided in Vishay's terms and conditions of sale for such products, Vishay assumes no liability whatsoever, and disclaims any express or implied warranty, relating to sale and/or use of Vishay products including liability or warranties relating to fitness for a particular purpose, merchantability, or infringement of any patent, copyright, or other intellectual property right.

The products shown herein are not designed for use in medical, life-saving, or life-sustaining applications. Customers using or selling these products for use in such applications do so at their own risk and agree to fully indemnify Vishay for any damages resulting from such improper use or sale.