

Description

- 160°C maximum total temperature
- Three sizes of surface mount torroidal common mode inductors that provide 300Vdc isolation
- Inductance range from 5.5uH to 1600uH
- Current range up to 7.0 Amps
- Noise attenuation up to 44 dB
- Frequency range up to 100 MHz
- Meets UL94V-0 flammability standard
- Ferrite core material



Applications

- EMI filters
- DC-DC brick power supplies
- Discrete output supplies
- Discrete and point-of-use power supplies (PUPS)

Environmental Data

- Storage temperature range: -40°C to +160°C
- Operating ambient temperature range: -40°C to +160°C (range is application specific)
- Solder reflow temperature: +260°C max for 10 seconds max.

Packaging

- Supplied in tape and reel packaging, 2,000 (CMS1), 800 (CMS2), and 600 (CMS3) per reel

Part Number	OCL (uH) minimum (1-2) & (3-4)	I rms. Amperes Max *	DCR (Ω) typ @ 20°C (1-2)	DCR (Ω) typ @ 20°C (4-3)	Leakage Inductance (uH) typ	Interwinding Capacitance (pF) typ
CMS1-1-R	4.5	7.00	0.0027	0.0027	0.05	2.0
CMS1-2-R	8	5.70	0.0040	0.0040	0.09	2.1
CMS1-3-R	12.6	4.10	0.0077	0.0077	0.14	2.2
CMS1-4-R	18	3.80	0.0089	0.0089	0.20	2.3
CMS1-5-R	25	3.60	0.0100	0.0100	0.28	2.4
CMS1-6-R	32.8	3.10	0.0138	0.0138	0.36	2.5
CMS1-7-R	41.5	2.60	0.019	0.019	0.45	2.6
CMS1-8-R	51.2	2.20	0.026	0.026	0.056	2.7
CMS1-9-R	62	1.90	0.035	0.035	0.68	2.7
CMS1-10-R	73.7	1.65	0.048	0.048	0.81	2.8
CMS1-11-R	100	1.35	0.070	0.070	1.10	2.9
CMS1-12-R	131	1.15	0.100	0.100	1.45	3.0
CMS1-13-R	166	1.00	0.138	0.138	1.83	3.1
CMS1-14-R	205	0.85	0.186	0.186	2.25	3.2
CMS2-1-R	25	5.35	0.005	0.005	0.22	2.0
CMS2-2-R	40	4.40	0.008	0.008	0.34	2.3
CMS2-3-R	57	3.60	0.012	0.012	0.47	2.5
CMS2-4-R	102	2.80	0.019	0.019	0.80	2.8
CMS2-5-R	160	2.30	0.029	0.029	1.25	3.1
CMS2-6-R	230	1.85	0.044	0.044	1.75	3.4
CMS2-7-R	270	1.60	0.060	0.060	2.00	3.6
CMS2-8-R	360	1.35	0.084	0.084	2.60	3.9
CMS2-9-R	460	1.10	0.120	0.120	3.30	4.1
CMS2-10-R	575	0.94	0.170	0.170	4.00	4.3
CMS2-11-R	700	0.80	0.230	0.230	5.00	4.6
CMS2-12-R	915	0.67	0.330	0.330	6.30	4.9
CMS2-13-R	1070	0.58	0.440	0.440	7.30	5.1
CMS2-14-R	1340	0.50	0.620	0.620	9.00	5.4
CMS3-1-R	28	5.70	0.005	0.005	0.31	2.80
CMS3-2-R	45	5.10	0.006	0.006	0.46	3.05
CMS3-3-R	64	4.75	0.007	0.007	0.64	3.30

Definitions:

OCL = Open Circuit Inductance

DCR = Direct Current Resistance

I rms = rms current for approx. a 40°C temperature rise at an ambient temperature of 85°C.

*Operating Temperature: 160°C Max. Inductance values are sustained up to 160°C.

Electrical Characteristics:

OCL (1-2) 0.10Vrms, 100kHz, 0.0Adc: (See Chart)

OCL (4-3) 0.10Vrms, 100kHz, 0.0Adc: (See Chart)

DCR (1-2) typ @ 20°C: (See Chart)

DCR (4-3) typ @ 20°C: (See Chart)

Hipot rating: winding to winding: 300Vdc min. for 1 second.

Turns Ratio: (1-2):(4-3) 1:1

Part Number	OCL (uH) minimum (1-2) & (3-4)	I rms. Amperes Max *	DCR (Ω) typ @ 20°C (1-2)	DCR (Ω) typ @ 20°C (4-3)	Leakage Inductance (uH) typ	Interwinding Capacitance (pF) typ
CMS3-4-R	88	3.95	0.010	0.010	0.85	3.50
CMS3-5-R	146	3.10	0.017	0.017	1.30	3.70
CMS3-6-R	217	2.85	0.020	0.020	1.90	3.90
CMS3-7-R	258	2.45	0.027	0.027	2.20	4.15
CMS3-8-R	350	2.00	0.040	0.040	3.00	4.40
CMS3-9-R	400	1.70	0.053	0.053	3.30	4.65
CMS3-10-R	518	1.45	0.076	0.076	4.20	4.85
CMS3-11-R	648	1.20	0.107	0.107	5.10	5.10
CMS3-12-R	790	1.05	0.145	0.145	6.10	5.35
CMS3-13-R	1030	0.88	0.210	0.210	7.80	5.55
CMS3-14-R	1310	0.75	0.300	0.300	9.60	5.80

Definitions:

OCL = Open Circuit Inductance

DCR = Direct Current Resistance

I_{rms} = rms current for approx. a 40°C temperature rise at an ambient temperature of 85°C.

*Operating Temperature: 160°C Max. Inductance values are sustained up to 160°C.

Electrical Characteristics:

OCL (1-2) 0.10Vrms, 100kHz, 0.0Adc: (See Chart)

OCL (4-3) 0.10Vrms, 100kHz, 0.0Adc: (See Chart)

DCR (1-2) typ @ 20°C: (See Chart)

DCR (4-3) typ @ 20°C: (See Chart)

Hipot rating: winding to winding: 300Vdc min. for 1 second.

Turns Ratio: (1-2):(4-3) 1:1

Mechanical Diagrams

CMS1 Series

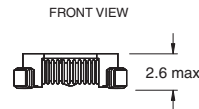
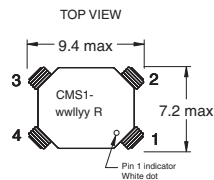

RECOMMENDED PCB LAYOUT

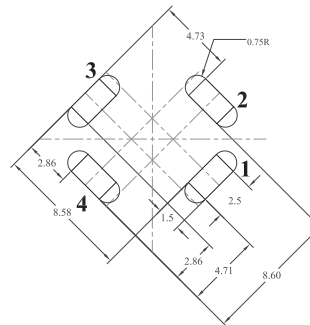

SCHEMATIC

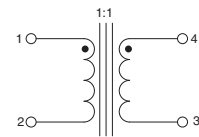

CMS2 Series

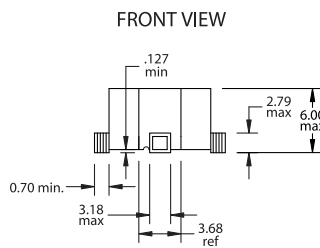
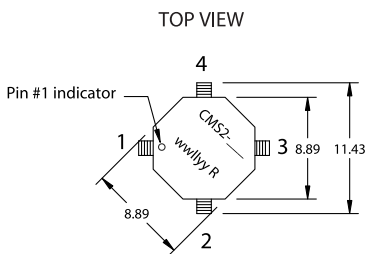

RECOMMENDED PCB LAYOUT

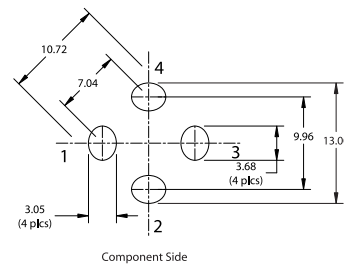

SCHEMATIC

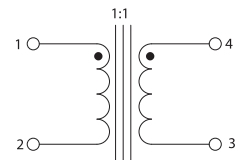

CMS3 Series

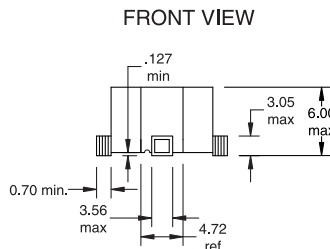
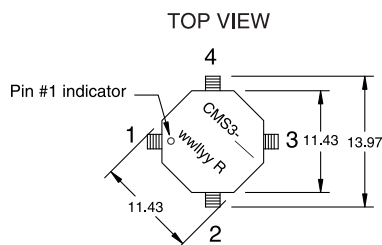

RECOMMENDED PCB LAYOUT

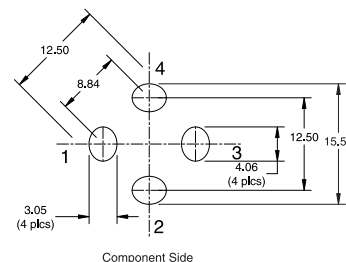

SCHEMATIC

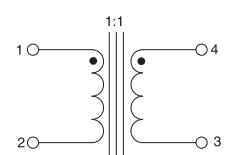

wwllyy = Date code R = Revision level

Packaging Information

CMS1 Series

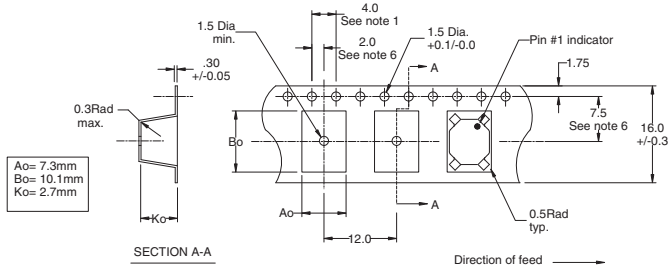

CMS2 Series

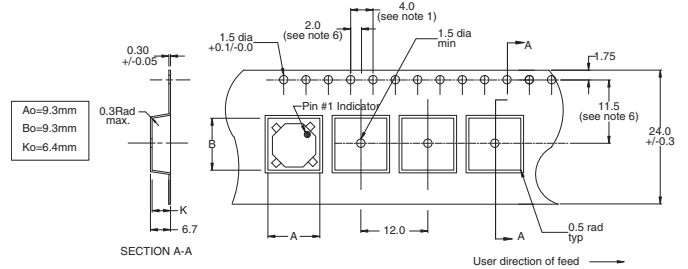

CMS3 Series

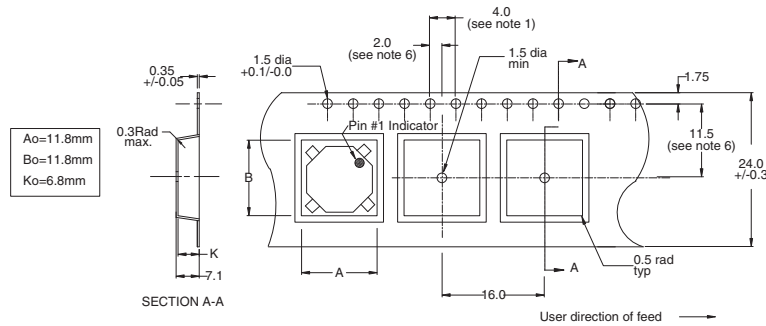

Attenuation Curves

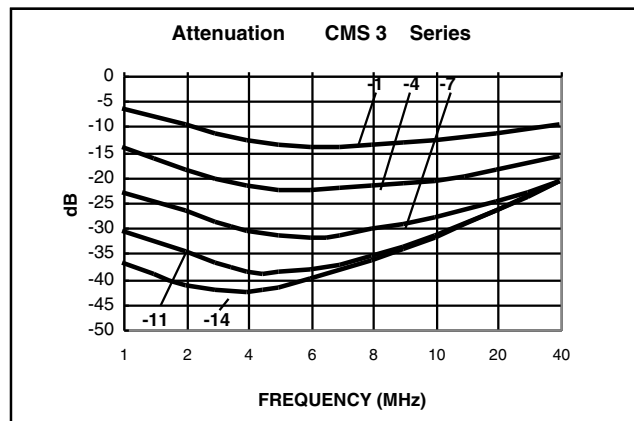
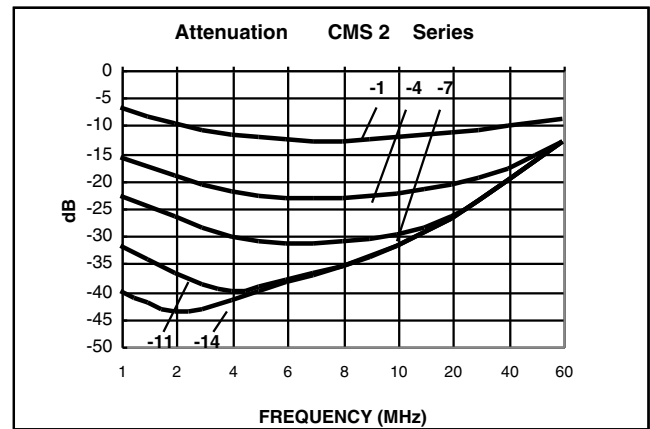
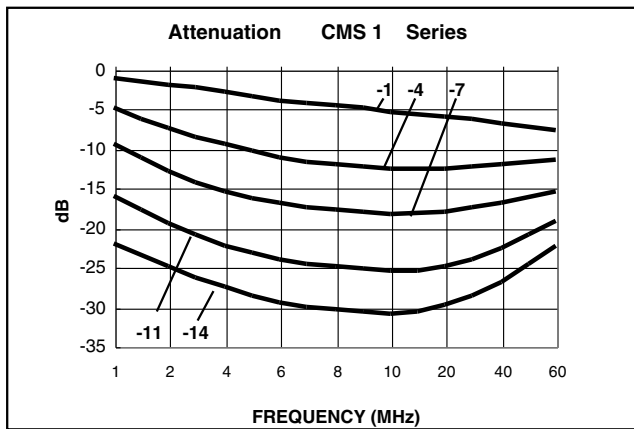

Impedance Curves

