

30 Volt DC Radial Leaded, PolyTron™ PTC Devices

PolyTron™ PTR030V Series



Radial Leaded Device

Description

- PolyTron™ radial leaded thru-hole PTC device
- Maximum 30 volts
- Current ratings from 0.90 to 9.00 amps
- Fast time-to-trip
- Low resistance
- Halogen free
- Lead free
- RoHS compliant

Agency Information

- cURus: Recognized Card: File E343021 (I_{hold} 0.9-9A)
- TUV File: J 50194729

Part Number System/Ordering

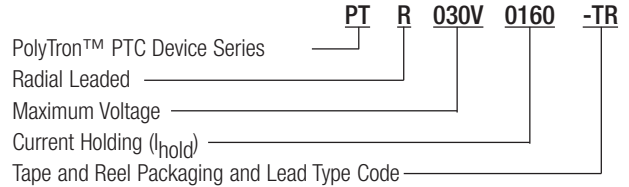

Lead Codes: TR & BK - Straight Leads, TR1 & BK1 - Kinked Leads

TR & TR1 On Reels

- 0.90-1.60A - 3000 devices
- 1.85-3.00A - 2000 devices
- 4.00-9.00A - 1000 devices

BK & BK1 In Poly Bags

- 0.90-1.35A - 1,000 devices
- 1.60-6.00A - 500 devices
- 7.00-9.00A - 250 devices

Applications

- Medical equipment
- White goods
- Industrial power transmission
- Telecommunications
- Computers and peripherals
- Consumer and automotive electronics
- Rechargeable battery packs

Specifications

Catalog Number	V _{max} (Vdc)	I _{max} (Amps)	I _{hold} @23°C (Amps)	I _{trip} @23°C (Amps)	P _d Typ. (W)	Time to Trip (Max.)		Resistance (Ω)			Agency Information	
								Initial (R _i)		Post Trip (R ₁)		
						(Amps)	(Sec)	Min.	Max.		Max.	cURus
PTR030V0090	30	40	0.90	1.80	0.6	4.50	5.90	0.070	0.120	0.22	X	X
PTR030V0110	30	40	1.10	2.20	0.7	5.50	6.60	0.050	0.100	0.17	X	X
PTR030V0135	30	40	1.35	2.70	0.8	6.75	7.30	0.040	0.080	0.13	X	X
PTR030V0160	30	40	1.60	3.20	0.9	8.00	8.00	0.030	0.070	0.11	X	X
PTR030V0185	30	40	1.85	3.70	1.0	9.25	8.70	0.030	0.060	0.09	X	X
PTR030V0250	30	40	2.50	5.00	1.2	12.50	10.30	0.020	0.040	0.07	X	X
PTR030V0300	30	40	3.00	6.00	2.0	15.00	10.80	0.020	0.050	0.08	X	X
PTR030V0400	30	40	4.00	8.00	2.5	20.00	12.70	0.010	0.030	0.05	X	X
PTR030V0500	30	40	5.00	10.00	3.0	25.00	14.50	0.010	0.030	0.05	X	X
PTR030V0600	30	100	6.00	12.00	3.5	30.00	16.00	0.005	0.020	0.04	X	X
PTR030V0700	30	100	7.00	14.00	3.8	35.00	17.50	0.005	0.020	0.03	X	X
PTR030V0800	30	100	8.00	16.00	4.0	40.00	18.80	0.005	0.013	0.02	X	X
PTR030V0900	30	100	9.00	18.00	4.2	45.00	20.00	0.005	0.010	0.02	X	X

Notes: I_{hold} – Hold current: Maximum current device will pass without interruption in 23°C still air.
 I_{trip} – Trip current: Minimum current that will switch the device from low resistance to high resistance in 23°C still air.
 V_{max}: Maximum continuous voltage device can withstand without damage at rated current.
 I_{max}: Maximum fault current device can withstand without damage at rated voltage.
 P_d: Power dissipated from device when in the tripped state in 23°C still air.
 R_i (min.): Minimum resistance of device as supplied at 23°C unless otherwise specified.
 R_i (max.): Maximum resistance of device as supplied at 23°C unless otherwise specified.
 R₁ (max.): Maximum resistance of device when measured one hour post reflow (SMD) or one hour post trip (radial-leaded device) at 23°C unless otherwise specified.

Dimensions - mm

Part Number	A Max.	B Max Lead Type		C	D Min.	E Max.	F	Figure/Lead Style	
		Straight (-TR)	Kink (-TR1)					Straight TR	Kink TR1
PTR030V0090	7.4	12.2	12.2	5.0±0.8	7.6	3.0	0.5±0.02	2	1
PTR030V0110	7.4	14.2	14.2	5.0±0.8	7.6	3.0	0.5±0.02	2	1
PTR030V0135	8.9	13.5	13.5	5.0±0.8	7.6	3.0	0.5±0.02	2	1
PTR030V0160	8.9	15.2	15.2	5.0±0.8	7.6	3.0	0.5±0.02	2	1
PTR030V0185	10.2	15.7	15.7	5.0±0.8	7.6	3.0	0.5±0.02	2	1
PTR030V0250	11.4	18.3	20.5	5.0±0.8	7.6	3.0	0.5±0.02	2	1
PTR030V0300	11.4	17.3	21.8	5.0±0.8	7.6	3.0	0.8±0.02	2	1
PTR030V0400	14.0	20.1	24.6	5.0±0.8	7.6	3.0	0.8±0.02	2	1
PTR030V0500	14.0	24.9	26.6	10.0±0.8	7.6	3.0	0.8±0.02	2	1
PTR030V0600	16.5	24.9	29.4	10.0±0.8	7.6	3.0	0.8±0.02	2	1
PTR030V0700	19.1	26.7	31.2	10.0±0.8	7.6	3.0	0.8±0.02	2	1
PTR030V0800	21.6	29.2	33.7	10.0±0.8	7.6	3.0	0.8±0.02	2	1
PTR030V0900	24.1	29.7	34.2	10.0±0.8	7.6	3.0	0.8±0.02	2	1

Style 1

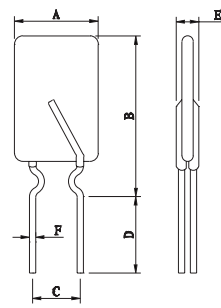

Style 2

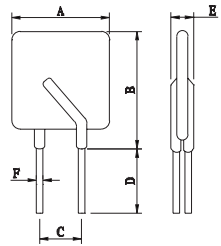

Time-to-Trip Curves at 23°C

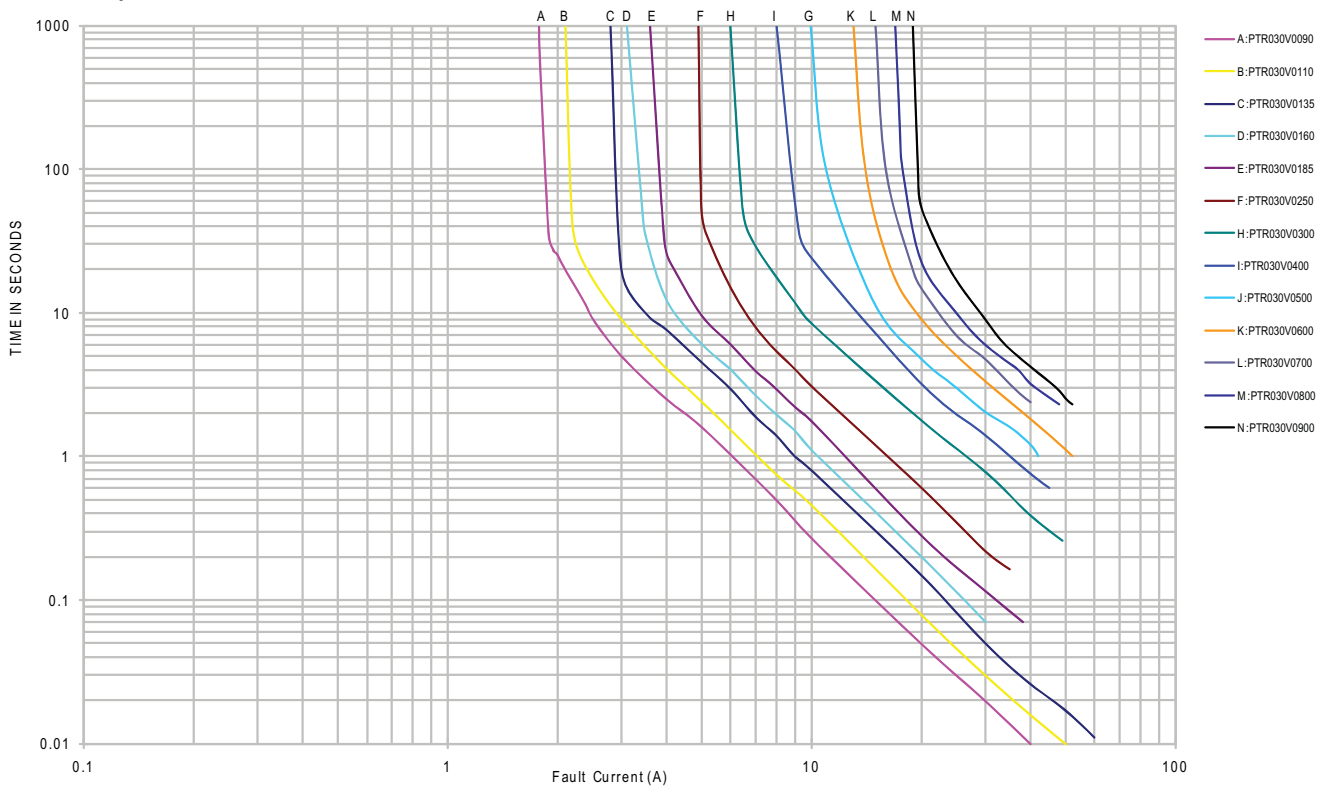

Thermal Derating Curve

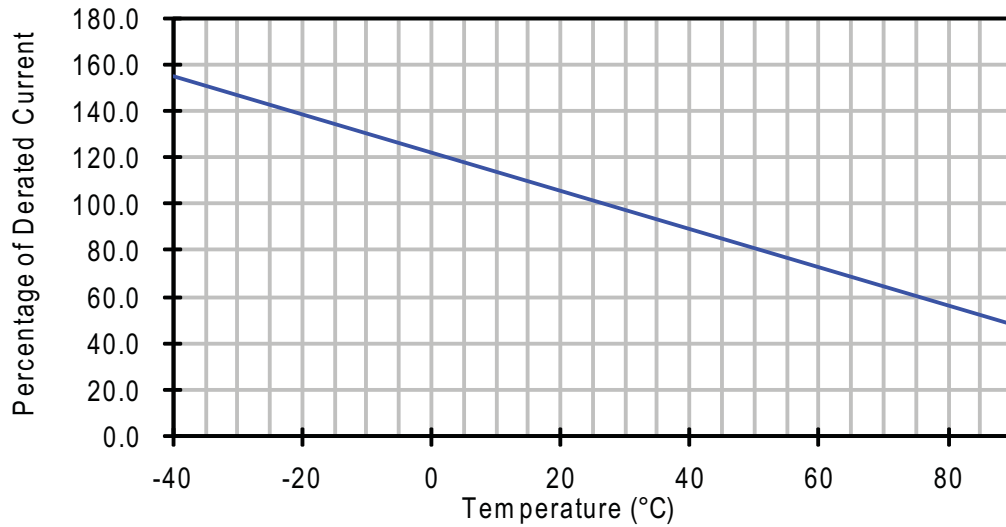

Recommended Wave Solder Profile.

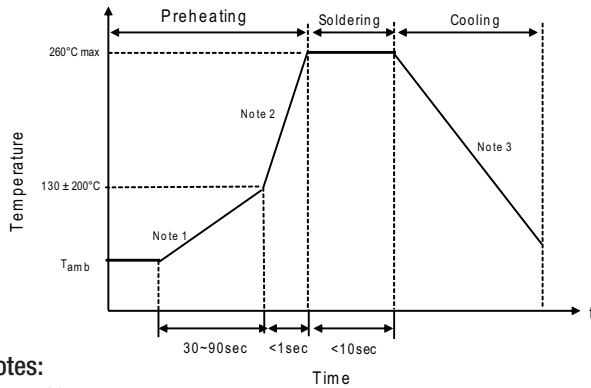

Notes:

1. (1-3) $^\circ\text{C}/\text{sec}$
2. Approximately $200^\circ\text{C}/\text{sec}$
3. $5^\circ\text{C}/\text{sec}$ Maximum

Recommended Reworking Conditions with Soldering Iron

- Soldering Iron Tip Temperature: 360°C max .
- Solder Time: 3 seconds max.
- Distance from Thermistor: 2mm min.

Environmental Specifications

Characteristic	Value
Operating Temperature Range	-40°C to $+85^\circ\text{C}$
Surface Temperature Trip State	125°C max .
Thermal Shock	$+85^\circ\text{C}$ to -40°C , 10 cycles, 5% typical resistance change
Solvent Resistance	MIL-STD-202 Method 215, no change
Humidity Age Test	$+85^\circ\text{C}$, 85% R.H., 1000 hours $\pm 5\%$ typical resistance change. Specified temperature ($23^\circ\text{C} \pm 3^\circ\text{C}$)
Storage Temperature Range	-10°C to $+40^\circ\text{C}$
Storage Duration	One year
Storage Relative Humidity	$\leq 75\%$
Storage Conditions	Keep away from corrosive atmosphere and sunlight

Material Composition

- Lead material:
 - PTR030V0090-PTR030V0250 Tin-plated copper clad steel
 - PTR030V0300-PTR030V0900 Tin-plated copper
- Insulating material: Cured epoxy resin meeting UL 94V0 requirements

Packaging/Taping Specifications

Description	IEC Mark	Dimension (mm)	Tolerance (mm)
Sprocket hole pitch	P_0	12.7	0.3
Ordinate to adjacent component lead PTR030V0090~PTR030V0300	P_1	3.6	1.0
Ordinate to adjacent component lead PTR030V0400	P_1	3.45	1.0
Ordinate to adjacent component lead PTR030V0500~PTR030V0900	P_1	7.3	1.0
Device pitch PTR030V0090~PTR030V0300	P	12.7	1.0
Device pitch PTR030V0400~PTR030V0900	P	25.4	1.0
Lead spacing	C	*	--
Carrier tape width	W	18	1.0
Top distance between tape edges	W_0	3.0	Max.
Hold-down tape width	W_1	12	1.0
Sprocket hole position	W_2	9.0	+0.75/-0.5
Abscissa to top PTR030V0090~PTR030V0300	H_1	32.2	Max.
Abscissa to top PTR030V0400~PTR030V0900	H_1	47.5	Max.
Abscissa to plane (straight lead)	H	18.0	+2/-0
Abscissa to plane (kinked lead)	H_0	16.0	± 0.5
Sprocket hole diameter	D_0	4	± 0.2
Lead protrusion	L_1	1	Max.
Tape thickness	t	0.9	Max.
Body lateral deviation	Δ_h	0	± 1.0
Body tape plane deviation	Δ_p	0	± 0.13
Reel width	W_3	56	Max.
Reel diameter		340	± 10
Arbor hole diameter	n_0	31	± 1
Core diameter	n	80	Min.

* See Dimensions table.

Figure 1 - PTR030V0090-PTR030V0400

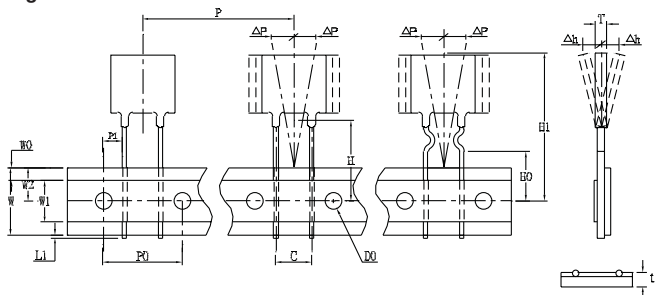
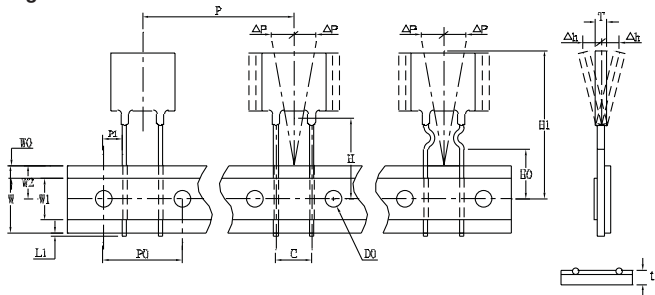
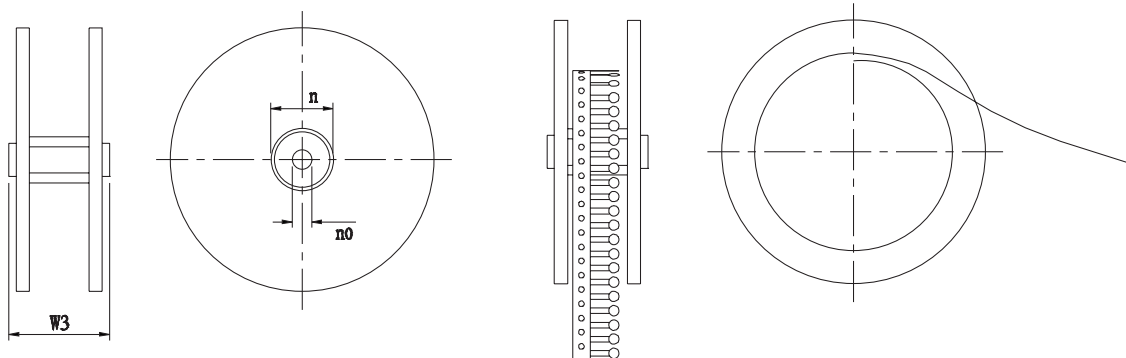

Figure 2 - PTR030V0500-PTR030V0900



Reel Specifications



The only controlled copy of this Data Sheet is the electronic read-only version located on the Cooper Bussmann Network Drive. All other copies of this document are by definition uncontrolled. This bulletin is intended to clearly present comprehensive product data and provide technical information that will help the end user with design applications. Cooper Bussmann reserves the right, without notice, to change design or construction of any products and to discontinue or limit distribution of any products. Cooper Bussmann also reserves the right to change or update, without notice, any technical information contained in this bulletin. Once a product has been selected, it should be tested by the user in all possible applications.

Life Support Policy: Cooper Bussmann does not authorize the use of any of its products for use in life support devices or systems without the express written approval of an officer of the Company. Life support systems are devices which support or sustain life, and whose failure to perform, when properly used in accordance with instructions for use provided in the labeling, can be reasonably expected to result in significant injury to the user.