

Inlet filter, front side mounting, line switch 2-pole

Standard- or Medical-Filter



C14



70° C



### Description

- Panel Mount:
  - Screw-on from front side
- 3 Functions:
  - Inlet Protection class I, Line switch 2-pole, Line filter in standard and medical version
- Quick connect terminals 6.3 x 0.8 mm
- Alternative: version without line filter [KEB2](#)
- We recommend for new applications type [DC12](#)

### Approvals

- VDE License Number: 40004665
- UL License Number: E76360

### Characteristics

- All single elements are already wired
- Line switch non-illuminated
- With EMC-shield
- Qualified for use in equipment according IEC/EN 60950

### Weblinks

Approvals: <http://www.schurter.com/approvals>  
 RoHS: <http://www.schurter.com/rohs>

### Technical Data

Ratings IEC	1 - 10 A @ Ta 40 °C / 250 VAC; 50 Hz
Ratings UL/CSA	1 - 10 A @ Ta 40 °C / 125 VAC; 60 Hz
Leakage Current	standard < 0.5 mA (250 V / 60 Hz) medical < 5 µA (250 V / 60 Hz)
Dielectric Strength	> 1.7 kVDC between L-N > 2.7 kVDC between L/N-PE Test voltage (2 sec)
Allowable Operation Temp.	-25 °C to 85 °C
Climatic Category	25/085/21 acc. to, IEC 60068-1
Degree of Protection	from front side IP 40 acc. to IEC 60529
Protection Class	Suitable for appliances with protection class I acc. to IEC 61140
Terminal	Quick connect terminals 6.3 x 0.8 mm
Panel Thickness s	Screw-on: max 8 mm Mounting screw torque max 0.5 Nm
Material: Housing	Thermoplastic, black, UL 94V-0

Appliance-Inlet /-Outlet	C14 acc. to IEC/EN 60320-1, UL 498, CSA C22.2 no. 42 (for cold condition) pin-temperature 70 °C, 10 A, Protection class I
Line Switch	Rocker switch 2-pole, non-illuminated, acc. to IEC 61058-1 <a href="#">Technical details</a>
Line Filter	Standard and Medical Version, IEC 60939, IEC 60601-1, UL 1283, UL 544, EN 133 200, CSA C22.2 no. 8 <a href="#">Technical details</a>
MTBF	> 1'900'000 h acc. to MIL-HB-217 F

Dimensions

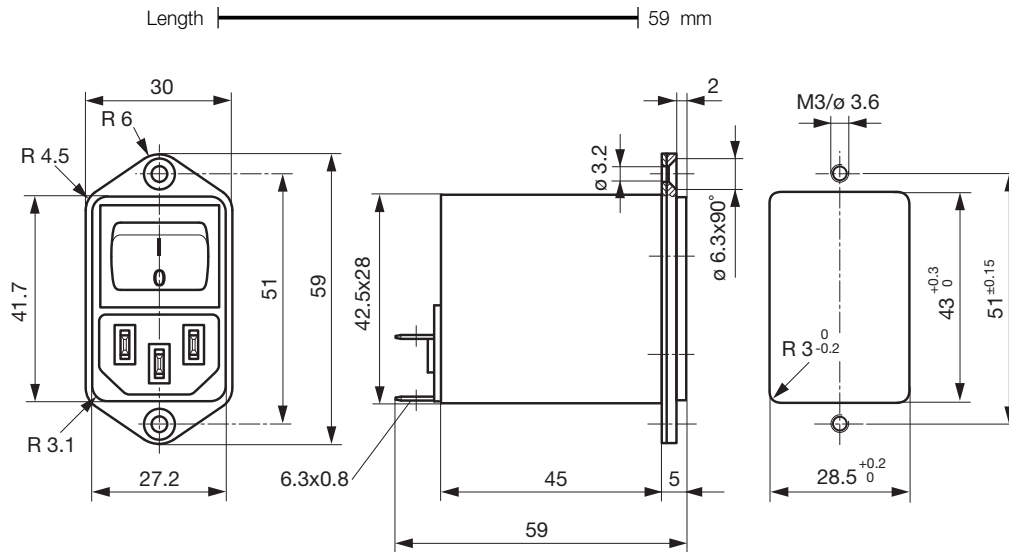

Technical Data of Filter-Components

Rated Current [A]	Filter-Type	Inductances	Capacitance	Capacitance	R [MΩ]
		L [mH]	CX [nF]	CY [nF]	
1	Standard Version	2 x 10	68	2.2	-
2	Standard Version	2 x 4	68	2.2	-
4	Standard Version	2 x 1.5	68	2.2	-
6	Standard Version	2 x 0.8	68	2.2	-
10	Standard Version	2 x 0.3	68	2.2	-
1	Medical Version (M5)	2 x 10	68	-	1
2	Medical Version (M5)	2 x 4	68	-	1
4	Medical Version (M5)	2 x 1.5	68	-	1
6	Medical Version (M5)	2 x 0.8	68	-	1
10	Medical Version (M5)	2 x 0.3	68	-	1

Diagrams

Standard version

Medical version

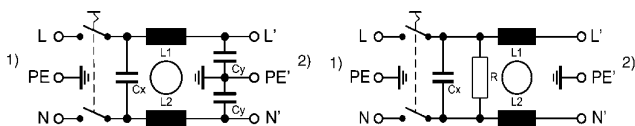

- 1) Line
- 2) Load

**Attenuation loss**

--- differential mode    \_\_\_\_ common mode

Standard version

1 A

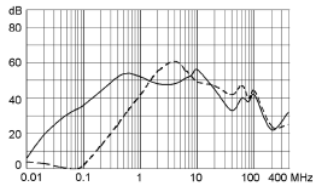

2 A

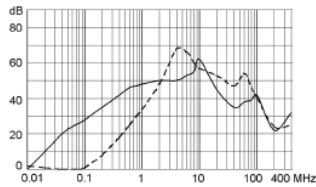

4 A

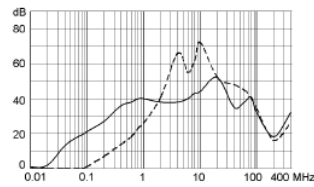

6 A

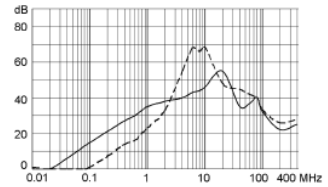

10 A

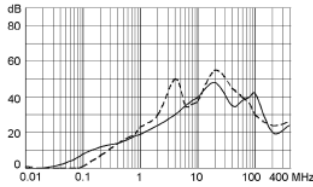

Medical version (M5)

4 A

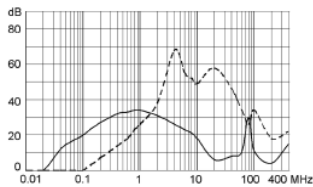

1 A

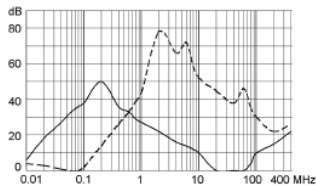

2 A

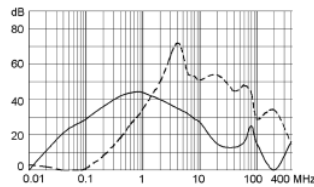

6 A

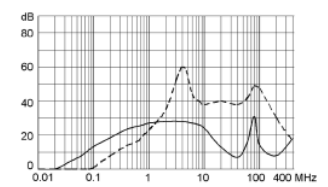

10 A

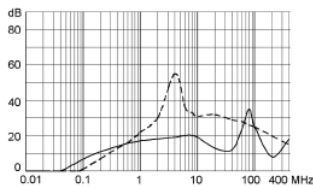

**Varianten**

Rated Current [A]	Filter-Type	Order Number
1	Standard Version	4302.5311
2	Standard Version	4302.5312
4	Standard Version	4302.5313
6	Standard Version	4302.5314
10	Standard Version	4302.5315
1	Medical Version (M5)	4302.5331
2	Medical Version (M5)	4302.5333
4	Medical Version (M5)	4302.5335
6	Medical Version (M5)	4302.5337
10	Medical Version (M5)	4302.5339

Packaging unit

10 Pcs

Accessory

Description



Assorted Covers



Cord retaining kits