

NOTES:
 1. MATERIAL; SEE LEGEND
 2. FINISH:
 *909 - OVERALL HOT TIN DP: .000100/(0.00254) MN.
 102 - OVERALL TIN: .000200/(0.00508) MN.
 OVERALL COPPER: .000100/(0.00254) MN.
 132 - OVERALL TIN: .000200/(0.00508) MN.
 OVERALL COPPER: .000200/(0.00508) MN.
 503 - OVERALL HARD GOLD: .000030/0.

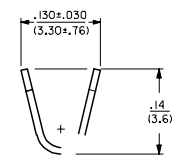

LEGEND: 6836-+ (+) + +
 MATERIAL: (27)/.0106 THK
 BLANK=BRASS
 A=PHOS BRONZE
 WINDING
 A= PER DETAIL A
 BLANK= PER DETAIL B
 FORM
 BLANK= CHAIN
 L= LOOSE
 PLATING
 SEE NOTE 2

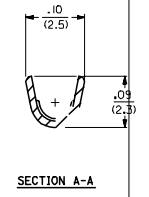
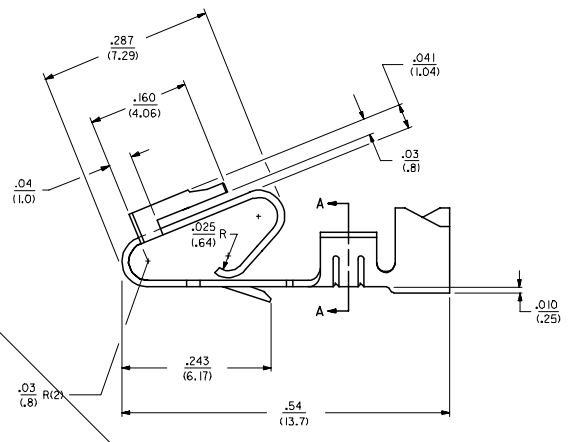
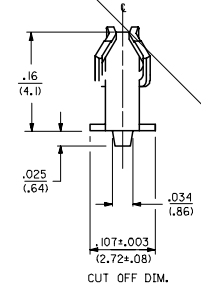
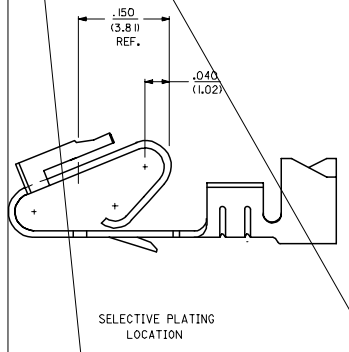
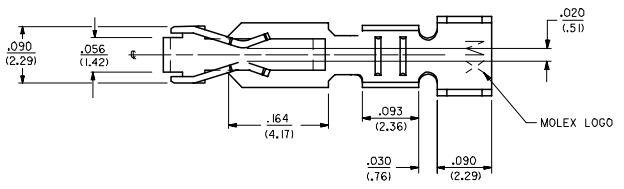
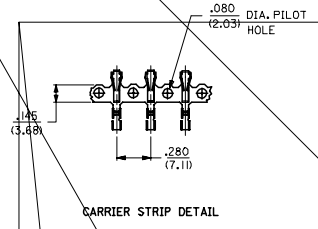