



Features:



- Ferrite based SMD inductor with lower core loss.
- Ideal for LCD driver, DSC/DVC, Notebook PC or High density board design.
- Operating temperature range -55°C to + 130°C.

MCSDRH73B - Series

- High current output chokes, up to 8 amperes with about 30% roll off.
- Low profile 3.55 mm maximum height.
- Foot print : 7.6 × 7.6 mm maximum.

MCSDRH125B - Series

- High current output chokes, up to 24.2 amperes with about 30% roll off.
- Low profile 6 mm maximum height.
- Foot print : 12.5 × 12.5 mm maximum.

Applications:

- Integrated DC/DC converter.
- Notebook computers.
- Excellent for power line DC-DC conversion application used in hard disk, notebook computers and other electronic equipment.

Figure 1

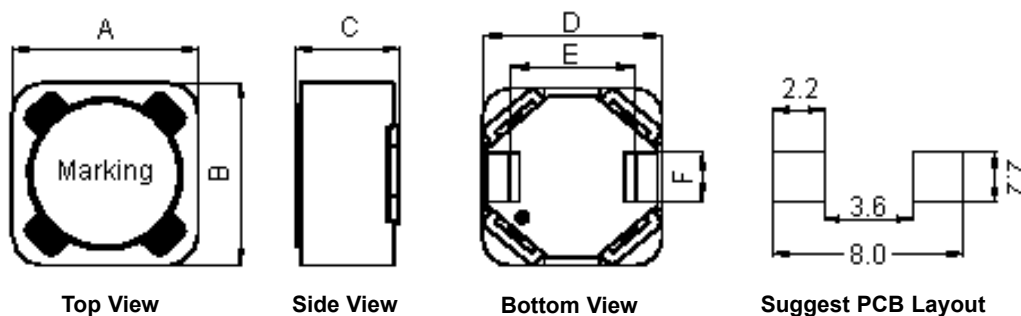
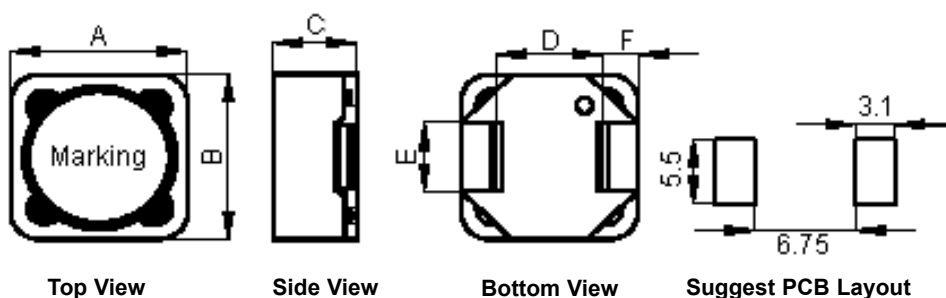

Figure 2



Dimensions : Millimetres

Mechanical Dimensions

Type	MCSDRH73B (Figure 1) (mm)		MCSDRH125B (Figure 2) (mm)	
A	7.3 ±0.3	-	12 ±0.5	-
B	7.3 ±0.3	-	12 ±0.5	-
C	3.55	(Maximum)	6	(Maximum)
D	7 ±0.3	-	7	(Reference)
E	3.9	(Reference)	5	(Reference)
F	2	(Reference)	2.5	(Reference)

Electrical Characteristics

OCL (μ H) ±20%	DCR (Ω) (Typical)	DCR (Ω) (Maximum)	I_{sat} (A) at 25°C	L at I_{sat} (μ H) (Typical)	I_{rms} (A) at 25°C	L at I_{rms} (μ H) (Typical)	Part Number
1	0.0091	0.0109	8	0.785	6.5	0.89	MCSDRH73B-1R0MHF
1.5	0.0125	0.015	6.52	1.186	5.54	1.325	MCSDRH73B-1R5MHF
2.2	0.018	0.0216	5.52	1.7	4.6	1.95	MCSDRH73B-2R2MHF
3.3	0.023	0.0276	4.4	2.69	4.08	2.84	MCSDRH73B-3R3MHF
4.7	0.0297	0.0356	3.78	3.63	3.65	3.8	MCSDRH73B-4R7MHF
6.8	0.0415	0.0498	3.12	5.53	3.04	5.66	MCSDRH73B-6R8MHF
8.2	0.0525	0.063	2.8	6.5	2.7	6.7	MCSDRH73B-8R2MHF
10	0.0656	0.0787	2.5	8.16	2.35	8.48	MCSDRH73B-100MHF
15	0.08	0.096	2.05	10.3	2.12	9.65	MCSDRH73B-150MHF
22	0.108	0.13	1.67	15.25	1.83	13.9	MCSDRH73B-220MHF
33	0.166	0.199	1.35	24.75	1.48	19.75	MCSDRH73B-330MHF
47	0.231	0.277	1.14	33.2	1.25	27.9	MCSDRH73B-470MHF
68	0.331	0.397	0.96	48	1.04	41.33	MCSDRH73B-680MHF
82	0.41	0.492	0.89	55.05	0.94	49.3	MCSDRH73B-820MHF
100	0.491	0.589	0.79	71	0.86	60.33	MCSDRH73B-101MHF
150	0.751	0.901	0.65	100.8	0.69	88.9	MCSDRH73B-151MHF
220	1.05	1.26	0.53	156.3	0.59	126	MCSDRH73B-221MHF
330	1.59	1.908	0.44	252.7	0.48	219.9	MCSDRH73B-331MHF
470	2.17	2.604	0.37	320.2	0.41	263.7	MCSDRH73B-471MHF
680	3.12	3.744	0.31	542.1	0.34	467.3	MCSDRH73B-681MHF
820	4.01	4.812	0.28	591.3	0.3	515.5	MCSDRH73B-821MHF
1000	5.06	6.072	0.25	679.9	0.27	578.4	MCSDRH73B-102MHF

Electrical Characteristics

OCL (μH) $\pm 20\%$	DCR (Ω) (Typical)	DCR (Ω) (Maximum)	I_{sat} (A) at 25°C	L at I_{sat} (μH) (Typical)	I_{rms} (A) at 25°C	L at I_{rms} (μH) (Typical)	Part Number
0.82	0.0039	0.0047	24.2	0.659	15.5	0.807	MCSDRH125B-R82MHF
1.5	0.0052	0.00625	18.5	1.12	13.3	1.4	MCSDRH125B-1R5MHF
2.2	0.0064	0.0077	14.8	1.75	12	2.05	MCSDRH125B-2R2MHF
3.3	0.0079	0.0095	12.6	2.65	10.8	2.95	MCSDRH125B-3R3MHF
4.7	0.0107	0.01285	10.1	3.6	9.3	4	MCSDRH125B-4R7MHF
6.8	0.0119	0.0143	8.4	5.75	8.8	5.5	MCSDRH125B-6R8MHF
8.2	0.0156	0.0187	7.6	6.6	7.7	6.5	MCSDRH125B-8R2MHF
10	0.0164	0.0197	6.9	8.3	7.5	7.45	MCSDRH125B-100MHF
15	0.0268	0.0322	5.65	11.2	5.8	10.77	MCSDRH125B-150MHF
22	0.0318	0.0382	4.7	18.7	5.4	15.3	MCSDRH125B-220MHF
33	0.0445	0.0534	4	26.65	4.5	21.7	MCSDRH125B-330MHF
47	0.0659	0.079	3.2	37.95	3.7	29.4	MCSDRH125B-470MHF
68	0.0991	0.119	2.7	55.6	3.05	45.3	MCSDRH125B-680MHF
82	0.121	0.145	2.4	67	2.75	52	MCSDRH125B-820MHF
100	0.155	0.186	2.2	79	2.4	66.7	MCSDRH125B-101MHF
150	0.217	0.26	1.8	124.8	2.05	98	MCSDRH125B-151MHF
220	0.321	0.385	1.5	182.4	1.7	148	MCSDRH125B-221MHF
330	0.434	0.52	1.2	284	1.45	206.5	MCSDRH125B-331MHF
470	0.627	0.753	1	402	1.2	293	MCSDRH125B-471MHF
680	0.888	1.066	0.85	548	1	404	MCSDRH125B-681MHF
820	1.093	1.312	0.76	680	0.92	511	MCSDRH125B-821MHF
1000	1.409	1.69	0.69	801	0.8	610	MCSDRH125B-102MHF

Note :

- OCL (Open Circuit Inductance) and L at I_{rms} and L at I_{sat} and DCR are measured at: 100 KHz, 0.25 V at 25°C.
- I_{sat} : DC current that causes inductance to drop by approximately 30% from OCL; ($T_a = 25^\circ\text{C}$).
- I_{rms} : DC current that causes an approximate temperature rise (ΔT) of 40°C; ($T_a = 25^\circ\text{C}$).
- Inductance Vs. DC bias curve, please see the next page to get more detail information.
- Inductance tolerance: $\pm 20\%$, Base type: Plastic.

SMD Power Inductors



Inductance vs. Current

MCSDRH73B-xMHF

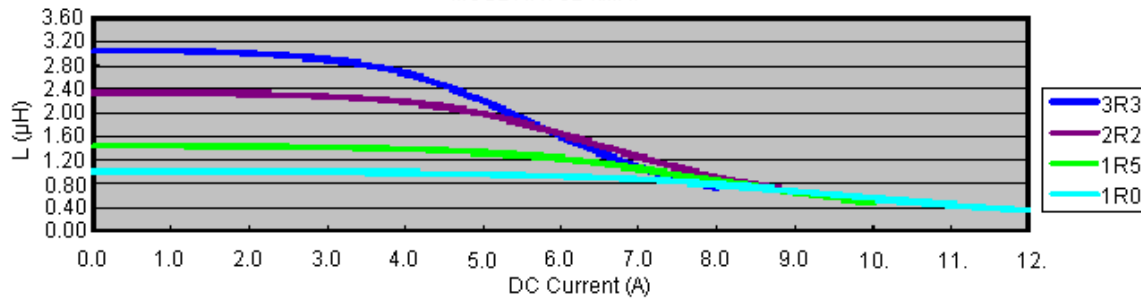

MCSDRH73B-xMHF

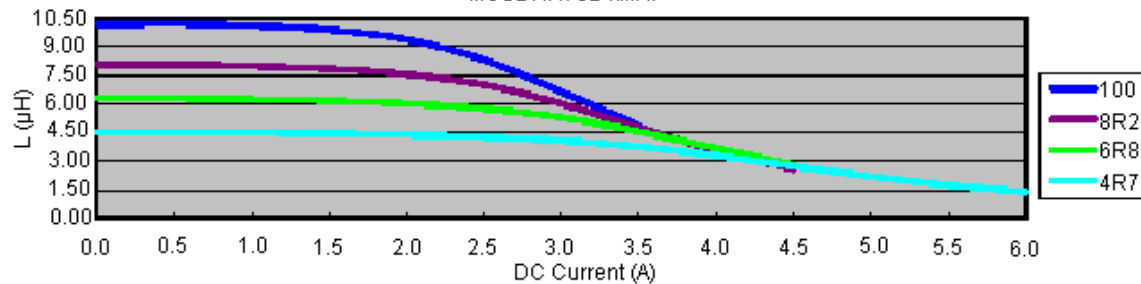

MCSDRH73B-xMHF

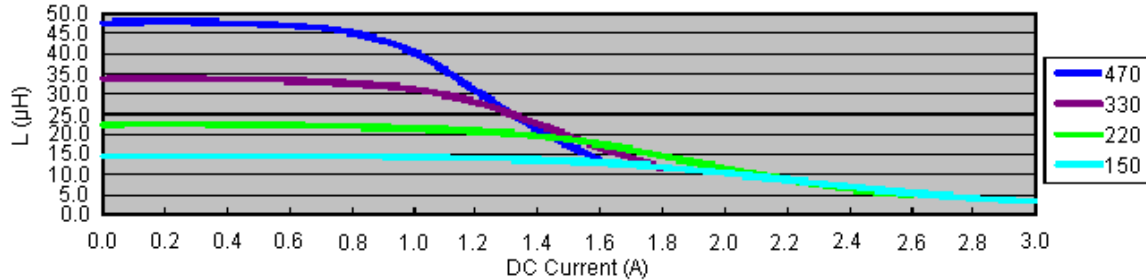

MCSDRH73B-xMHF

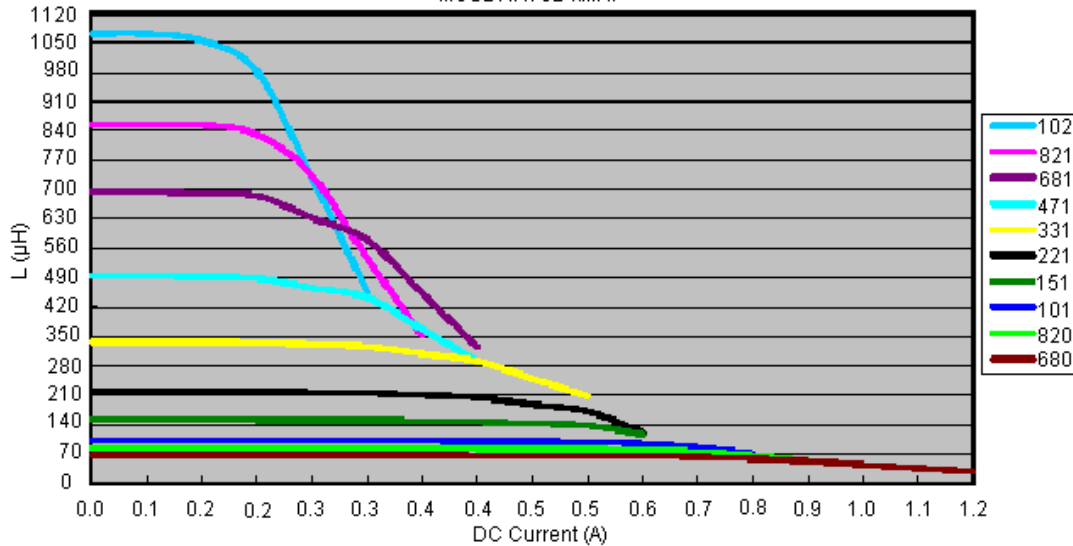

<http://www.farnell.com>
<http://www.newark.com>
<http://www.cpc.co.uk>



SMD Power Inductors



Inductance vs. Current

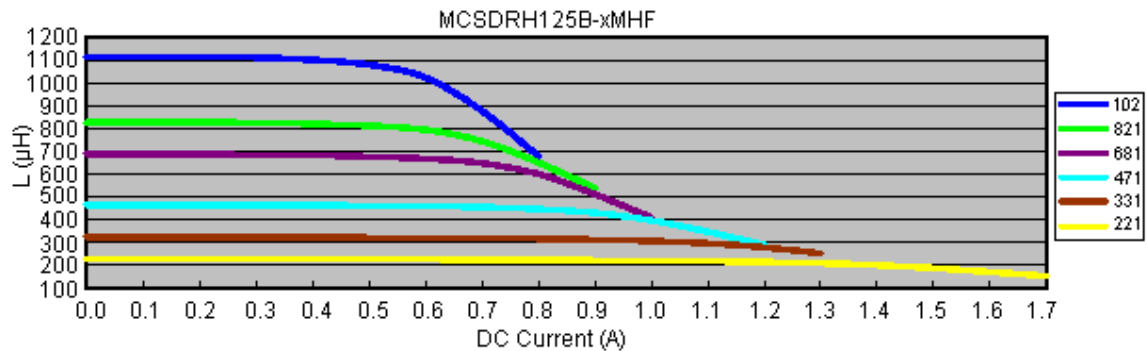
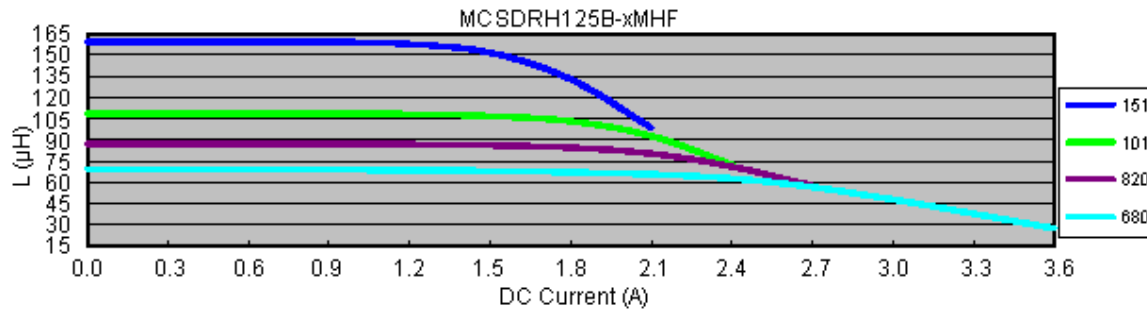
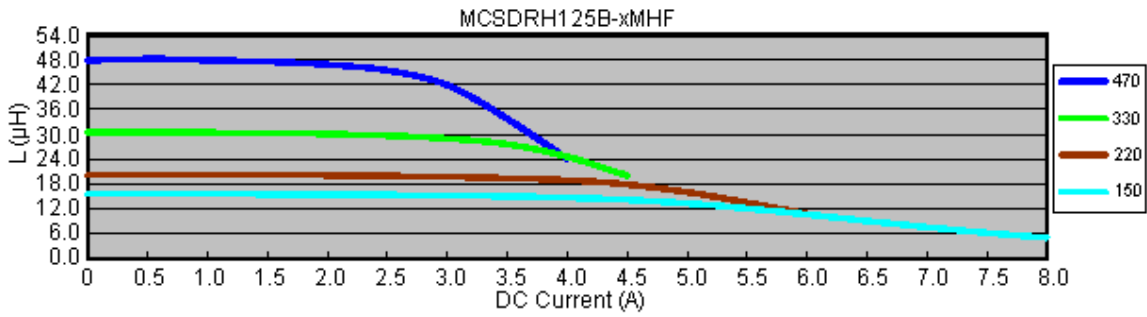
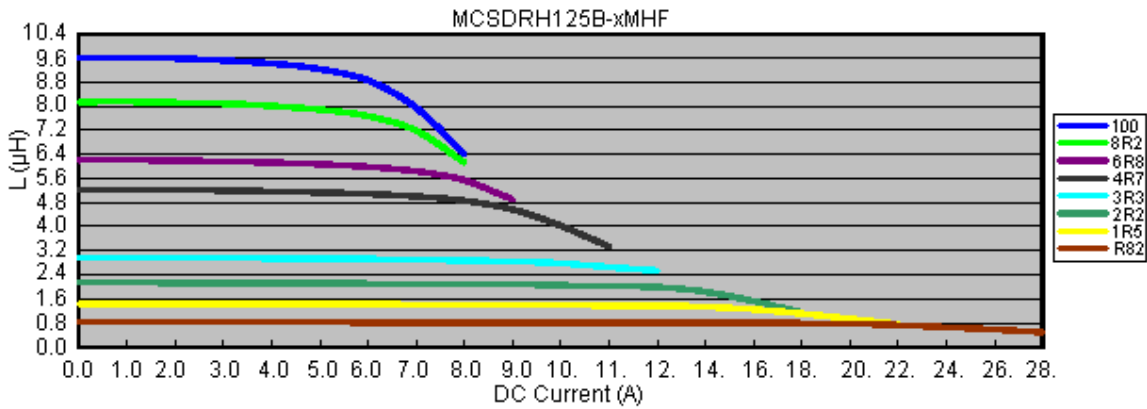

Disclaimer This data sheet and its contents (the "Information") belong to the Premier Farnell Group (the "Group") or are licensed to it. No licence is granted for the use of it other than for information purposes in connection with the products to which it relates. No licence of any intellectual property rights is granted. The Information is subject to change without notice and replaces all data sheets previously supplied. The Information supplied is believed to be accurate but the Group assumes no responsibility for its accuracy or completeness, any error in or omission from it or for any use made of it. Users of this data sheet should check for themselves the Information and the suitability of the products for their purpose and not make any assumptions based on information included or omitted. Liability for loss or damage resulting from any reliance on the Information or use of it (including liability resulting from negligence or where the Group was aware of the possibility of such loss or damage arising) is excluded. This will not operate to limit or restrict the Group's liability for death or personal injury resulting from its negligence. SPC Multicomp is the registered trademark of the Group. © Premier Farnell plc 2010.

<http://www.farnell.com>
<http://www.newark.com>
<http://www.cpc.co.uk>

