

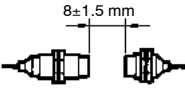

Allows Wireless Transmission of ON/OFF Signals from Input Devices and Power to Input Devices

- Use the electromagnetic coupler to transmit input signals to the B7A Output Unit
- Supplies power to the B7A Input Unit, which means it does not require an independent power supply
- Wireless signal and power transmission through a nonmetal object (such as plastic or glass) is possible



Ordering Information

Classification	Appearance	Transmission distance (couplers)	I/O delay	Part number
Stationary Unit	M30 	 8±1.5 mm (0.32 in ±0.06 in)	Typical: 19.2 ms Max.: 31 ms	B7AP-S1 (See Note.)
Moving Unit	M30 			B7AP-M1

Note: The B7AP-S1 Power Coupler has a gauge that is used to adjust the transmission distance between the B7AP-S1 and B7AP-M1 Power Couplers.

■ B7A MODELS

Applicable B7A Link Terminal	Max. I/O points (See Note 1.)	Applicable input device (See Note 3.)	Part number
B7A-R6B31	(See Note 2.)	---	B7AP-S1
B7A-R6C31			
B7A-R6F31			
B7A-R6G31			
B7A-R6A52 (See Note 4.)			
B7A-R6A33			
B7A-R3A33			
B7AS-R6B31			
B7AM-6BS (See Note 4.)			
B7A-T6□1	10 (16)	Two-wire sensor, contact	B7AP-M1
B7A-T6D2	10 (16)	Contact	
B7A-T6E3	10 (16)		
B7A-T3E3	10 (16)		
B7AS-T6B1	10 (16)	Two-wire sensor, contact	
B7AM-6BS	10 (16)		

- Note: 1. The maximum I/O points refers the maximum I/O points handled simultaneously by the B7A Input and Output Units. Figures in parentheses indicate the maximum I/O points handled simultaneously by the B7A Input and Output Units each connected with an independent power supply. Refer to *Power Supplies* in Operation Section of this data sheet.
2. The maximum I/O points are the same as the maximum input points of the B7A Input Unit connected to the B7AP-M1.
3. PLCs and three-wire sensors can be connected only if the B7A Input and Output Units are each connected with an independent power supply. Refer to *Power Supplies* in Operation Section of this data sheet.
4. Set the error processing to the LOAD-OFF mode.

Specifications

■ COMMUNICATIONS SPECIFICATIONS

Communication method	Unidirectional, time-division multiplex
Transmission distance (couplers)	8±1.5 mm (0.32 in ± 0.06 in)
Transmission distance (B7A)	100 m max. (328 ft) See Note 1.
I/O delay	Typical: 19.2 ms; 31 ms max.
Minimum coupler interfacing time	0.3 s (See Note 2.)
Minimum distance between Power Couplers mounted in parallel	60 mm (2.36 in)

- Note: 1. The value is for the case where a power supply is provided only for the B7AP-S1.
2. Minimum coupler interfacing time is the minimum time required for signal and power transmission between the B7AP-S1 and B7AP-M1 Power Couplers.

■ CHARACTERISTICS

Part number	B7AP-S1		B7AP-M1
Power supply voltage	24 VDC $\pm 10\%$		---
Current consumption	300 mA		---
Insulation resistance	100 M Ω min. (at 500 VDC) between each lead wire and external parts		
Dielectric strength	1,000 VAC, 50/60 Hz for 1 min between each lead wire and external parts		
Noise immunity	Noise level: 1.5 kV; pulse width: 100 ns to 1 μ s (on transmission line due to coupling)		
Vibration resistance	10 to 55 Hz, 1.5-mm double amplitude		
Shock resistance	500 m/s ² (1640.4 ft/sec ²) approx. 50G		
Ambient temperature	Operating	-10°C to 55°C (14°F to 131°F) with no icing or condensation	
	Storage	-25°C to 65°C (-13°F to 149°F) with no icing or condensation	
Ambient humidity	Operating	35% to 95% (with no condensation)	
Cable pulling strength	49 N (5 kgf) (11 lbs)		
Nut tightening strength	39 N \cdot m (400 kgf \cdot cm) (28.7 ft \cdot lbf)		
Enclosure rating	IEC IP67		
Maximum cable length	2 m (78.7 in)		
Weight	Approx. 300 g (10.58 oz)		Approx. 230 g (8.11 oz)
EMC	Radiated Emissions: EN55022 class A Radiated Immunity: prEN50082-2 Electrostatic Discharge: prEN50082-2 Burst Transients: prEN50082-2		
Approved standards	UL508 Conforms to EN50081-2, EN50082-2		

■ MOVING UNIT SPECIFICATIONS

Output voltage	12 VDC $\pm 10\%$
Output current	38 mA

Note: Use the Moving Unit so that the total current consumption of all input devices is 38 mA max. if power is supplied to the input devices through the Moving Unit.

Engineering Data

■ TRANSMISSION RANGE (REFERENCE)

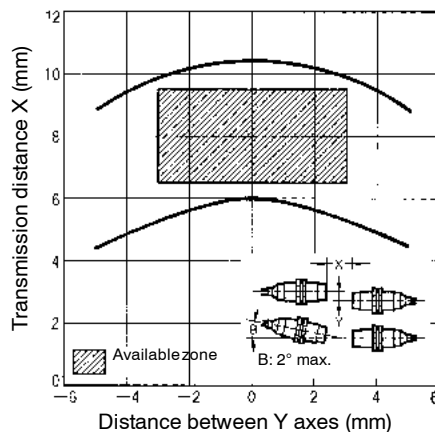

Operation

CONNECTION

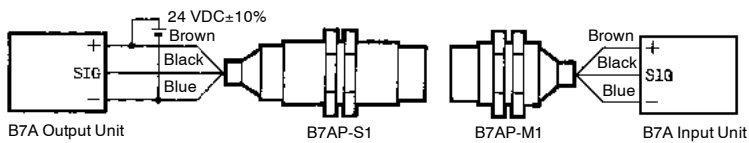

POWER SUPPLIES

Signal and Power Transmission (with Power Supplied to B7AP-S1)

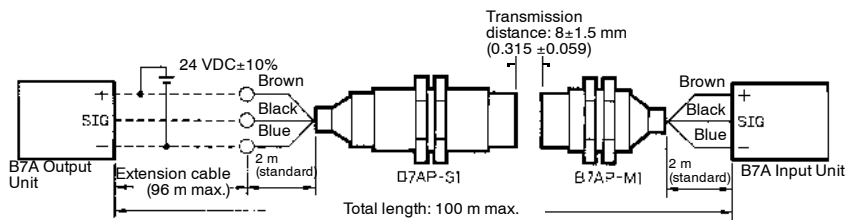

- Note:
1. The thickness of the extension cable for the B7AP-S1 Power Coupler must be 0.75 mm^2 min.
 2. No extension cable can be connected to the B7AP-M1 Power Coupler. Use the original 2-m cable connected to the B7AP-M1 Power Coupler.
 3. Refer to *page 2, B7A Models* for the maximum input points of the B7A Input Unit.
 4. No PLC or three-wire sensor can be connected to the B7A Input Unit.

Signal Transmission Only (with Power Supplied to B7AP-S1 and B7AP-M1)

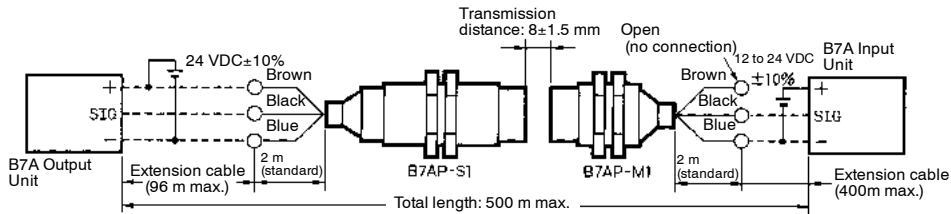

- Note:
1. The thickness of the extension cable for the B7AP-S1 or B7AP-M1 Power Coupler must be 0.75 mm^2 min.
 2. For transmitting signals only, the brown lead wire of the B7AP-M1 Power Coupler must not be used. Insulate the brown lead wire with insulation tape so that the brown wire will not come in contact with any lead wire.
 3. The maximum input points of the B7A Input Unit are available.
 4. PLCs and three-wire sensors can be connected to the B7A Input Unit.

INDICATORS

Indicators		Function
Power indicator (B7AP-S1)	Lit	Lit when power is supplied to the Power Coupler.
	Not lit	Not lit when power is not supplied to the Power Coupler.
Operation indicator (B7AP-M1)	Lit	Lit when the B7AP-M1 and B7AP-S1 Power Couplers are properly set for wireless signal or power transmission at a transmission distance of 8 ± 1.5 mm. (0.32 ± 0.06).
	Not lit	Not lit when the B7AP-M1 and B7AP-S1 Power Couplers are not properly set for wireless signal or power transmission, or the B7AP-M1 Power Coupler has excessive loads.

B7AP-S1

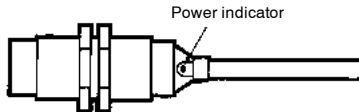

B7AP-M1

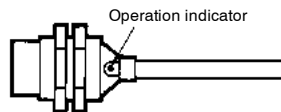

Dimensions

Unit: mm (inch)

B7AP-S1

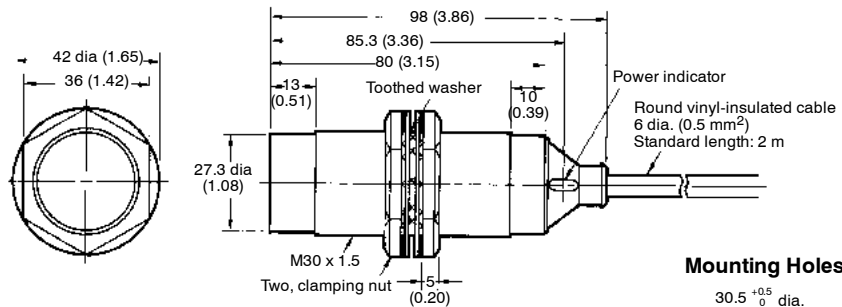
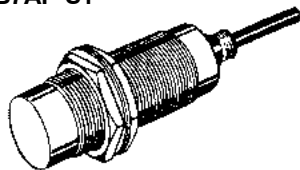

Mounting Holes

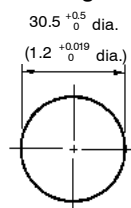

B7AP-M1

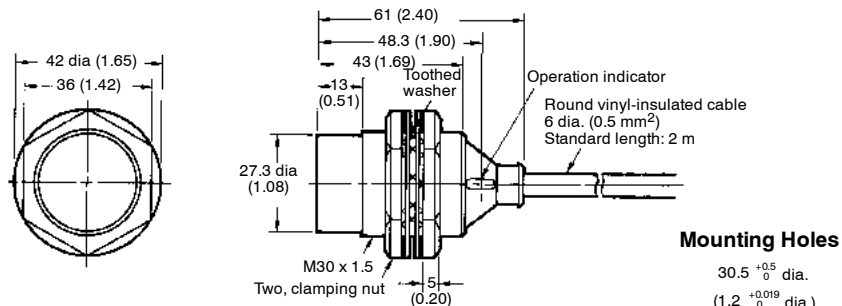
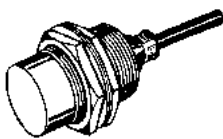

Mounting Holes

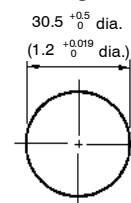

Precautions

GENERAL PRECAUTIONS

Be careful when touching the B7AP-S1 Power Coupler during operation because the surface temperature of the B7AP-S1 Power Coupler will rise approximately 20°C after the B7AP-S1 Power Coupler starts power transmission. The surface temperature varies with the load of the sensing device connected to the B7AP-M1 Power Coupler and the transmission distance.

HANDLING

Use the B7AP-S1 and B7AP-M1 Power Couplers with the available B7A Link Terminals. Refer to *page 2, B7A Models*. The M7E-12□□ Display Unit, M7E-20□□ Display Unit, and B7A Link Terminals with an I/O delay of 3 ms cannot be used with the B7AP-S1 or B7AP-M1 Power Coupler.

Use the LOAD-OFF model for the B7A Output Unit to be connected to the B7AP-S1. When using a model that allows selection of error processing, set to the LOAD-OFF mode. This turns OFF signals right before an occurrence of a transmission error and prevents unexpected signal transmission when the transmission error is cleared.

Separate the Power Couplers 8±1.5 mm min. away from each other. The distance between the Power Couplers on standby must be 30 mm or more.

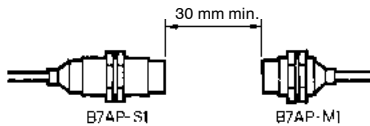

Do not supply power to the B7AP-S1 or B7AP-M1 Power Coupler while connecting the Power Couplers to the B7A Link Terminals. Connect the Power Couplers to the B7A Link Terminals correctly, otherwise the internal circuits of the Power Couplers may be damaged.

The SIG terminal must not contact with the power supply terminals, otherwise the internal elements may be damaged and normal transmission may not be possible.

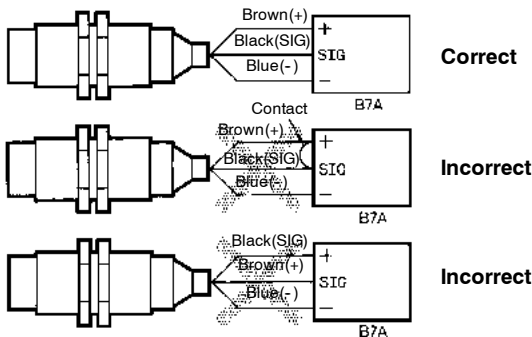

Wire the cables of the B7AP-S1 and B7AP-M1 Power Couplers through independent metal conduits to prevent the Power Couplers from being influenced by noise if there are power or high-tension lines nearby. Test the Power Couplers and make sure that the Power Couplers operate normally before they are put in actual operation.

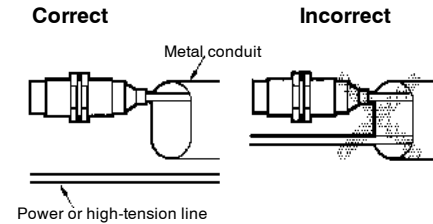

Do not subject the head of the B7AP-S1 or B7AP-M1 Power Coupler to excessive shock with hard objects.

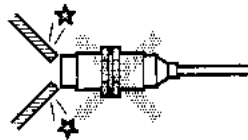

Do not use the B7AP-S1 or B7AP-M1 Power Coupler outdoors unless it is properly protected.

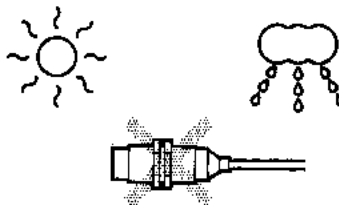

The B7AP-S1 and B7AP-M1 Power Couplers are products meeting the requirements of IP67. The B7AP-S1 or B7AP-M1 Power Coupler cannot be, however, used in water or oil.

Keep the heads of the B7AP-S1 and B7AP-M1 Power Couplers free from dust, otherwise improper signal or power transmission may result between the Power Couplers.

MOUNTING

Use nuts and serrated toothed washers and tighten the nuts to mount the B7AP-S1 and B7AP-M1 Power Couplers. The tightening torque applied to each of the nuts must be 39 N • m (28.7 ft • lbf) maximum. The mounting position will change and improper signal or power transmission may result between the Power Couplers if the nuts are not tightened properly.

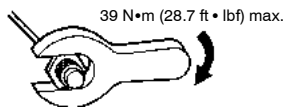

■ TRANSMISSION DISTANCE FOR STABLE SIGNAL AND POWER TRANSMISSION

The B7AP-S1 Power Coupler has a gauge that is used to adjust the transmission distance between the B7AP-S1 and B7AP-M1 Power Couplers. Use the gauge to adjust the transmission distance to 8 mm, make sure that the green operation indicator of the B7AP-M1 Power Coupler is lit, and the B7A Output Unit has no error output before operating the Power Couplers.

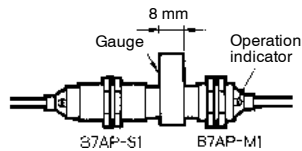

■ MONITORING TRANSMISSION STATUS

Judge from the power supply/error indicator and error output of the B7A Output Unit whether the B7AP-S1 and B7AP-M1 Power Couplers are facing each other correctly.

The error output of the B7A Output Unit will be ON when the B7AP-S1 and B7AP-M1 Power Couplers are not facing each other correctly.

■ MINIMUM DISTANCE BETWEEN POWER COUPLERS MOUNTED IN PARALLEL

When mounting the B7AP-S1 and B7AP-M1 Power Couplers in parallel, refer to the following table. Keep at least the specified minimum distance between adjacent Power Couplers for proper heat radiation by considering the temperature rise (approximately 20°C) of the B7AP-S1 Power Couplers in operation.

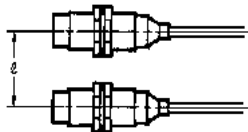

Item	B7AP-S1	B7AP-M1
l	60 mm (2.36 in)	60 mm (2.36 in)

■ EFFECTS OF SURROUNDING METAL

The B7AP Power Coupler may malfunction when affected by surrounding metal. When mounting the B7AP within a metal panel, ensure that the clearances given in the following table are maintained. Be sure to check in advance that the B7AP operates correctly.

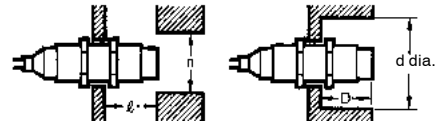

Item	B7AP-S1	B7AP-M1
l	20 mm (0.79 in)	20 mm (0.79 in)
d	60 mm dia. (2.36 in)	60 mm dia. (2.36 in)
D	20 mm (0.79 in)	20 mm (0.79 in)
n	60 mm (2.36 in)	60 mm (2.36 in)

■ MAINTENANCE

Regularly check these items for the stable operation of the B7AP-S1 and B7AP-M1 Power Couplers:

- The mounting positions and the tightening of the mounting nuts.
- The tightening, contacts, and breaking of the lead wires.
- Dust accumulation on the heads.
- The ambient operating temperature and other operating conditions.
- The transmission distance.

NOTE: DIMENSIONS SHOWN ARE IN MILLIMETERS. To convert millimeters to inches divide by 25.4.

OMRON[®]

OMRON ELECTRONICS LLC

One East Commerce Drive
Schaumburg, IL 60173

1-800-55-OMRON

OMRON ON-LINE

Global - <http://www.omron.com>
USA - <http://www.omron.com/oei>
Canada - <http://www.omron.com/oci>

OMRON CANADA, INC.

885 Milner Avenue
Scarborough, Ontario M1B 5V8

416-286-6465