

## 1.2 W audio power amplifier with active low standby mode

### Features

- Operating range from  $V_{CC} = 2.2\text{ V}$  to  $5.5\text{ V}$
- $1.2\text{ W}$  output power @  $V_{CC} = 5\text{ V}$ , THD = 1%,  $F = 1\text{ kHz}$ , with  $8\Omega$  load
- Ultra-low consumption in standby mode (10 nA)
- 62 dB PSRR at 217 Hz in grounded mode
- Near-zero pop and click
- Ultra-low distortion (0.1%)
- Unity gain stable
- Available in 9-bump flip-chip, miniSO-8 and DFN8 packages

### Applications

- Mobile phones (cellular / cordless)
- Laptop / notebook computers
- PDAs
- Portable audio devices

### Description

The TS4990 is designed for demanding audio applications such as mobile phones to reduce the number of external components.

This audio power amplifier is capable of delivering  $1.2\text{ W}$  of continuous RMS output power into an  $8\Omega$  load at  $5\text{ V}$ .

An externally controlled standby mode reduces the supply current to less than  $10\text{ nA}$ . It also includes an internal thermal shutdown protection.

The unity-gain stable amplifier can be configured by external gain setting resistors.

TS4990IJT/TS4990EIJT - Flip-chip 9 bumps

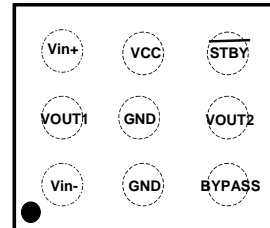

TS4990IST - MiniSO-8

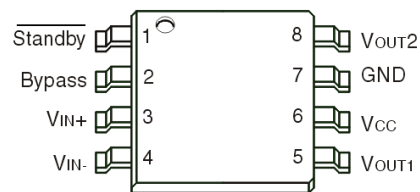

TS4990IQT - DFN8

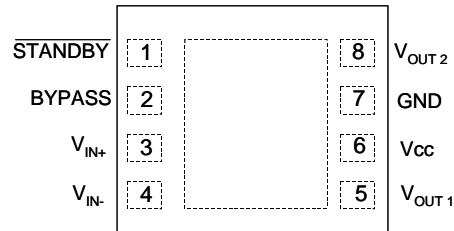

TS4990ID/TS4990IDT - SO-8

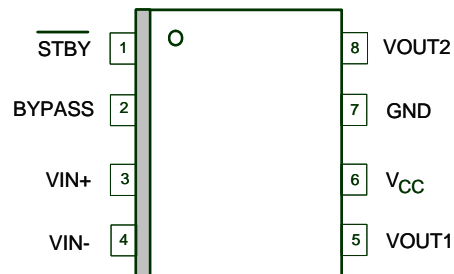

# Contents

<b>1</b>	<b>Absolute maximum ratings and operating conditions</b>	<b>3</b>
<b>2</b>	<b>Typical application schematics</b>	<b>4</b>
<b>3</b>	<b>Electrical characteristics</b>	<b>5</b>
<b>4</b>	<b>Application information</b>	<b>18</b>
4.1	BTL configuration principle	18
4.2	Gain in a typical application	18
4.3	Low and high frequency response	18
4.4	Power dissipation and efficiency	19
4.5	Decoupling of the circuit	20
4.6	Wake-up time ( $t_{WU}$ )	21
4.7	Shutdown time	21
4.8	Pop performance	22
4.9	Application example: differential input, BTL power amplifier	22
<b>5</b>	<b>Package information</b>	<b>24</b>
5.1	Flip-chip package information	24
5.2	MiniSO-8 package information	27
5.3	DFN8 package information	28
5.4	SO-8 package information	29
<b>6</b>	<b>Ordering information</b>	<b>30</b>
<b>7</b>	<b>Revision history</b>	<b>31</b>

# 1 Absolute maximum ratings and operating conditions

**Table 1. Absolute maximum ratings (AMR)**

Symbol	Parameter	Value	Unit
$V_{CC}$	Supply voltage <sup>(1)</sup>	6	V
$V_{in}$	Input voltage <sup>(2)</sup>	GND to $V_{CC}$	V
$T_{oper}$	Operating free-air temperature range	-40 to + 85	°C
$T_{stg}$	Storage temperature	-65 to +150	°C
$T_j$	Maximum junction temperature	150	°C
$R_{thja}$	Thermal resistance junction to ambient		
	Flip chip <sup>(3)</sup>	250	°C/W
	MiniSO-8	215	
DFN8	120		
$P_{diss}$	Power dissipation	Internally limited	
ESD	HBM: Human body model <sup>(4)</sup>	2	kV
	MM: Machine model <sup>(5)</sup>	200	V
	Latch-up immunity	200	mA
	Lead temperature (soldering, 10sec)	250	°C
	Lead temperature (soldering, 10sec) for lead-free version	260	

- All voltage values are measured with respect to the ground pin.
- The magnitude of the input signal must never exceed  $V_{CC} + 0.3 \text{ V} / \text{GND} - 0.3 \text{ V}$ .
- The device is protected in case of over temperature by a thermal shutdown active at 150° C.
- Human body model: A 100 pF capacitor is charged to the specified voltage, then discharged through a 1.5 kΩ resistor between two pins of the device. This is done for all couples of connected pin combinations while the other pins are floating.
- Machine model: A 200 pF capacitor is charged to the specified voltage, then discharged directly between two pins of the device with no external series resistor (internal resistor < 5 Ω). This is done for all couples of connected pin combinations while the other pins are floating.

**Table 2. Operating conditions**

Symbol	Parameter	Value	Unit
$V_{CC}$	Supply voltage	2.2 to 5.5	V
$V_{icm}$	Common mode input voltage range	1.2V to $V_{CC}$	V
$V_{STBY}$	Standby voltage input:		
	Device ON Device OFF	$1.35 \leq V_{STBY} \leq V_{CC}$ $\text{GND} \leq V_{STBY} \leq 0.4$	V
$R_L$	Load resistor	$\geq 4$	Ω
$T_{SD}$	Thermal shutdown temperature	150	°C
$R_{thja}$	Thermal resistance junction to ambient		
	Flip-chip <sup>(1)</sup>	100	°C/W
	MiniSO-8	190	
DFN8 <sup>(2)</sup>	40		

- This thermal resistance is reached with a 100 mm<sup>2</sup> copper heatsink surface.
- When mounted on a 4-layer PCB.

## 2 Typical application schematics

Figure 1. Typical application schematics

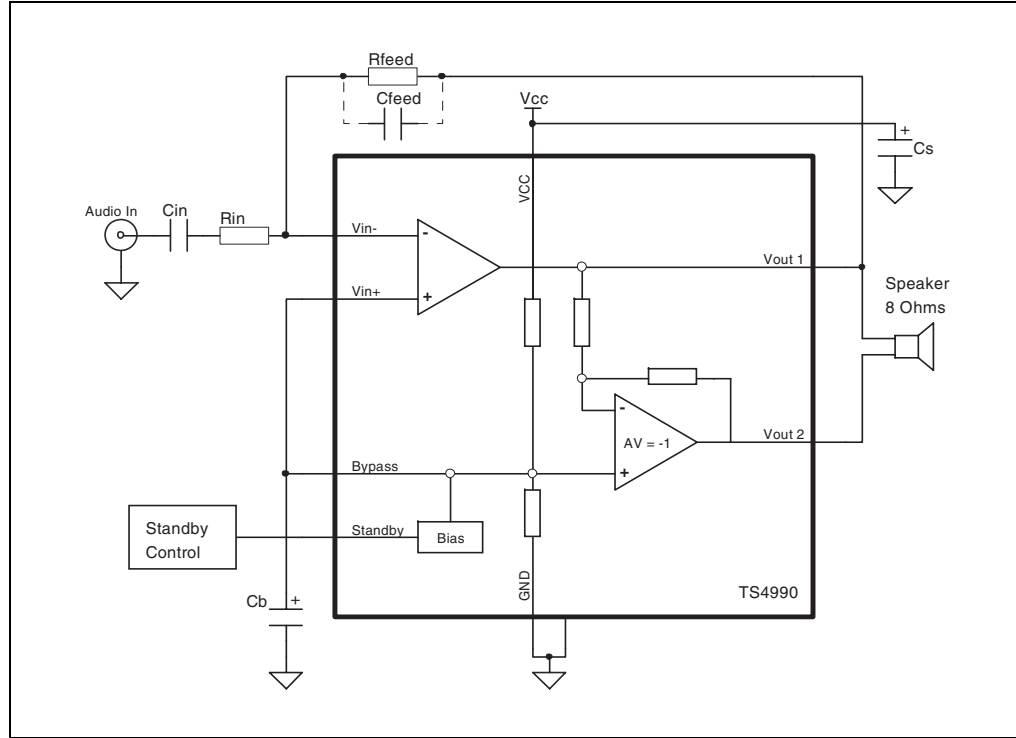

Table 3. Component descriptions

Component	Functional description
$R_{in}$	Inverting input resistor that sets the closed loop gain in conjunction with $R_{feed}$ . This resistor also forms a high pass filter with $C_{in}$ ( $F_c = 1 / (2 \times \pi \times R_{in} \times C_{in})$ ).
$C_{in}$	Input coupling capacitor that blocks the DC voltage at the amplifier input terminal.
$R_{feed}$	Feed back resistor that sets the closed loop gain in conjunction with $R_{in}$ .
$C_s$	Supply bypass capacitor that provides power supply filtering.
$C_b$	Bypass pin capacitor that provides half supply filtering.
$C_{feed}$	Low pass filter capacitor allowing to cut the high frequency (low pass filter cut-off frequency $1 / (2 \times \pi \times R_{feed} \times C_{feed})$ ).
$A_V$	Closed loop gain in BTL configuration = $2 \times (R_{feed} / R_{in})$ .
Exposed pad	DFN8 exposed pad is electrically connected to pin 7. See <a href="#">DFN8 package information on page 28</a> for more information.

### 3 Electrical characteristics

**Table 4. Electrical characteristics when  $V_{CC} = +5\text{ V}$ ,  $GND = 0\text{ V}$ ,  $T_{amb} = 25^\circ\text{C}$  (unless otherwise specified)**

Symbol	Parameter	Min.	Typ.	Max.	Unit
$I_{CC}$	Supply current No input signal, no load		3.7	6	mA
$I_{STBY}$	Standby current <sup>(1)</sup> No input signal, $V_{STBY} = GND$ , $R_L = 8\Omega$		10	1000	nA
$V_{oo}$	Output offset voltage No input signal, $R_L = 8\Omega$		1	10	mV
$P_{out}$	Output power THD = 1% max, $F = 1\text{kHz}$ , $R_L = 8\Omega$	0.9	1.2		W
THD + N	Total harmonic distortion + noise $P_{out} = 1W_{rms}$ , $A_V = 2$ , $20\text{Hz} \leq F \leq 20\text{kHz}$ , $R_L = 8\Omega$		0.2		%
PSRR	Power supply rejection ratio <sup>(2)</sup> $R_L = 8\Omega$ , $A_V = 2$ , $V_{ripple} = 200\text{mV}_{pp}$ , input grounded $F = 217\text{Hz}$ $F = 1\text{kHz}$	55 55	62 64		dB
$t_{WU}$	Wake-up time ( $C_b = 1\mu\text{F}$ )		90	130	ms
$t_{STBY}$	Standby time ( $C_b = 1\mu\text{F}$ )		10		$\mu\text{s}$
$V_{STBYH}$	Standby voltage level high			1.3	V
$V_{STBYL}$	Standby voltage level low			0.4	V
$\phi_M$	Phase margin at unity gain $R_L = 8\Omega$ , $C_L = 500\text{pF}$		65		Degrees
GM	Gain margin $R_L = 8\Omega$ , $C_L = 500\text{pF}$		15		dB
GBP	Gain bandwidth product $R_L = 8\Omega$		1.5		MHz
$R_{OUT-GND}$	Resistor output to GND ( $V_{STBY} \leq V_{STBYL}$ ) $V_{out1}$ $V_{out2}$		3 43		k $\Omega$

- Standby mode is active when  $V_{STBY}$  is tied to GND.
- All PSRR data limits are guaranteed by production sampling tests.  
Dynamic measurements -  $20 \cdot \log(\text{rms}(V_{out})/\text{rms}(V_{ripple}))$ .  $V_{ripple}$  is the sinusoidal signal superimposed upon  $V_{CC}$ .

**Table 5. Electrical characteristics when  $V_{CC} = +3.3\text{ V}$ ,  $GND = 0\text{ V}$ ,  $T_{amb} = 25^\circ\text{C}$  (unless otherwise specified)**

Symbol	Parameter	Min.	Typ.	Max.	Unit
$I_{CC}$	Supply current No input signal, no load		3.3	6	mA
$I_{STBY}$	Standby current <sup>(1)</sup> No input signal, $V_{STBY} = GND$ , $R_L = 8\Omega$		10	1000	nA
$V_{oo}$	Output offset voltage No input signal, $R_L = 8\Omega$		1	10	mV
$P_{out}$	Output power THD = 1% max, $F = 1\text{kHz}$ , $R_L = 8\Omega$	375	500		mW
THD + N	Total harmonic distortion + noise $P_{out} = 400\text{mW}_{rms}$ , $A_V = 2$ , $20\text{Hz} \leq F \leq 20\text{kHz}$ , $R_L = 8\Omega$		0.1		%
PSRR	Power supply rejection ratio <sup>(2)</sup> $R_L = 8\Omega$ , $A_V = 2$ , $V_{ripple} = 200\text{mV}_{pp}$ , input grounded $F = 217\text{Hz}$ $F = 1\text{kHz}$	55 55	61 63		dB
$t_{WU}$	Wake-up time ( $C_b = 1\mu\text{F}$ )		110	140	ms
$t_{STBY}$	Standby time ( $C_b = 1\mu\text{F}$ )		10		$\mu\text{s}$
$V_{STBYH}$	Standby voltage level high			1.2	V
$V_{STBYL}$	Standby voltage level low			0.4	V
$\Phi_M$	Phase margin at unity gain $R_L = 8\Omega$ , $C_L = 500\text{pF}$		65		Degrees
GM	Gain margin $R_L = 8\Omega$ , $C_L = 500\text{pF}$		15		dB
GBP	Gain bandwidth product $R_L = 8\Omega$		1.5		MHz
$R_{OUT-GND}$	Resistor output to GND ( $V_{STBY} \leq V_{STBYL}$ ) $V_{out1}$ $V_{out2}$		4 44		k $\Omega$

- Standby mode is active when  $V_{STBY}$  is tied to GND.
- All PSRR data limits are guaranteed by production sampling tests.  
Dynamic measurements -  $20 \cdot \log(\text{rms}(V_{out})/\text{rms}(V_{ripple}))$ .  $V_{ripple}$  is the sinusoidal signal superimposed upon  $V_{CC}$ .

**Table 6. Electrical characteristics when  $V_{CC} = 2.6V$ ,  $GND = 0V$ ,  $T_{amb} = 25^{\circ}C$  (unless otherwise specified)**

Symbol	Parameter	Min.	Typ.	Max.	Unit
$I_{CC}$	Supply current No input signal, no load		3.1	6	mA
$I_{STBY}$	Standby current <sup>(1)</sup> No input signal, $V_{STBY} = GND$ , $R_L = 8\Omega$		10	1000	nA
$V_{oo}$	Output offset voltage No input signal, $R_L = 8\Omega$		1	10	mV
$P_{out}$	Output power THD = 1% max, $F = 1kHz$ , $R_L = 8\Omega$	220	300		mW
THD + N	Total harmonic distortion + noise $P_{out} = 200mW_{rms}$ , $A_V = 2$ , $20Hz \leq F \leq 20kHz$ , $R_L = 8\Omega$		0.1		%
PSRR	Power supply rejection ratio <sup>(2)</sup> $R_L = 8\Omega$ , $A_V = 2$ , $V_{ripple} = 200mV_{pp}$ , input grounded $F = 217Hz$ $F = 1kHz$	55 55	60 62		dB
$t_{WU}$	Wake-up time ( $C_b = 1\mu F$ )		125	150	ms
$t_{STBY}$	Standby time ( $C_b = 1\mu F$ )		10		$\mu s$
$V_{STBYH}$	Standby voltage level high			1.2	V
$V_{STBYL}$	Standby voltage level low			0.4	V
$\phi_M$	Phase margin at unity gain $R_L = 8\Omega$ , $C_L = 500pF$		65		Degrees
GM	Gain margin $R_L = 8\Omega$ , $C_L = 500pF$		15		dB
GBP	Gain bandwidth product $R_L = 8\Omega$		1.5		MHz
$R_{OUT-GND}$	Resistor output to GND ( $V_{STBY} \leq V_{STBYL}$ ) $V_{out1}$ $V_{out2}$		6 46		k $\Omega$

- Standby mode is active when  $V_{STBY}$  is tied to GND.
- All PSRR data limits are guaranteed by production sampling tests.  
Dynamic measurements -  $20 \cdot \log(\text{rms}(V_{out})/\text{rms}(V_{ripple}))$ .  $V_{ripple}$  is the sinusoidal signal superimposed upon  $V_{CC}$ .

Figure 2. Open loop frequency response

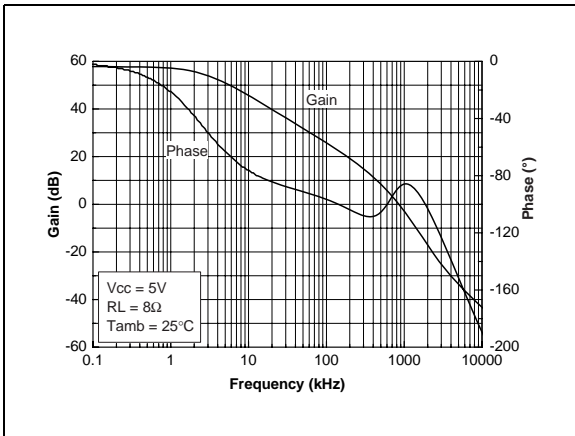

Figure 3. Open loop frequency response

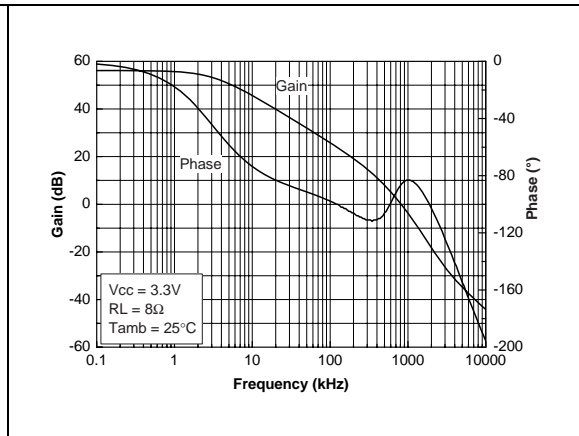

Figure 4. Open loop frequency response

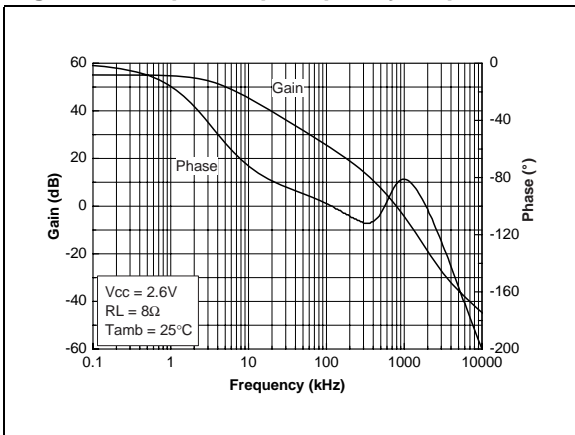

Figure 5. Open loop frequency response

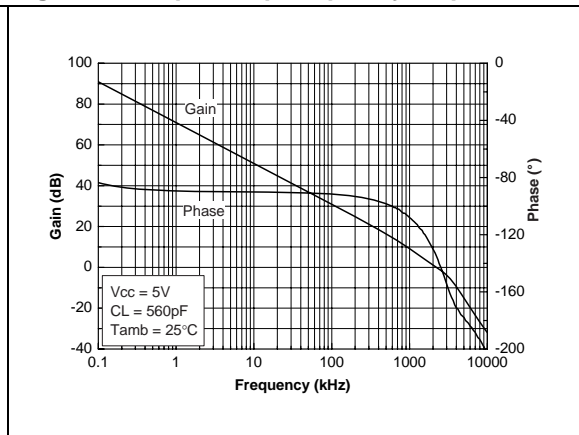

Figure 6. Open loop frequency response

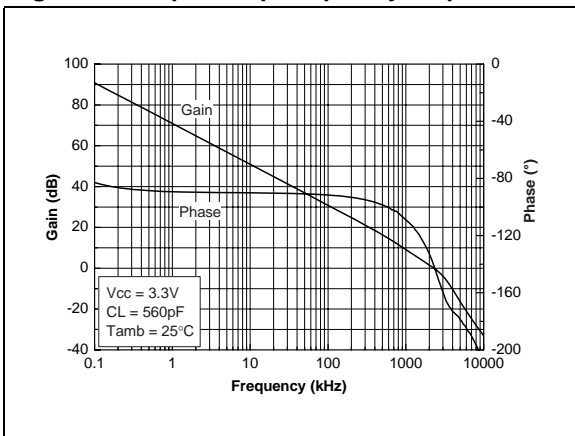

Figure 7. Open loop frequency response

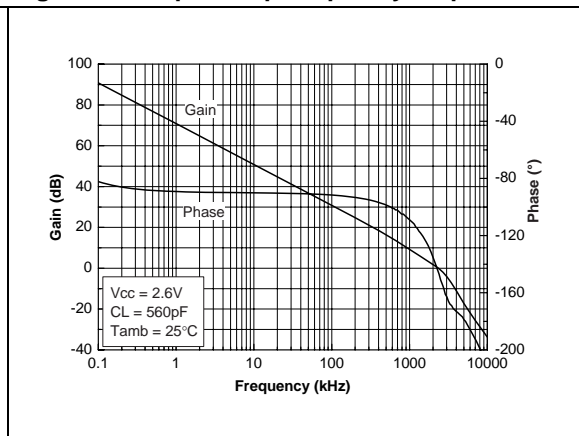



Figure 8. PSRR vs. power supply

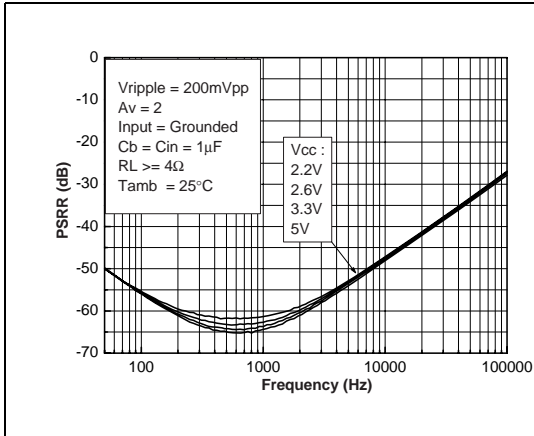

Figure 9. PSRR vs. power supply

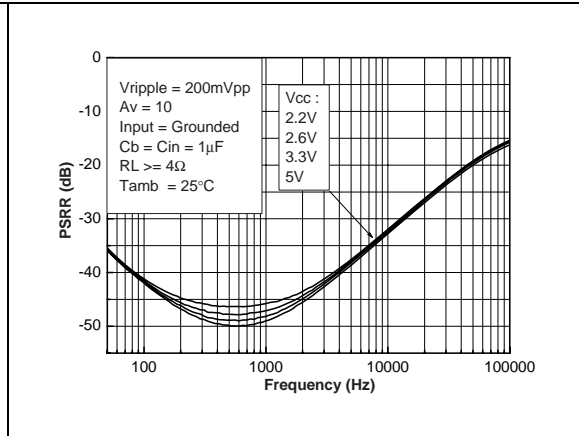

Figure 10. PSRR vs. power supply

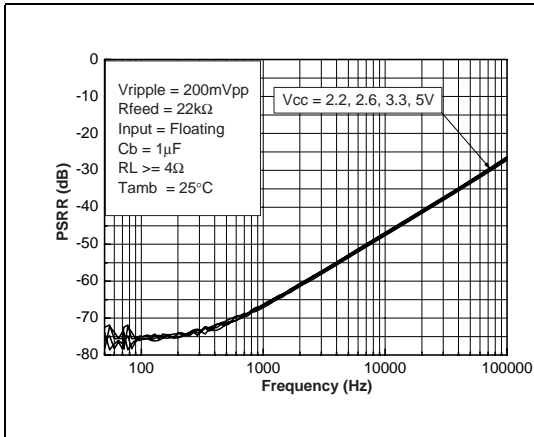

Figure 11. PSRR vs. power supply

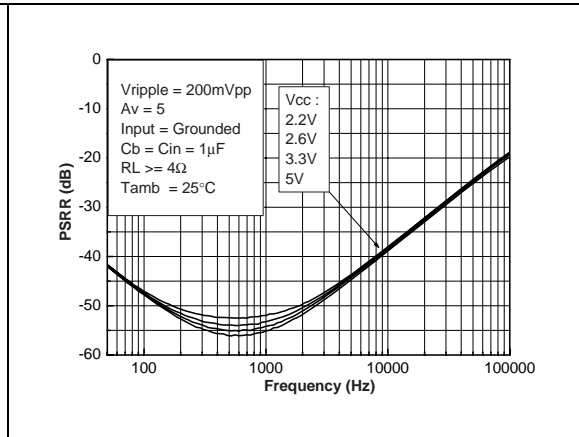

Figure 12. PSRR vs. power supply

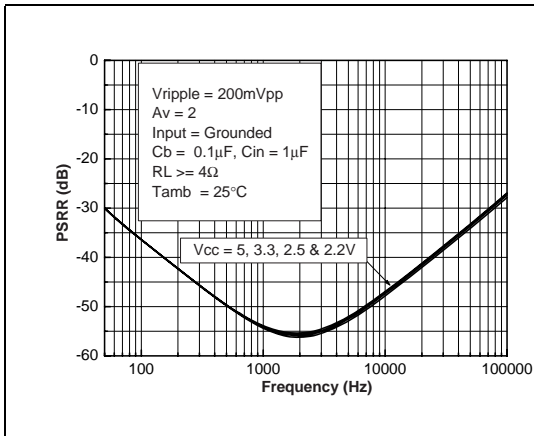

Figure 13. PSRR vs. power supply

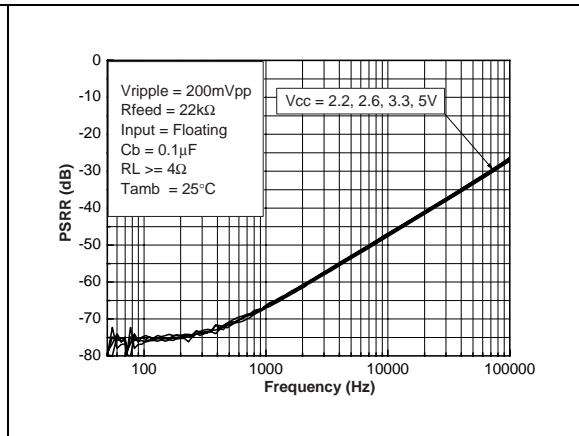

Figure 14. PSRR vs. DC output voltage

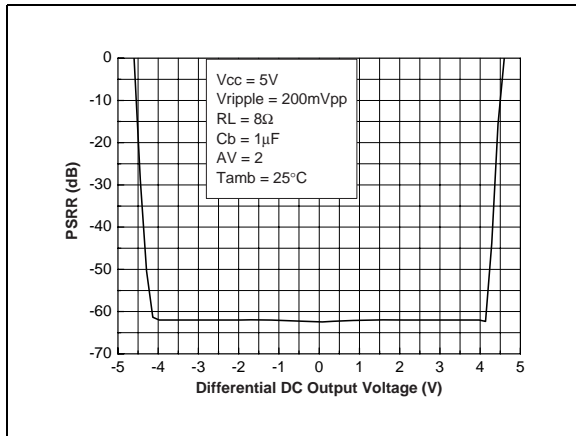

Figure 15. PSRR vs. DC output voltage

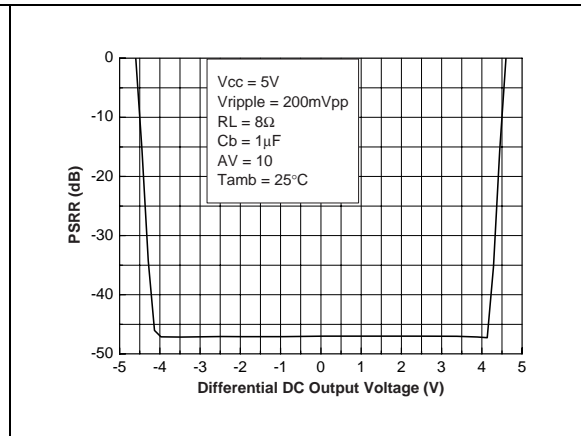

Figure 16. PSRR vs. DC output voltage

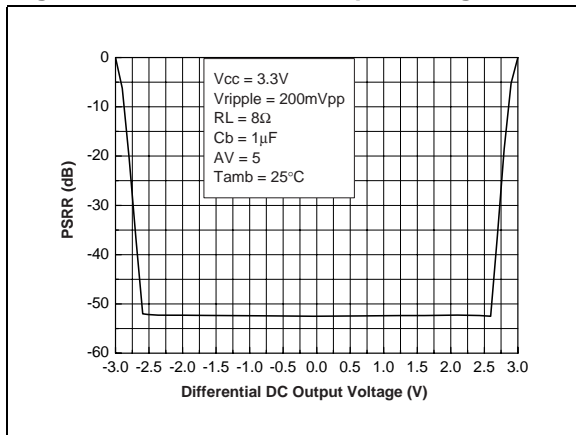

Figure 17. PSRR vs. DC output voltage

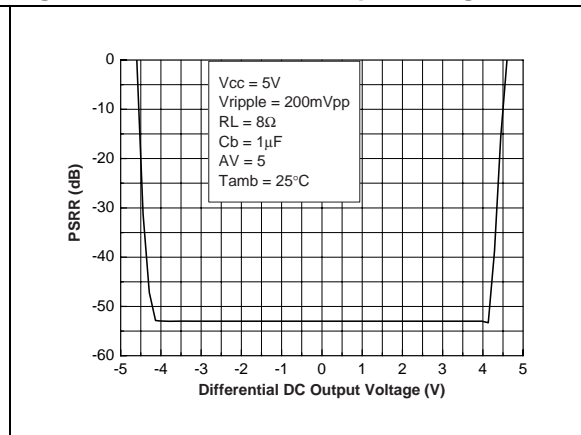

Figure 18. PSRR vs. DC output voltage

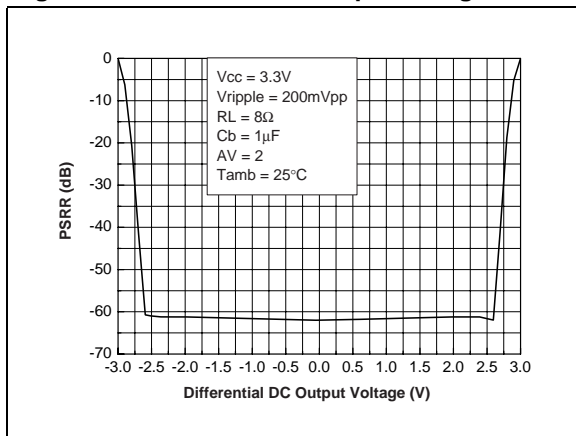

Figure 19. PSRR vs. DC output voltage

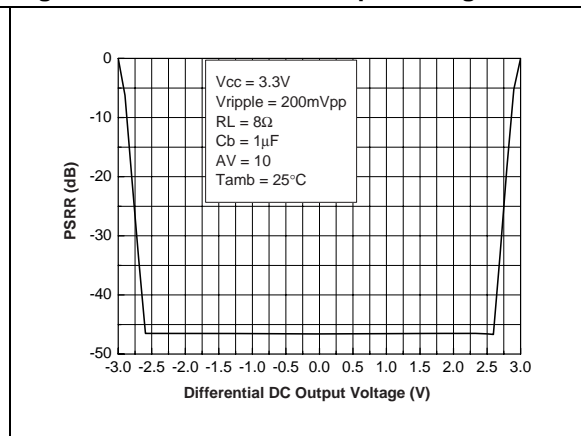

Figure 20. PSRR vs. DC output voltage

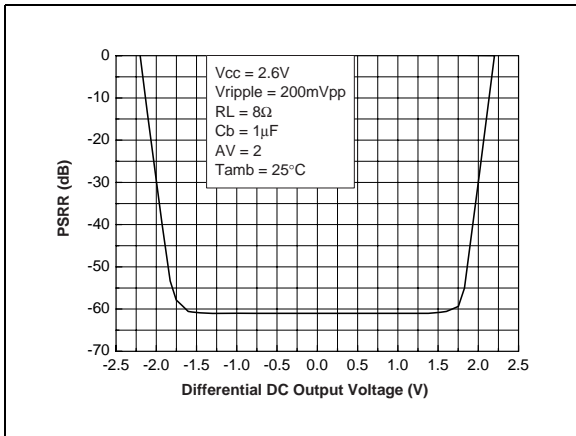

Figure 21. PSRR vs. DC output voltage

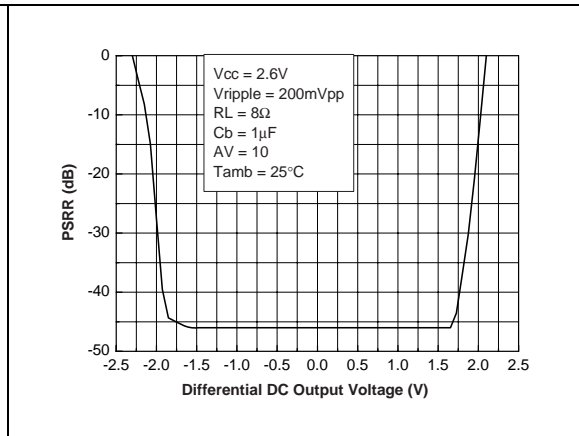

Figure 22. Output power vs. power supply voltage

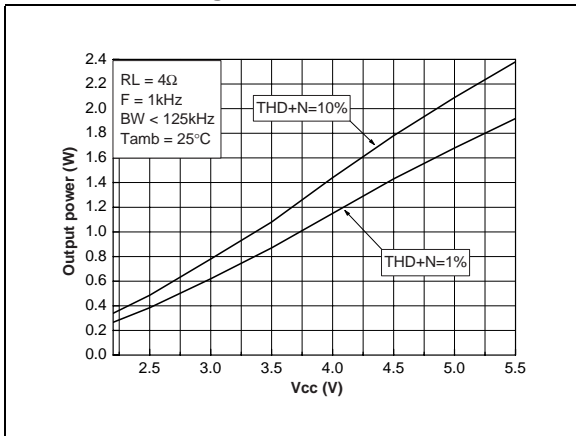

Figure 23. PSRR vs. DC output voltage

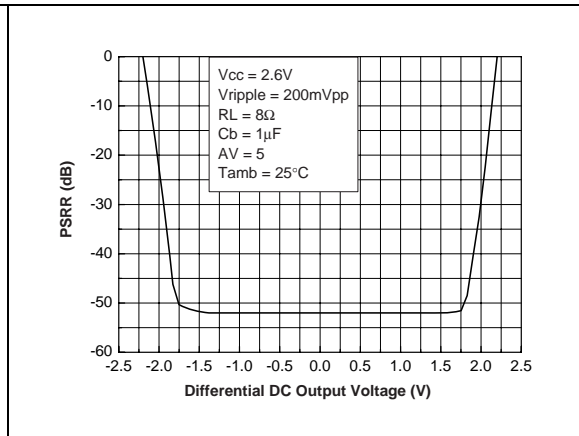

Figure 24. PSRR at F = 217 Hz vs. bypass capacitor

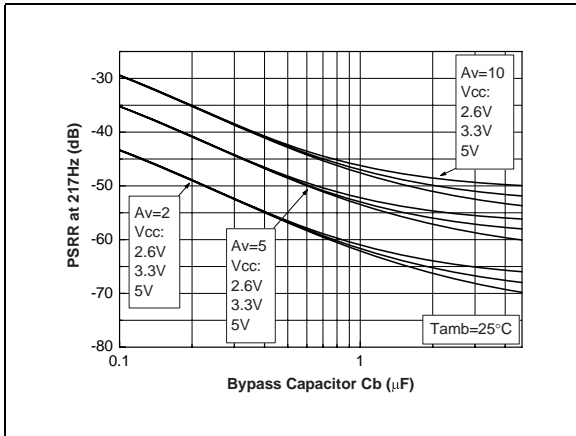

Figure 25. Output power vs. power supply voltage

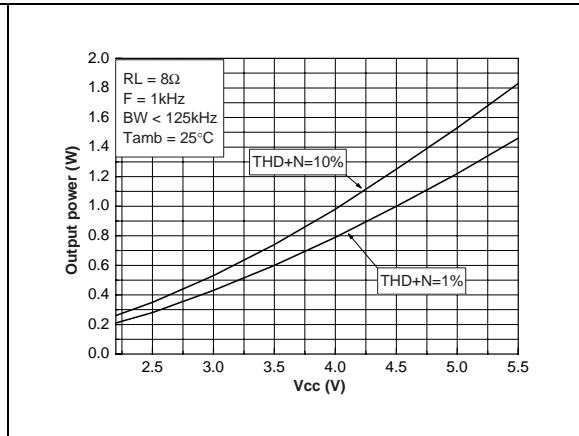

Figure 26. Output power vs. power supply voltage

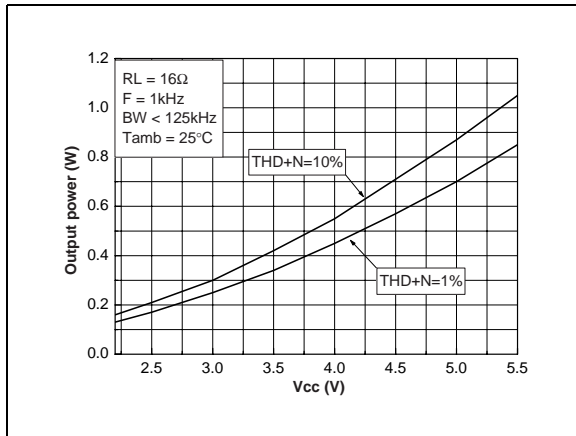

Figure 27. Output power vs. load resistor

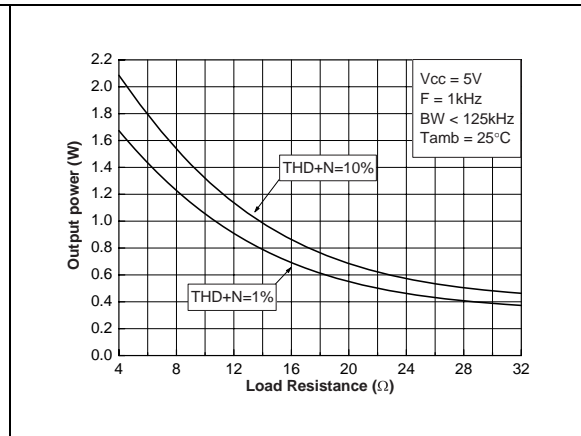

Figure 28. Output power vs. load resistor

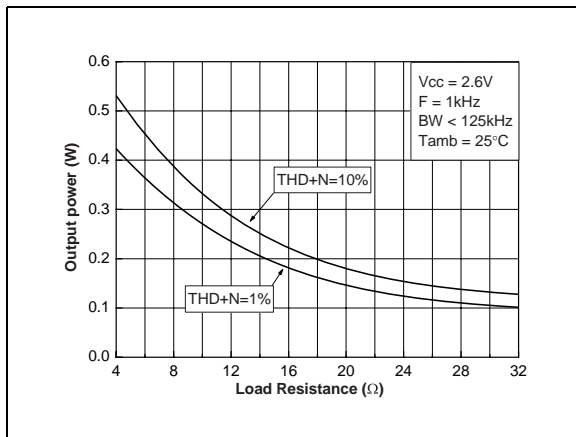

Figure 29. Output power vs. power supply voltage

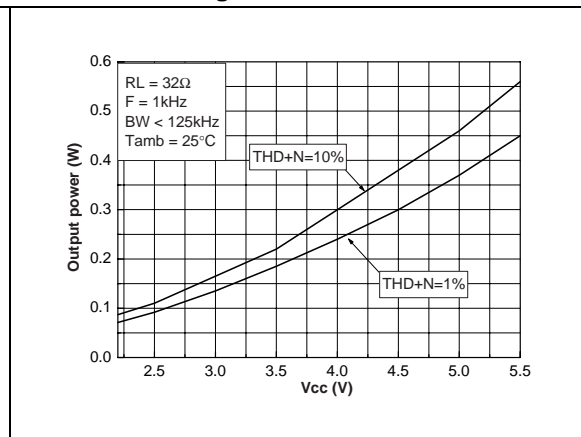

Figure 30. Output power vs. load resistor

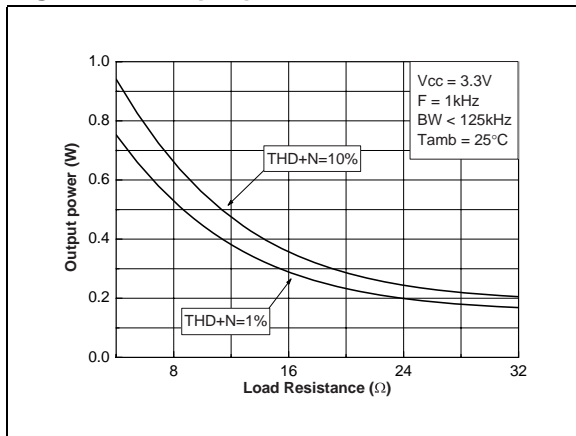

Figure 31. Power dissipation vs. P<sub>out</sub>

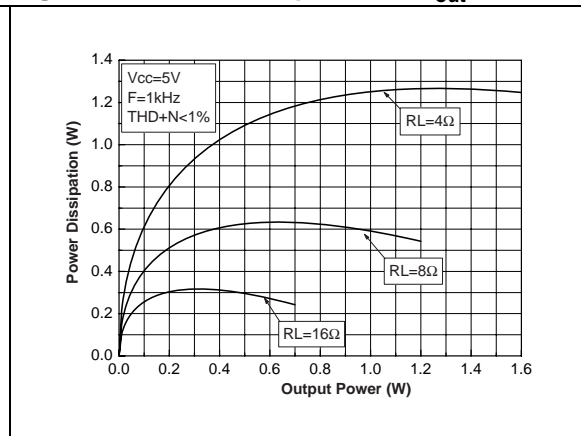

Figure 32. Power dissipation vs.  $P_{out}$

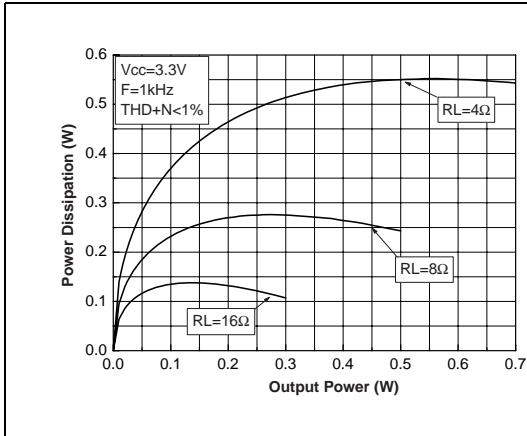

Figure 33. Power derating curves

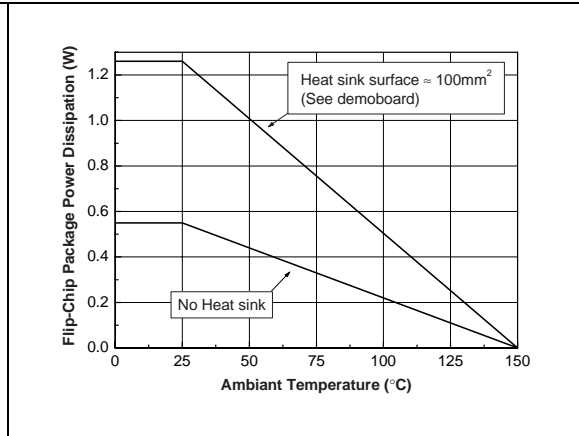

Figure 34. Clipping voltage vs. power supply voltage and load resistor

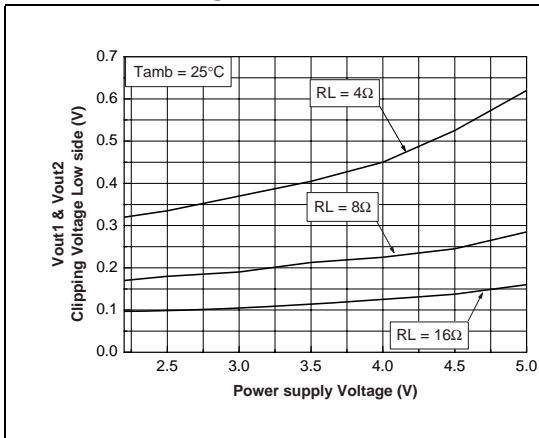

Figure 35. Power dissipation vs.  $P_{out}$

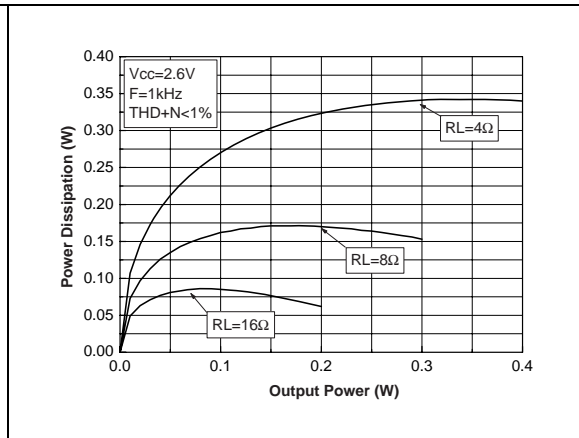

Figure 36. Clipping voltage vs. power supply voltage and load resistor

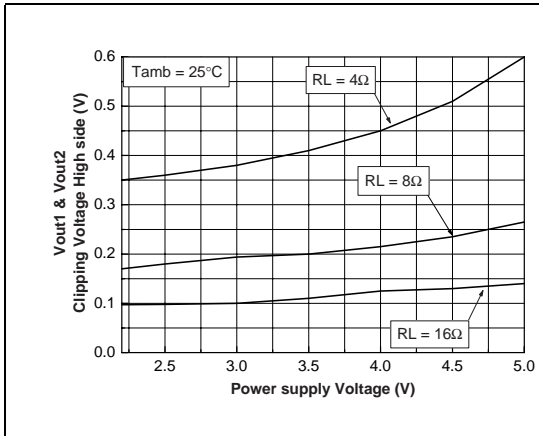

Figure 37. Current consumption vs. power supply voltage

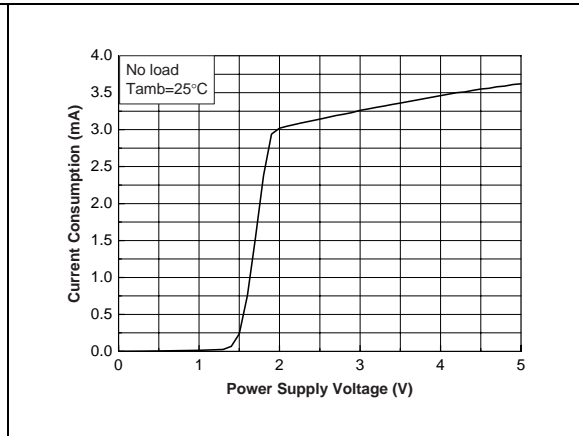

Figure 38. Current consumption vs. standby voltage @  $V_{CC} = 5V$

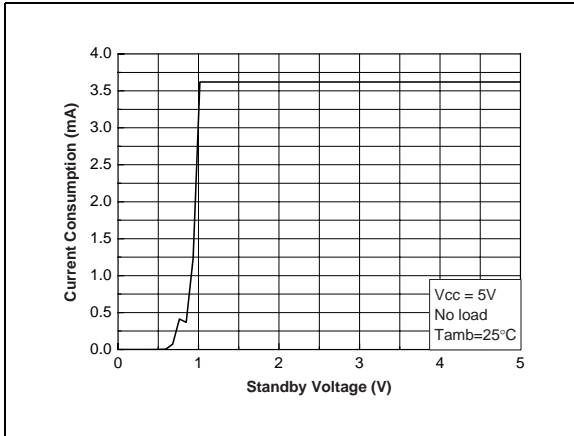

Figure 39. Current consumption vs. standby voltage @  $V_{CC} = 2.6V$

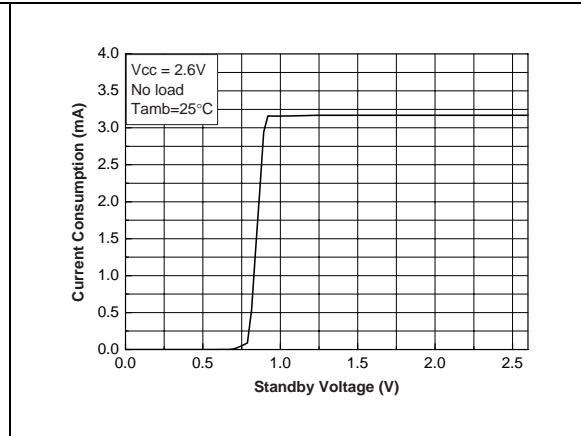

Figure 40. THD + N vs. output power

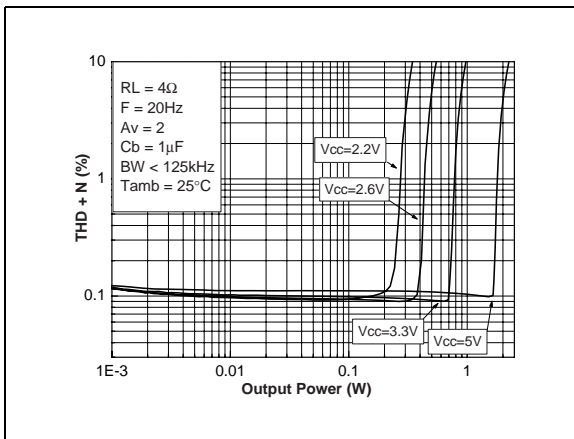

Figure 41. Current consumption vs. standby voltage @  $V_{CC} = 3.3V$

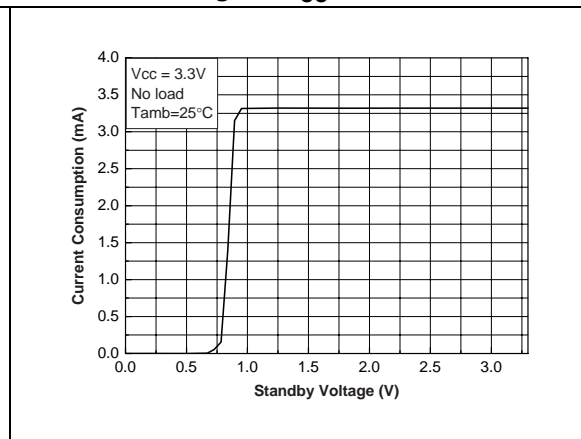

Figure 42. Current consumption vs. standby voltage @  $V_{CC} = 2.2V$

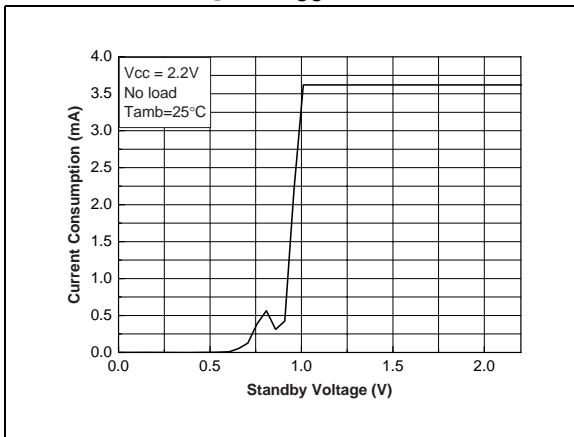

Figure 43. THD + N vs. output power

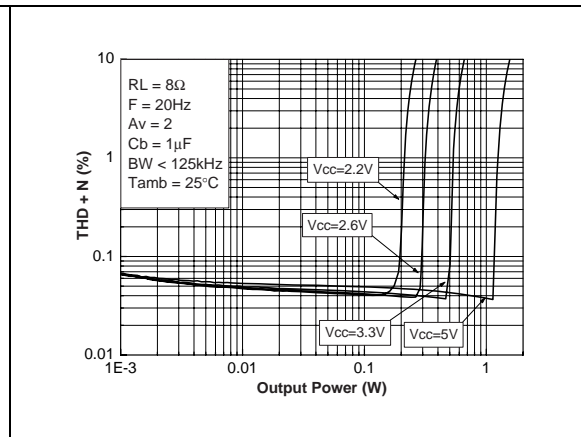

Figure 44. THD + N vs. output power

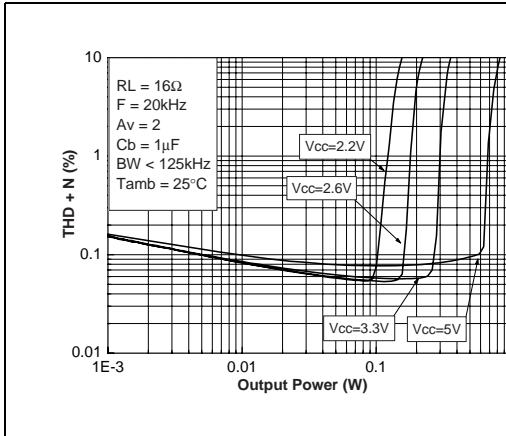

Figure 45. THD + N vs. output power

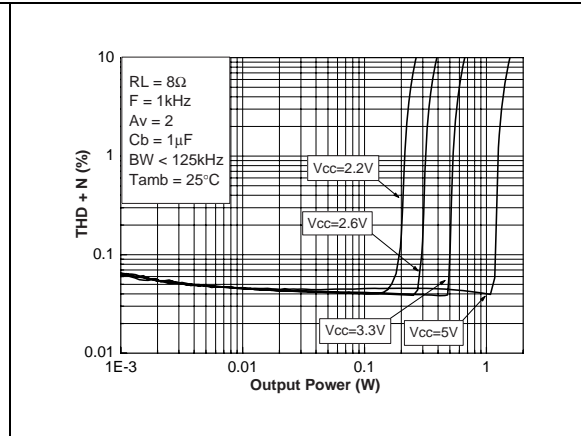

Figure 46. THD + N vs. output power

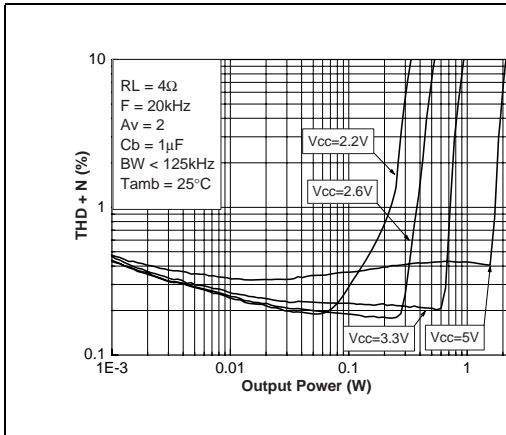

Figure 47. THD + N vs. output power

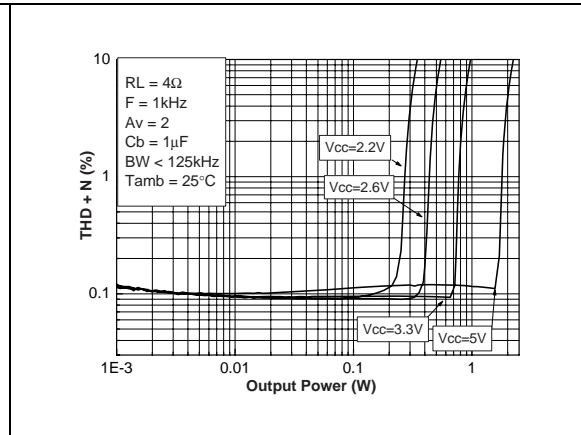

Figure 48. THD + N vs. output power

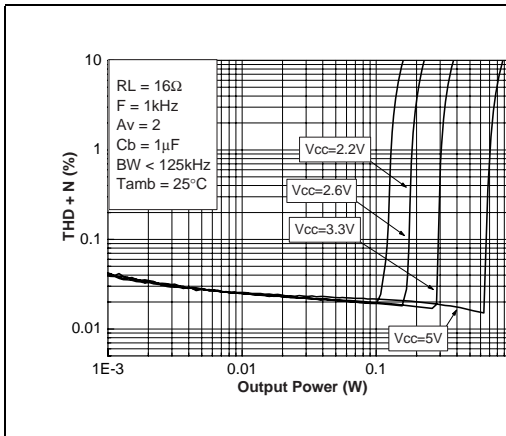

Figure 49. THD + N vs. output power

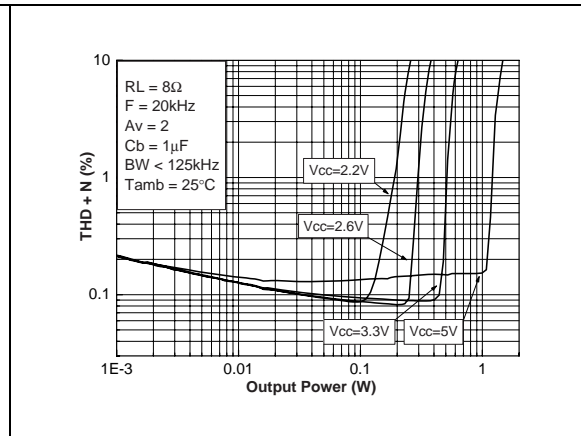

Figure 50. THD + N vs. output power

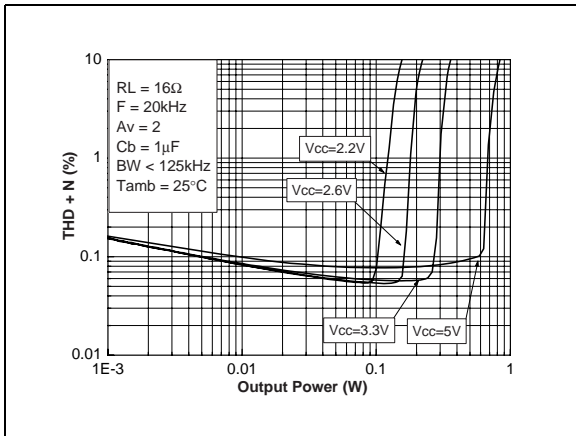

Figure 51. THD + N vs. frequency

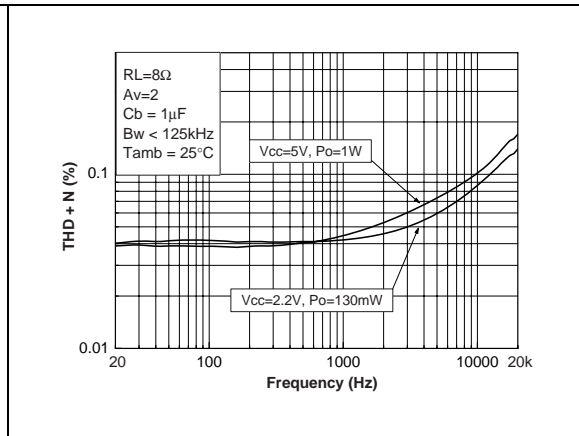

Figure 52. SNR vs. power supply with unweighted filter (20Hz to 20kHz)

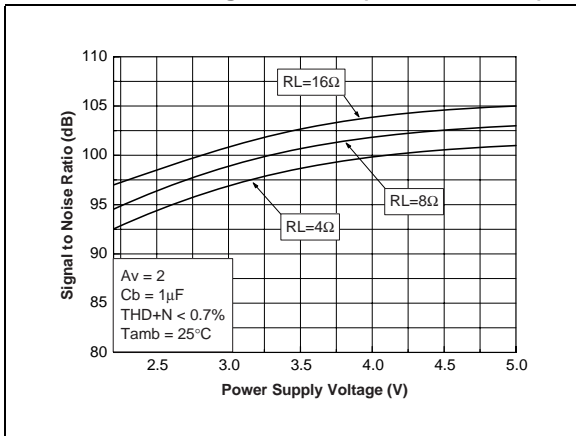

Figure 53. THD + N vs. frequency

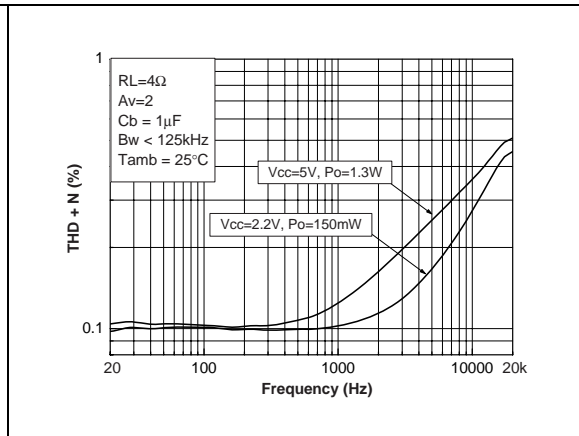

Figure 54. THD + N vs. frequency

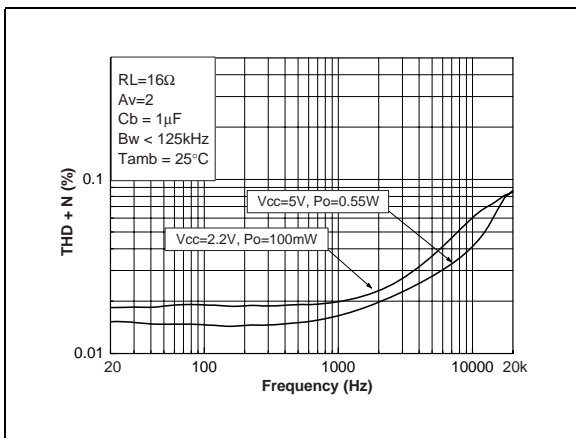

Figure 55. SNR vs. power supply with unweighted filter (20Hz to 20kHz)

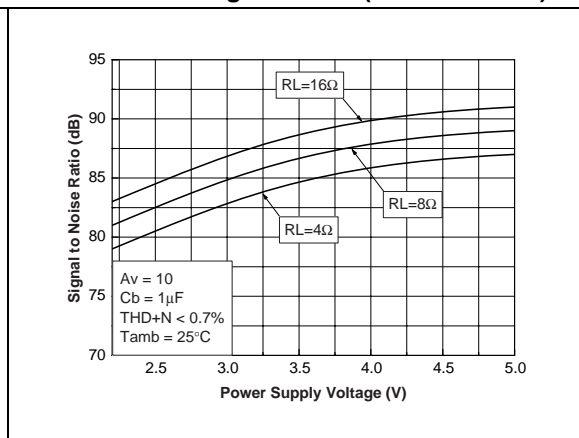



Figure 56. Signal to noise ratio vs. power supply with a weighted filter

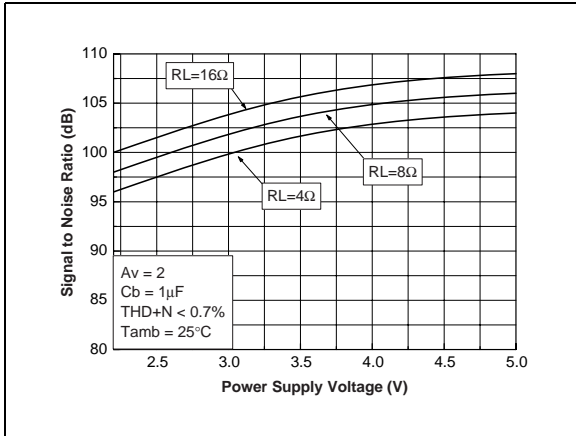

Figure 57. Output noise voltage device ON

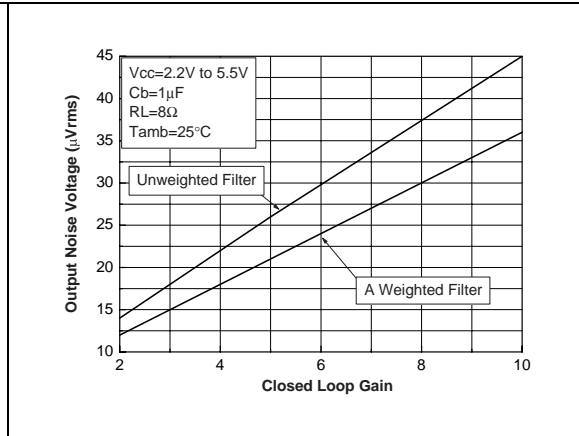

Figure 58. Signal to noise ratio vs. power supply with a weighted filter

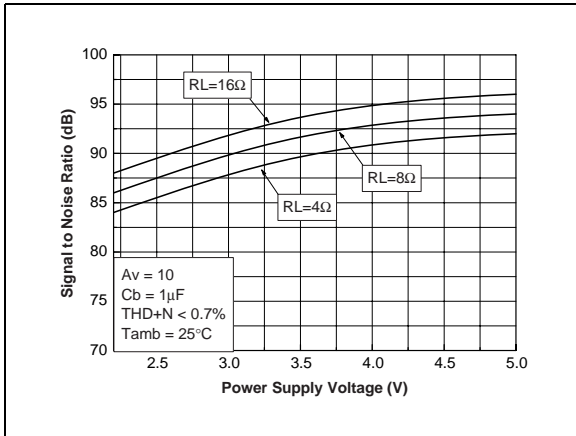
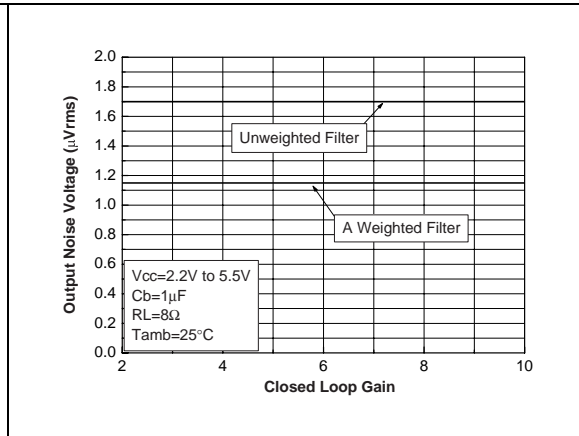

Figure 59. Output noise voltage device in Standby



## 4 Application information

### 4.1 BTL configuration principle

The TS4990 is a monolithic power amplifier with a BTL output type. BTL (bridge tied load) means that each end of the load is connected to two single-ended output amplifiers. Thus, we have:

$$\text{Single-ended output 1} = V_{\text{out1}} = V_{\text{out}} \text{ (V)}$$

$$\text{Single-ended output 2} = V_{\text{out2}} = -V_{\text{out}} \text{ (V)}$$

$$\text{and } V_{\text{out1}} - V_{\text{out2}} = 2V_{\text{out}} \text{ (V)}$$

The output power is:

$$P_{\text{out}} = \frac{(2V_{\text{outRMS}})^2}{R_L}$$

For the same power supply voltage, the output power in BTL configuration is four times higher than the output power in single-ended configuration.

### 4.2 Gain in a typical application

The typical application schematics are shown in [Figure 1 on page 4](#).

In the flat region (no  $C_{\text{in}}$  effect), the output voltage of the first stage is (in Volts):

$$V_{\text{out1}} = (-V_{\text{in}}) \frac{R_{\text{feed}}}{R_{\text{in}}}$$

For the second stage:  $V_{\text{out2}} = -V_{\text{out1}}$  (V)

The differential output voltage is (in Volts):

$$V_{\text{out2}} - V_{\text{out1}} = 2V_{\text{in}} \frac{R_{\text{feed}}}{R_{\text{in}}}$$

The differential gain named gain ( $G_v$ ) for more convenience is:

$$G_v = \frac{V_{\text{out2}} - V_{\text{out1}}}{V_{\text{in}}} = 2 \frac{R_{\text{feed}}}{R_{\text{in}}}$$

$V_{\text{out2}}$  is in phase with  $V_{\text{in}}$  and  $V_{\text{out1}}$  is phased  $180^\circ$  with  $V_{\text{in}}$ . This means that the positive terminal of the loudspeaker should be connected to  $V_{\text{out2}}$  and the negative to  $V_{\text{out1}}$ .

### 4.3 Low and high frequency response

In the low frequency region,  $C_{\text{in}}$  starts to have an effect.  $C_{\text{in}}$  forms with  $R_{\text{in}}$  a high-pass filter with a -3 dB cut-off frequency.  $F_{\text{CL}}$  is in Hz.

$$F_{\text{CL}} = \frac{1}{2\pi R_{\text{in}} C_{\text{in}}}$$

In the high frequency region, you can limit the bandwidth by adding a capacitor ( $C_{\text{feed}}$ ) in parallel with  $R_{\text{feed}}$ . It forms a low-pass filter with a -3 dB cut-off frequency.  $F_{\text{CH}}$  is in Hz.

$$F_{\text{CH}} = \frac{1}{2\pi R_{\text{feed}} C_{\text{feed}}}$$

The graph in [Figure 60](#) shows an example of  $C_{in}$  and  $C_{feed}$  influence.

**Figure 60. Frequency response gain vs.  $C_{in}$  and  $C_{feed}$**

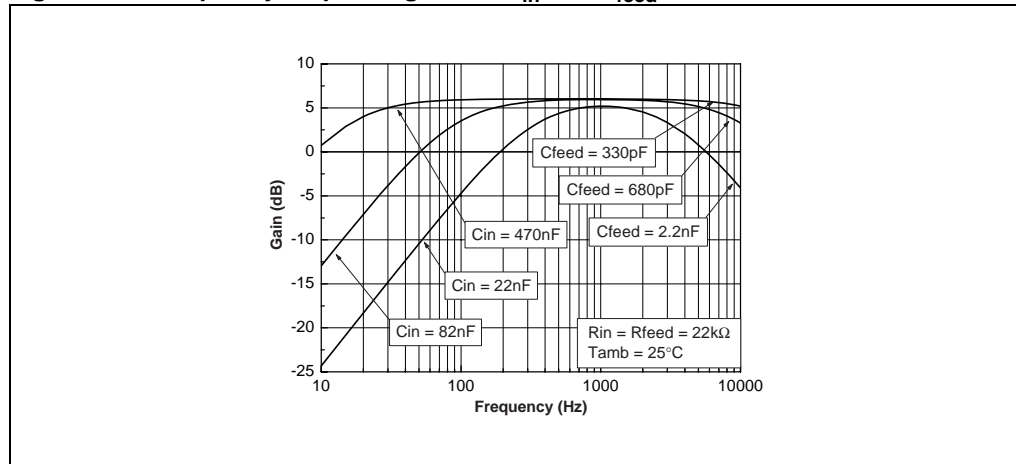

## 4.4 Power dissipation and efficiency

### Hypotheses:

- Load voltage and current are sinusoidal ( $V_{out}$  and  $I_{out}$ ).
- Supply voltage is a pure DC source ( $V_{CC}$ ).

The load can be expressed as:

$$V_{out} = V_{PEAK} \sin \omega t \quad (V)$$

and

$$I_{out} = \frac{V_{out}}{R_L} \quad (A)$$

and

$$P_{out} = \frac{V_{PEAK}^2}{2R_L} \quad (W)$$

Therefore, the average current delivered by the supply voltage is:

$$I_{CC_{AVG}} = 2 \frac{V_{PEAK}}{\pi R_L} \quad (A)$$

The power delivered by the supply voltage is:

$$P_{supply} = V_{CC} \cdot I_{CC_{AVG}} \quad (W)$$

Therefore, the **power dissipated by each amplifier** is:

$$P_{\text{diss}} = P_{\text{supply}} - P_{\text{out}} \text{ (W)}$$

$$P_{\text{diss}} = \frac{2\sqrt{2}V_{\text{CC}}}{\pi\sqrt{R_{\text{L}}}}\sqrt{P_{\text{out}}} - P_{\text{out}}$$

and the maximum value is obtained when:

$$\frac{\delta P_{\text{diss}}}{\delta P_{\text{out}}} = 0$$

and its value is:

$$P_{\text{diss}_{\text{max}}} = \frac{2V_{\text{CC}}^2}{\pi^2 R_{\text{L}}} \text{ (W)}$$

*Note:* This maximum value is only dependent on power supply voltage and load values.

The **efficiency** is the ratio between the output power and the power supply:

$$\eta = \frac{P_{\text{out}}}{P_{\text{supply}}} = \frac{\pi V_{\text{PEAK}}}{4V_{\text{CC}}}$$

The maximum theoretical value is reached when  $V_{\text{PEAK}} = V_{\text{CC}}$ , so:

$$\frac{\pi}{4} = 78.5\%$$

## 4.5 Decoupling of the circuit

Two capacitors are needed to correctly bypass the TS4990: a power supply bypass capacitor  $C_{\text{s}}$  and a bias voltage bypass capacitor  $C_{\text{b}}$ .

$C_{\text{s}}$  has particular influence on the THD+N in the high frequency region (above 7 kHz) and an indirect influence on power supply disturbances. With a value for  $C_{\text{s}}$  of 1  $\mu\text{F}$ , you can expect THD+N levels similar to those shown in the datasheet.

In the high frequency region, if  $C_{\text{s}}$  is lower than 1  $\mu\text{F}$ , it increases THD+N and disturbances on the power supply rail are less filtered.

On the other hand, if  $C_{\text{s}}$  is higher than 1  $\mu\text{F}$ , those disturbances on the power supply rail are more filtered.

$C_{\text{b}}$  has an influence on THD+N at lower frequencies, but its function is critical to the final result of PSRR (with input grounded and in the lower frequency region).

If  $C_{\text{b}}$  is lower than 1  $\mu\text{F}$ , THD+N increases at lower frequencies and PSRR worsens.

If  $C_{\text{b}}$  is higher than 1  $\mu\text{F}$ , the benefit on THD+N at lower frequencies is small, but the benefit to PSRR is substantial.

Note that  $C_{\text{in}}$  has a non-negligible effect on PSRR at lower frequencies. The lower the value of  $C_{\text{in}}$ , the higher the PSRR.

## 4.6 Wake-up time ( $t_{WU}$ )

When the standby is released to put the device ON, the bypass capacitor  $C_b$  is not charged immediately. Because  $C_b$  is directly linked to the bias of the amplifier, the bias will not work properly until the  $C_b$  voltage is correct. The time to reach this voltage is called wake-up time or  $t_{WU}$  and specified in the electrical characteristics tables with  $C_b = 1 \mu\text{F}$ .

If  $C_b$  has a value other than  $1 \mu\text{F}$ , refer to the graph in [Figure 61](#) to establish the wake-up time.

**Figure 61. Typical wake-up time vs.  $C_b$**

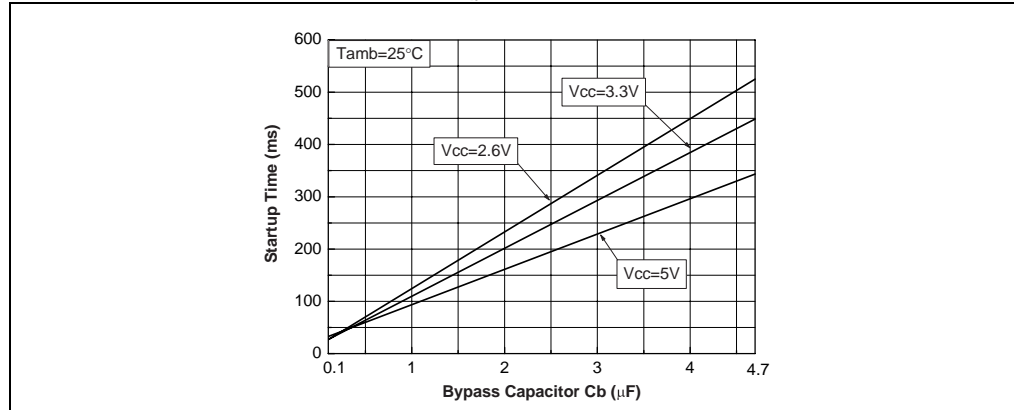

Due to process tolerances, the maximum value of wake-up time is shown in [Figure 62](#).

**Figure 62. Maximum wake-up time vs.  $C_b$**

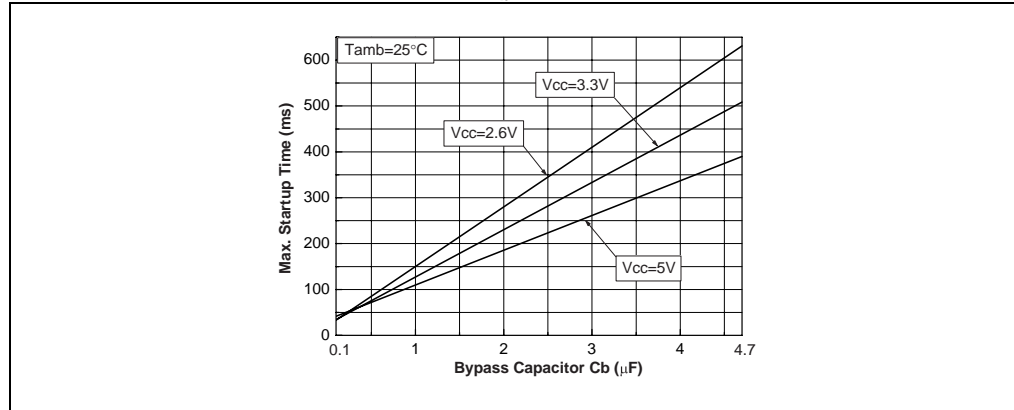

**Note:** The bypass capacitor  $C_b$  also has a typical tolerance of  $\pm 20\%$ . To calculate the wake-up time with this tolerance, refer to the graph above (considering for example for  $C_b = 1 \mu\text{F}$  in the range of  $0.8 \mu\text{F} \leq C_b \leq 1.2 \mu\text{F}$ ).

## 4.7 Standby time

When the standby command is set, the time required to put the two output stages in high impedance and the internal circuitry in standby mode is a few microseconds. In standby mode, the bypass pin and  $V_{in}$  pin are short-circuited to ground by internal switches. This allows a quick discharge of  $C_b$  and  $C_{in}$  capacitors.

## 4.8 Pop performance

Pop performance is intimately linked with the size of the input capacitor  $C_{in}$  and the bias voltage bypass capacitor  $C_b$ .

The size of  $C_{in}$  is dependent on the lower cut-off frequency and PSRR values requested. The size of  $C_b$  is dependent on THD+N and PSRR values requested at lower frequencies.

Moreover,  $C_b$  determines the speed with which the amplifier turns ON. In order to reach near zero pop and click, the equivalent input constant time,

$$\tau_{in} = (R_{in} + 2k\Omega) \times C_{in} \text{ (s) with } R_{in} \geq 5k\Omega$$

must not reach the  $\tau_{in}$  maximum value as indicated in [Figure 63](#) below.

**Figure 63.**  $\tau_{in}$  max. versus bypass capacitor

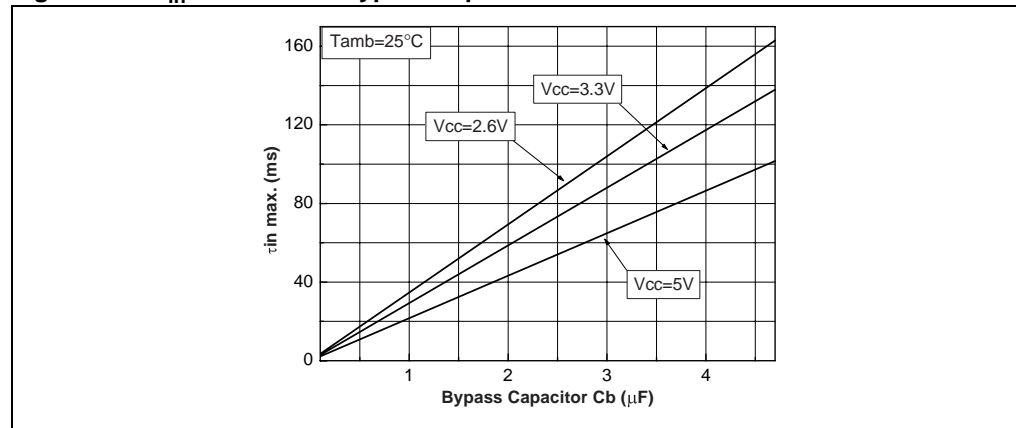

By following the previous rules, the TS4990 can reach near zero pop and click even with high gains such as 20 dB.

### Example:

With  $R_{in} = 22 \text{ k}\Omega$  and a 20 Hz, -3 dB low cut-off frequency,  $C_{in} = 361 \text{ nF}$ . So,  $C_{in} = 390 \text{ nF}$  with standard value which gives a lower cut-off frequency equal to 18.5 Hz. In this case,  $(R_{in} + 2k\Omega) \times C_{in} = 9.36 \text{ ms}$ . By referring to the previous graph, if  $C_b = 1 \mu\text{F}$  and  $V_{CC} = 5 \text{ V}$ , we read 20 ms max. This value is twice as high as our current value, thus we can state that pop and click will be reduced to its lowest value.

Minimizing both  $C_{in}$  and the gain benefits both the pop phenomenon, and the cost and size of the application.

## 4.9 Application example: differential input, BTL power amplifier

The schematics in [Figure 64](#) show how to configure the TS4990 to work in differential input mode. The gain of the amplifier is:

$$G_{VDIFF} = 2 \frac{R_2}{R_1}$$

In order to reach the best performance of the differential function,  $R_1$  and  $R_2$  should be matched at 1% max.

**Figure 64. Differential input amplifier configuration**

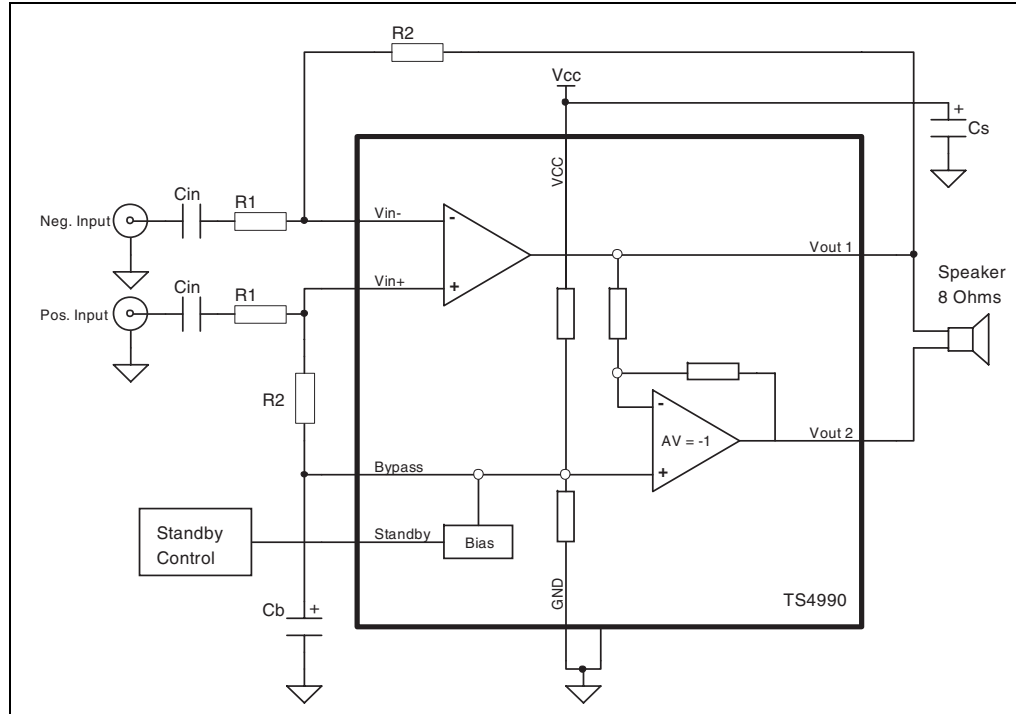

The input capacitor  $C_{in}$  can be calculated by the following formula using the -3 dB lower frequency required. ( $F_L$  is the lower frequency required).

$$C_{in} \approx \frac{1}{2\pi R_1 F_L} \quad (F)$$

Note: This formula is true only if:

$$F_{CB} = \frac{1}{2\pi(R_1 + R_2)C_B} \quad (Hz)$$

is 5 times lower than  $F_L$ .

**Example bill of materials**

The bill of materials in [Table 7](#) is for the example of a differential amplifier with a gain of 2 and a -3 dB lower cut-off frequency of about 80 Hz.

**Table 7. Bill of materials for differential input amplifier application**

Pin name	Functional description
R <sub>1</sub>	20k / 1%
R <sub>2</sub>	20k / 1%
C <sub>in</sub>	100nF
C <sub>b</sub> =C <sub>s</sub>	1μF
U1	TS4990

## 5 Package information

In order to meet environmental requirements, STMicroelectronics offers these devices in ECOPACK® packages. These packages have a lead-free second level interconnect. The category of second level interconnect is marked on the package and on the inner box label, in compliance with JEDEC Standard JESD97. The maximum ratings related to soldering conditions are also marked on the inner box label. ECOPACK is an STMicroelectronics trademark. ECOPACK specifications are available at: [www.st.com](http://www.st.com).

### 5.1 Flip-chip package information

Figure 65. Flip chip pinout (top view)

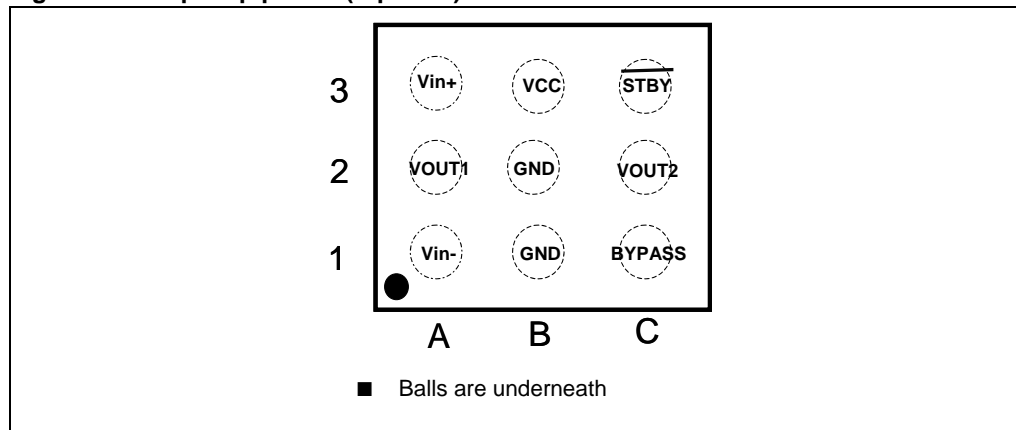

Figure 66. Marking (top view)

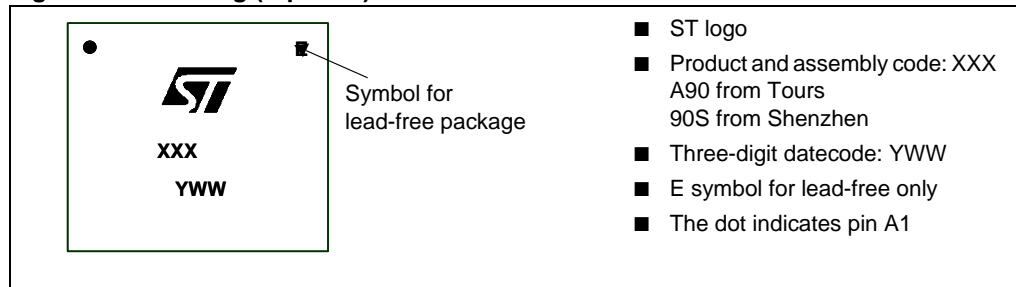



Figure 67. Package mechanical data for 9-bump flip-chip package

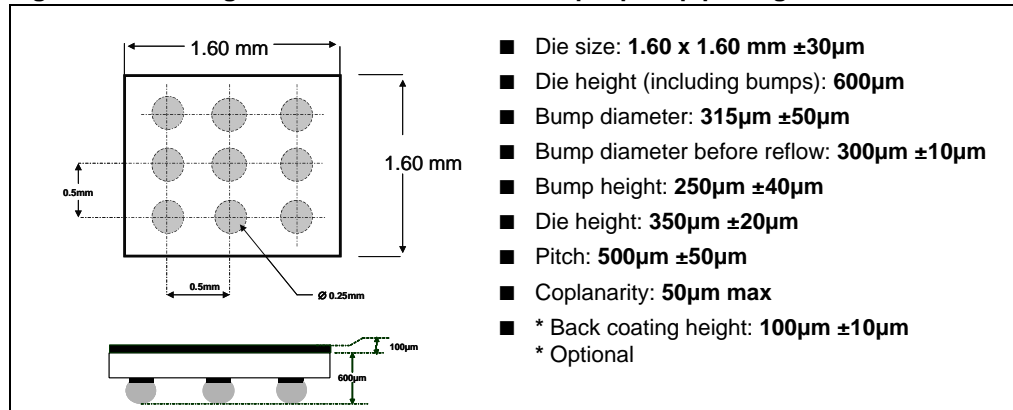
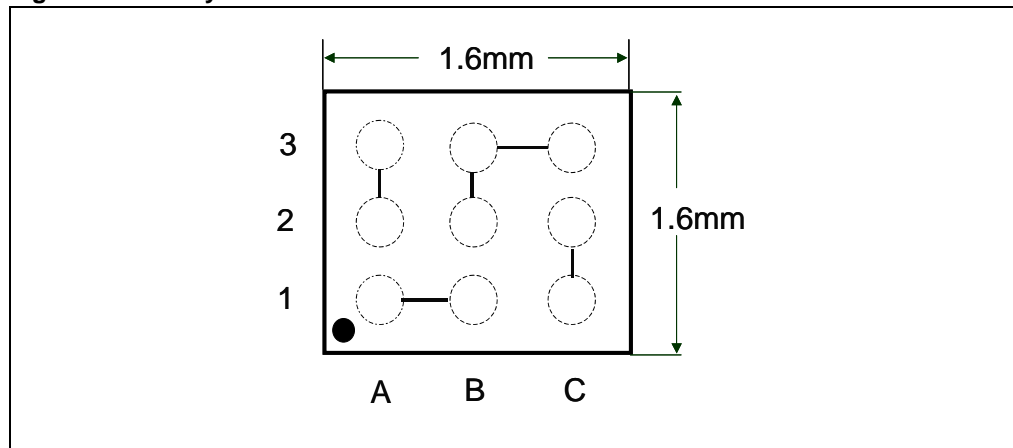

Figure 68. Daisy chain mechanical data



The daisy chain sample features two-by-two pin connections. The schematics in [Figure 68](#) illustrate the way pins connect to each other. This sample is used to test continuity on your board. Your PCB needs to be designed the opposite way, so that pins that are unconnected in the daisy chain sample, are connected on your PCB. If you do this, by simply connecting an Ohmmeter between pin A1 and pin A3, the soldering process continuity can be tested.

Figure 69. TS4990 footprint recommendations

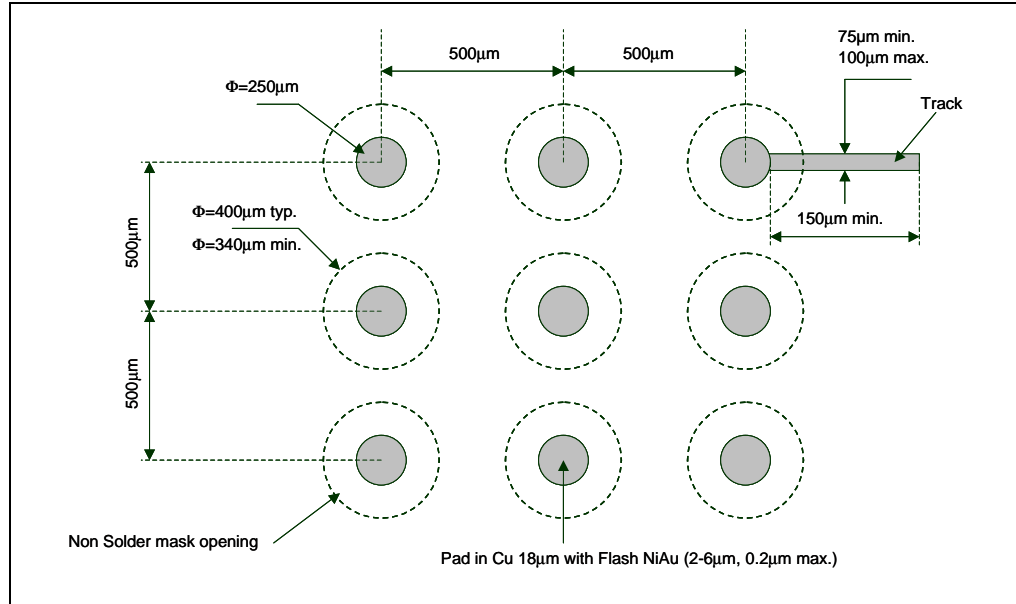
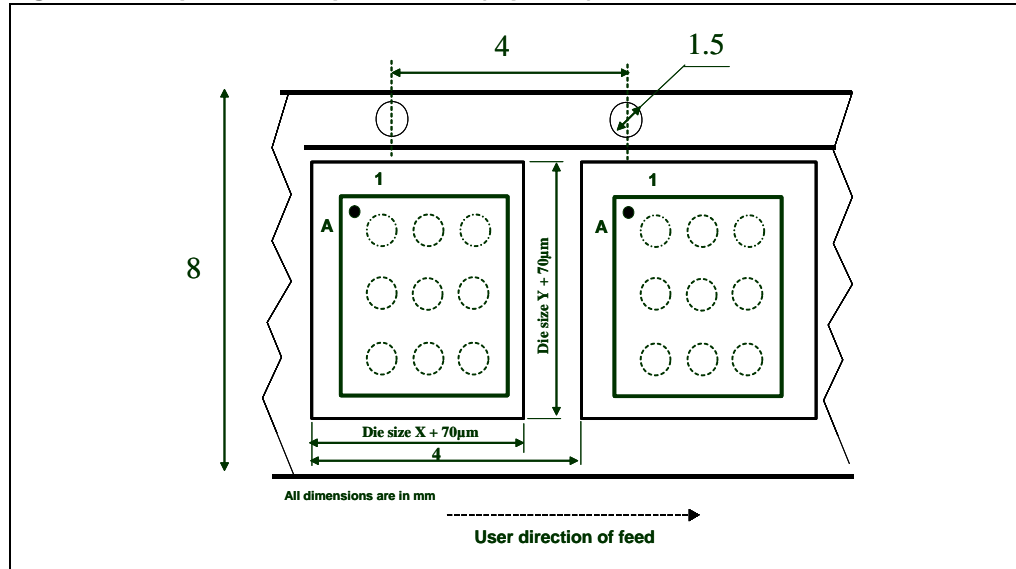

Figure 70. Tape and reel specification (top view)



**Device orientation**

The devices are oriented in the carrier pocket with pin number A1 adjacent to the sprocket holes.

## 5.2 MiniSO-8 package information

Figure 71. MiniSO-8 package mechanical drawing

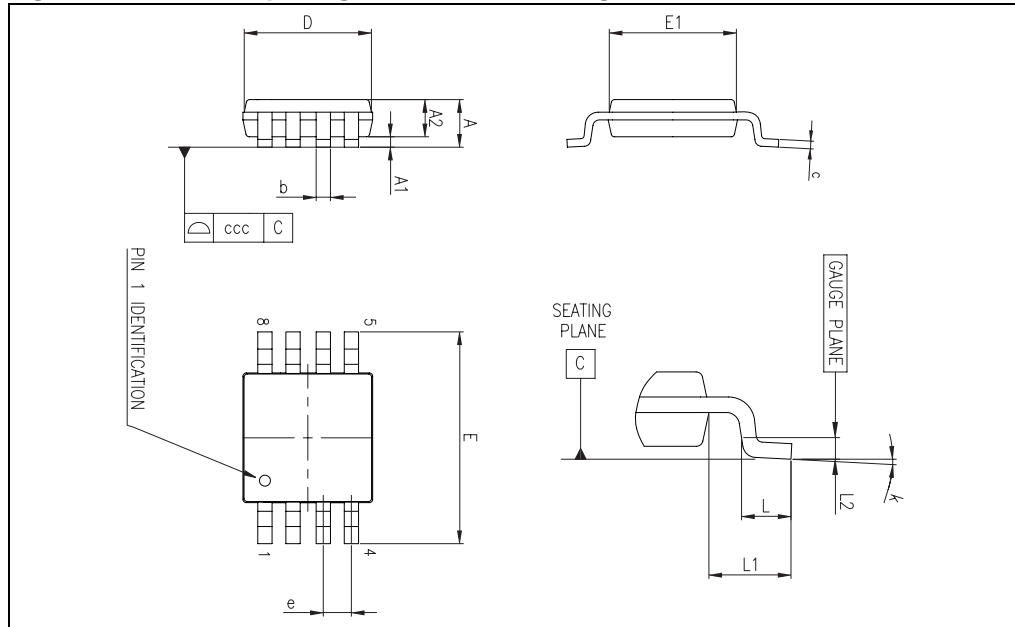

Table 8. MiniSO-8 package mechanical data

Ref.	Dimensions					
	Millimeters			Inches		
	Min.	Typ.	Max.	Min.	Typ.	Max.
A			1.1			0.043
A1	0		0.15	0		0.006
A2	0.75	0.85	0.95	0.030	0.033	0.037
b	0.22		0.40	0.009		0.016
c	0.08		0.23	0.003		0.009
D	2.80	3.00	3.20	0.11	0.118	0.126
E	4.65	4.90	5.15	0.183	0.193	0.203
E1	2.80	3.00	3.10	0.11	0.118	0.122
e		0.65			0.026	
L	0.40	0.60	0.80	0.016	0.024	0.031
L1		0.95			0.037	
L2		0.25			0.010	
k	0°		8°	0°		8°
ccc			0.10			0.004



### 5.4 SO-8 package information

Figure 73. SO-8 package mechanical drawing

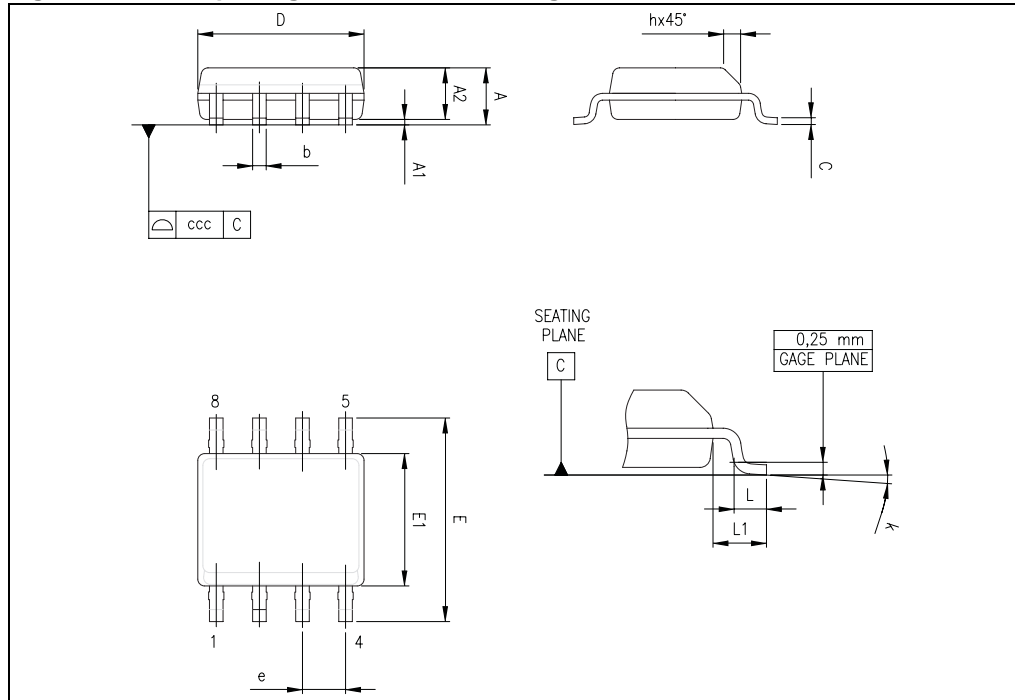

Table 10. SO-8 package mechanical data

Ref.	Dimensions					
	Millimeters			Inches		
	Min.	Typ.	Max.	Min.	Typ.	Max.
A			1.75			0.069
A1	0.10		0.25	0.004		0.010
A2	1.25			0.049		
b	0.28		0.48	0.011		0.019
c	0.17		0.23	0.007		0.010
D	4.80	4.90	5.00	0.189	0.193	0.197
H	5.80	6.00	6.20	0.228	0.236	0.244
E1	3.80	3.90	4.00	0.150	0.154	0.157
e		1.27			0.050	
h	0.25		0.50	0.010		0.020
L	0.40		1.27	0.016		0.050
k	1°		8°	1°		8°
ccc			0.10			0.004

## 6 Ordering information

Table 11. Order codes

Order code	Temperature range	Package	Packing	Marking
TS4990IJT TS4990EIJT <sup>(1)</sup>	-40°C, +85°C	Flip chip, 9 bumps	Tape & reel	90
TSDC05IJT TSDC05EIJT <sup>(2)</sup>		Flip chip, 9 bumps	Tape & reel	DC3
TS4990IST		MiniSO-8	Tape & reel	K990
TS4990IQT		DFN8	Tape & reel	K990
TS4990EKIJT		FC + back coating	Tape & reel	90
TS4990ID TS4990IDT		SO-8	Tube or Tape & reel	TS4990I

1. Lead-free Flip chip part number.
2. Lead free daisy chain part number.

## 7 Revision history

**Table 12. Document revision history**

Date	Revision	Changes
1-Jul-2002	1	First release.
4-Sep-2003	2	Update mechanical data.
1-Oct-2004	3	Order code for back coating on flip-chip.
2-Apr-2005	4	Typography error on page 1: Mini-SO-8 pin connection.
May-2005	5	New marking for assembly code plant.
1-Jul-2005	6	Error on <a href="#">Table 4 on page 5</a> . Parameters in wrong column.
28-Sep-2005	7	Updated mechanical coplanarity data to 50µm (instead of 60µm) (see <a href="#">Figure 67 on page 25</a> ).
14-Mar-2006	8	SO-8 package inserted in the datasheet.
21-Jul-2006	9	Update of <a href="#">Figure 66 on page 24</a> . Disclaimer update.
11-May-2007	10	Corrected value of PSRR in <a href="#">Table 5 on page 6</a> from 1 to 61 (typical value). Moved <a href="#">Table 3: Component descriptions</a> to <a href="#">Section 2: Typical application schematics on page 4</a> . Merged daisy chain flip-chip order code table into <a href="#">Table 11: Order codes on page 30</a> .
17-Jan-2008	11	Corrected pitch error in DFN8 package information. Actual pitch is 0.5mm. Updated DFN8 package dimensions to correspond to JEDEC databook definition (in previous versions of datasheet, package dimensions were as in manufacturer's drawing). Corrected error in MiniSO-8 package information (L and L1 values were inverted). Reformatted package information.
21-May-2008	12	Corrected value of output resistance vs. ground in standby mode: removed from <a href="#">Table 2</a> , and added in <a href="#">Table 4</a> , <a href="#">Table 5</a> , and <a href="#">Table 6</a> .

**Please Read Carefully:**

Information in this document is provided solely in connection with ST products. STMicroelectronics NV and its subsidiaries ("ST") reserve the right to make changes, corrections, modifications or improvements, to this document, and the products and services described herein at any time, without notice.

All ST products are sold pursuant to ST's terms and conditions of sale.

Purchasers are solely responsible for the choice, selection and use of the ST products and services described herein, and ST assumes no liability whatsoever relating to the choice, selection or use of the ST products and services described herein.

No license, express or implied, by estoppel or otherwise, to any intellectual property rights is granted under this document. If any part of this document refers to any third party products or services it shall not be deemed a license grant by ST for the use of such third party products or services, or any intellectual property contained therein or considered as a warranty covering the use in any manner whatsoever of such third party products or services or any intellectual property contained therein.

**UNLESS OTHERWISE SET FORTH IN ST'S TERMS AND CONDITIONS OF SALE ST DISCLAIMS ANY EXPRESS OR IMPLIED WARRANTY WITH RESPECT TO THE USE AND/OR SALE OF ST PRODUCTS INCLUDING WITHOUT LIMITATION IMPLIED WARRANTIES OF MERCHANTABILITY, FITNESS FOR A PARTICULAR PURPOSE (AND THEIR EQUIVALENTS UNDER THE LAWS OF ANY JURISDICTION), OR INFRINGEMENT OF ANY PATENT, COPYRIGHT OR OTHER INTELLECTUAL PROPERTY RIGHT.**

**UNLESS EXPRESSLY APPROVED IN WRITING BY AN AUTHORIZED ST REPRESENTATIVE, ST PRODUCTS ARE NOT RECOMMENDED, AUTHORIZED OR WARRANTED FOR USE IN MILITARY, AIR CRAFT, SPACE, LIFE SAVING, OR LIFE SUSTAINING APPLICATIONS, NOR IN PRODUCTS OR SYSTEMS WHERE FAILURE OR MALFUNCTION MAY RESULT IN PERSONAL INJURY, DEATH, OR SEVERE PROPERTY OR ENVIRONMENTAL DAMAGE. ST PRODUCTS WHICH ARE NOT SPECIFIED AS "AUTOMOTIVE GRADE" MAY ONLY BE USED IN AUTOMOTIVE APPLICATIONS AT USER'S OWN RISK.**

Resale of ST products with provisions different from the statements and/or technical features set forth in this document shall immediately void any warranty granted by ST for the ST product or service described herein and shall not create or extend in any manner whatsoever, any liability of ST.

ST and the ST logo are trademarks or registered trademarks of ST in various countries.

Information in this document supersedes and replaces all information previously supplied.

The ST logo is a registered trademark of STMicroelectronics. All other names are the property of their respective owners.

© 2008 STMicroelectronics - All rights reserved

STMicroelectronics group of companies

Australia - Belgium - Brazil - Canada - China - Czech Republic - Finland - France - Germany - Hong Kong - India - Israel - Italy - Japan - Malaysia - Malta - Morocco - Singapore - Spain - Sweden - Switzerland - United Kingdom - United States of America

[www.st.com](http://www.st.com)