

# LM4879 Boomer® Audio Power Amplifier Series

## 1.1 Watt Audio Power Amplifier

### General Description

The LM4879 is an audio power amplifier primarily designed for demanding applications in mobile phones and other portable communication device applications. It is capable of delivering 1.1 watt of continuous average power to an 8Ω BTL load with less than 1% distortion (THD+N) from a 5V<sub>DC</sub> power supply.

Boomer audio power amplifiers were designed specifically to provide high quality output power with a minimal amount of external components. The LM4879 does not require output coupling capacitors or bootstrap capacitors, and therefore is ideally suited for lower-power portable applications where minimal space and power consumption are primary requirements.

The LM4879 features a low-power consumption global shutdown mode, which is achieved by driving the shutdown pin with logic low. Additionally, the LM4879 features an internal thermal shutdown protection mechanism.

The LM4879 contains advanced pop & click circuitry which eliminates noises which would otherwise occur during turn-on and turn-off transitions.

The LM4879 is unity-gain stable and can be configured by external gain-setting resistors.

### Key Specifications

|                                 |             |
|---------------------------------|-------------|
| ■ PSRR: 5V, 3V @ 217Hz          | 62dB (typ)  |
| ■ Power Output at 5V & 1% THD+N | 1.1W (typ)  |
| ■ Power Output at 3V & 1% THD+N | 350mW (typ) |
| ■ Shutdown Current              | 0.1μA (typ) |

### Features

- No output coupling capacitors, snubber networks or bootstrap capacitors required
- Unity gain stable
- Ultra low current shutdown mode
- Fast turn on: 80ms (typ), 110ms (max) with 1.0μF capacitor
- BTL output can drive capacitive loads up to 100pF
- Advanced pop & click circuitry eliminates noises during turn-on and turn-off transitions
- 2.2V - 5.0V operation
- Available in space-saving μSMD, LLP, and MSOP packages

### Applications

- Mobile Phones
- PDAs
- Portable electronic devices

### Typical Application

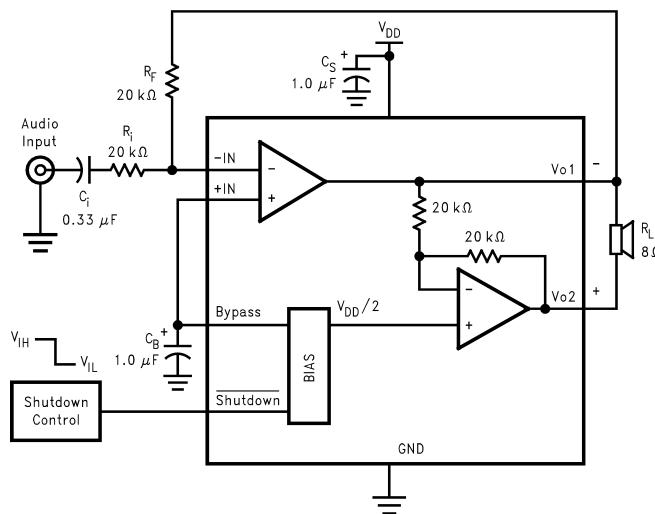
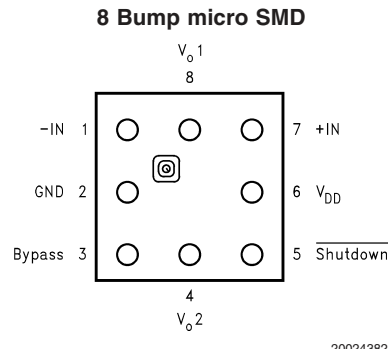

FIGURE 1. Typical Audio Amplifier Application Circuit

Boomer® is a registered trademark of National Semiconductor Corporation.

# Connection Diagrams



**Top View**  
 Order Number LM4879IBP, LM4879IBPX  
 See NS Package Number BPA08DDB

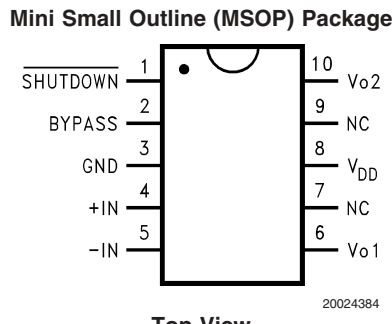

**Top View**  
 NC = No Connect  
 Order Number LM4879MM  
 See NS Package Number MUB10A

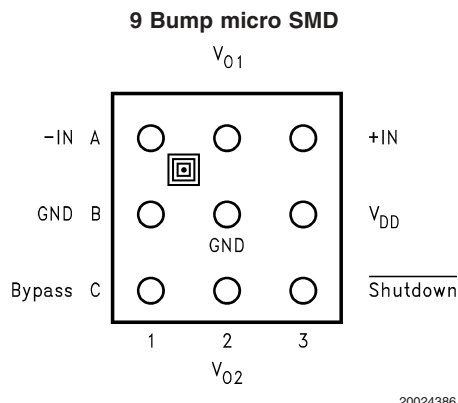

**Top View**  
 Order Number LM4879IBL, LM4879IBLX  
 See NS package Number BLA09AAB

**8 Bump micro SMD Marking**

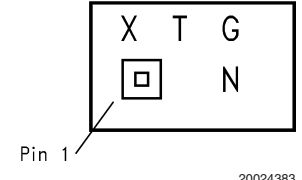

**Top View**  
 X - Date Code  
 T - Die Traceability  
 G - Boomer Family  
 N- LM4879IBP

**MSOP Marking**

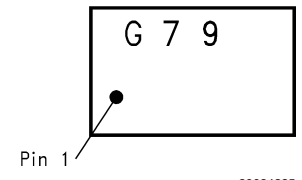

**Top View**  
 G - Boomer Family  
 79-LM4879MM

**9 Bump micro SMD Marking**

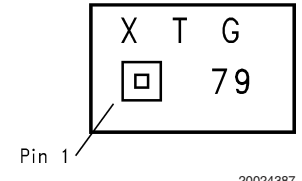

**Top View**  
 X - Date Code  
 T - Die Traceability  
 G - Boomer Family  
 79 - LM4879IBL

# Connection Diagrams (Continued)

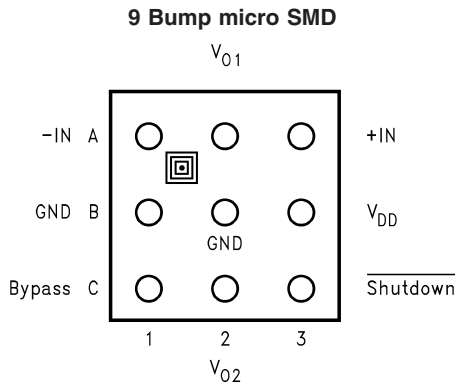

**Top View**  
**Order Number LM4879ITL, LM4879ITLX**  
**See NS package Number TLA09AAA**

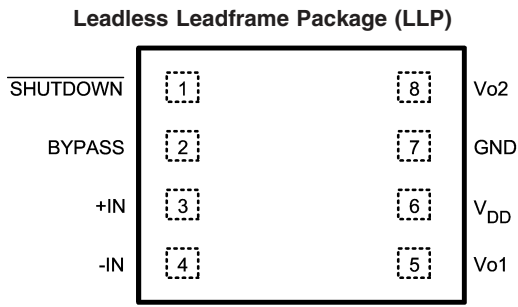

**Top View**  
**Order Number LM4879SD**  
**See NS Package Number SDC08A**

**9 Bump micro SMD Marking**

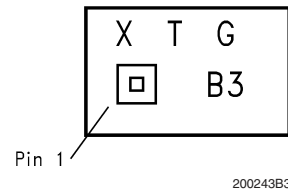

**Top View**  
**X - Date Code**  
**T - Die Traceability**  
**G - Boomer Family**  
**B3 - LM4879ITL**

**LLP Marking**

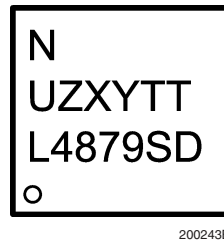

**Top View**  
**N - NS Logo**  
**U - Fab Code**  
**Z - Assembly Plant Code**  
**XY - Date Code**  
**TT - Die Traceability**  
**L4879SD - LM4879SD**

**Absolute Maximum Ratings** (Note 2)

If Military/Aerospace specified devices are required, please contact the National Semiconductor Sales Office/Distributors for availability and specifications.

|                             |                          |
|-----------------------------|--------------------------|
| Supply Voltage (Note 9)     | 6.0V                     |
| Storage Temperature         | -65°C to +150°C          |
| Input Voltage               | -0.3V to $V_{DD} + 0.3V$ |
| Power Dissipation (Note 3)  | Internally Limited       |
| ESD Susceptibility (Note 4) | 2000V                    |
| ESD Susceptibility (Note 5) | 200V                     |
| Junction Temperature        | 150°C                    |
| Thermal Resistance          |                          |

|                          |                   |
|--------------------------|-------------------|
| $\theta_{JA}$ (BPA08DDB) | 220°C/W (Note 10) |
| $\theta_{JA}$ (SDC08A)   | 64°C/W (Note 12)  |
| $\theta_{JA}$ (TLA09AAA) | 180°C/W (Note 10) |
| $\theta_{JA}$ (BLA09AAB) | 180°C/W (Note 10) |
| $\theta_{JC}$ (MUB10A)   | 56°C/W            |
| $\theta_{JA}$ (MUB10A)   | 190°C/W           |

**Operating Ratings**

Temperature Range

$T_{MIN} \leq T_A \leq T_{MAX}$

Supply Voltage

$-40^\circ\text{C} \leq T_A \leq 85^\circ\text{C}$

$2.2V \leq V_{DD} \leq 5.5V$

**Electrical Characteristics  $V_{DD} = 5V$**  (Notes 1, 2)

The following specifications apply for the circuit shown in Figure 1 unless otherwise specified. Limits apply for  $T_A = 25^\circ\text{C}$ .

| Symbol     | Parameter                       | Conditions   | LM4879                          |              | Units (Limits)      |
|------------|---------------------------------|--|---------------------------------|--------------|---------------------|
|            |                                 |  | Typical                         | Limit        |                     |
|            |                                 |  | (Note 6)                        | (Notes 7, 8) |                     |
| $I_{DD}$   | Quiescent Power Supply Current  | $V_{IN} = 0V, 8\Omega$ BTL   | 5                               | 10           | mA (max)            |
| $I_{SD}$   | Shutdown Current                | $V_{shutdown} = GND$   | 0.1                             | 2.0          | $\mu\text{A}$ (max) |
| $V_{OS}$   | Output Offset Voltage           |  | 5                               | 40           | mV (max)            |
| $P_o$      | Output Power                    | THD+N = 1% (max); f = 1kHz   | 1.1                             | 0.9          | W (min)             |
| THD+N      | Total Harmonic Distortion+Noise | $P_o = 0.4W_{rms}$ ; f = 1kHz  | 0.1                             |              | %                   |
| PSRR       | Power Supply Rejection Ratio    | $V_{ripple} = 200mV_{sine}$ p-p, $C_B = 1.0\mu\text{F}$<br>Input terminated with 10 $\Omega$ to ground | 68 (f = 1kHz)<br>62 (f = 217Hz) | 55           | dB (min)            |
| $V_{SDIH}$ | Shutdown High Input Voltage     |  |                                 | 1.4          | V (min)             |
| $V_{SDIL}$ | Shutdown Low Input Voltage      |  |                                 | 0.4          | V (max)             |
| $T_{WU}$   | Wake-up Time                    | $C_B = 1.0\mu\text{F}$   | 80                              | 110          | ms (max)            |
| $N_{OUT}$  | Output Noise                    | A-Weighted; Measured across 8 $\Omega$ BTL<br>Input terminated with 10 $\Omega$ to ground              | 26                              |              | $\mu\text{V}_{RMS}$ |

**Electrical Characteristics  $V_{DD} = 3.0V$**  (Notes 1, 2)

The following specifications apply for the circuit shown in Figure 1 unless otherwise specified. Limits apply for  $T_A = 25^\circ\text{C}$ .

| Symbol     | Parameter                       | Conditions   | LM4879                          |              | Units (Limits)      |
|------------|---------------------------------|--|---------------------------------|--------------|---------------------|
|            |                                 |  | Typical                         | Limit        |                     |
|            |                                 |  | (Note 6)                        | (Notes 7, 8) |                     |
| $I_{DD}$   | Quiescent Power Supply Current  | $V_{IN} = 0V, 8\Omega$ BTL   | 4.5                             | 9            | mA (max)            |
| $I_{SD}$   | Shutdown Current                | $V_{shutdown} = GND$   | 0.1                             | 2.0          | $\mu\text{A}$ (max) |
| $V_{OS}$   | Output Offset Voltage           |  | 5                               | 40           | mV (max)            |
| $P_o$      | Output Power                    | THD+N = 1% (max); f = 1kHz   | 350                             | 320          | mW                  |
| THD+N      | Total Harmonic Distortion+Noise | $P_o = 0.15W_{rms}$ ; f = 1kHz   | 0.1                             |              | %                   |
| PSRR       | Power Supply Rejection Ratio    | $V_{ripple} = 200mV_{sine}$ p-p, $C_B = 1.0\mu\text{F}$<br>Input terminated with 10 $\Omega$ to ground | 68 (f = 1kHz)<br>62 (f = 217Hz) | 55           | dB (min)            |
| $V_{SDIH}$ | Shutdown High Input Voltage     |  |                                 | 1.4          | V (min)             |
| $V_{SDIL}$ | Shutdown Low Input Voltage      |  |                                 | 0.4          | V (max)             |
| $T_{WU}$   | Wake-up Time                    | $C_B = 1.0\mu\text{F}$   | 80                              | 110          | ms (max)            |

## Electrical Characteristics $V_{DD} = 3.0V$ (Notes 1, 2)

The following specifications apply for the circuit shown in Figure 1 unless otherwise specified. Limits apply for  $T_A = 25^\circ C$ . (Continued)

| Symbol    | Parameter    | Conditions  | LM4879   |              | Units<br>(Limits) |
|-----------|--------------|---|----------|--------------|-------------------|
|           |              |   | Typical  | Limit        |                   |
|           |              |   | (Note 6) | (Notes 7, 8) |                   |
| $N_{OUT}$ | Output Noise | A-Weighted; Measured across 8Ω BTL<br>Input terminated with 10Ω to ground | 26       |              | $\mu V_{RMS}$     |

## Electrical Characteristics $V_{DD} = 2.6V$ (Notes 1, 2)

The following specifications apply for the circuit shown in Figure 1 unless otherwise specified. Limits apply for  $T_A = 25^\circ C$ .

| Symbol   | Parameter                       | Conditions   | LM4879                          |              | Units<br>(Limits) |
|----------|---------------------------------|--|---------------------------------|--------------|-------------------|
|          |                                 |  | Typical                         | Limit        |                   |
|          |                                 |  | (Note 6)                        | (Notes 7, 8) |                   |
| $I_{DD}$ | Quiescent Power Supply Current  | $V_{IN} = 0V$ , 8Ω BTL   | 3.5                             |              | mA                |
| $I_{SD}$ | Shutdown Current                | $V_{shutdown} = GND$   | 0.1                             |              | $\mu A$           |
| $V_{OS}$ | Output Offset Voltage           |  | 5                               |              | mV                |
| $P_o$    | Output Power                    | THD+N = 1% (max); f = 1kHz   |                                 |              | mW                |
|          |                                 | $R_L = 8\Omega$  | 250                             |              |                   |
|          |                                 | $R_L = 4\Omega$  | 350                             |              |                   |
| THD+N    | Total Harmonic Distortion+Noise | $P_o = 0.1W_{rms}$ ; f = 1kHz  | 0.1                             |              | %                 |
| PSRR     | Power Supply Rejection Ratio    | $V_{ripple} = 200mV_{sine}$ p-p, $C_B = 1.0\mu F$<br>Input terminated with 10Ω to ground | 55 (f = 1kHz)<br>55 (f = 217Hz) |              | dB                |

**Note 1:** All voltages are measured with respect to the ground pin, unless otherwise specified.

**Note 2:** *Absolute Maximum Ratings* indicate limits beyond which damage to the device may occur. *Operating Ratings* indicate conditions for which the device is functional, but do not guarantee specific performance limits. *Electrical Characteristics* state DC and AC electrical specifications under particular test conditions which guarantee specific performance limits. This assumes that the device is within the Operating Ratings. Specifications are not guaranteed for parameters where no limit is given, however, the typical value is a good indication of device performance.

**Note 3:** The maximum power dissipation must be derated at elevated temperatures and is dictated by  $T_{JMAX}$ ,  $\theta_{JA}$ , and the ambient temperature  $T_A$ . The maximum allowable power dissipation is  $P_{DMAX} = (T_{JMAX} - T_A) / \theta_{JA}$  or the number given in Absolute Maximum Ratings, whichever is lower. For the LM4879, see power derating curves for additional information.

**Note 4:** Human body model, 100pF discharged through a 1.5kΩ resistor.

**Note 5:** Machine Model, 220pF–240pF discharged through all pins.

**Note 6:** Typical values are measured at 25°C and represent the parametric norm.

**Note 7:** Limits are guaranteed to National's AOQL (Average Outgoing Quality Level).

**Note 8:** For micro SMD only, shutdown current is measured in a Normal Room Environment. Exposure to direct sunlight will increase  $I_{SD}$  by a maximum of 2μA.

**Note 9:** If the product is in shutdown mode, and  $V_{DD}$  exceeds 6V (to a max of 8V  $V_{DD}$ ), then most of the excess current will flow through the ESD protection circuits. If the source impedance limits the current to a max of 10mA, then the part will be protected. If the part is enabled when  $V_{DD}$  is above 6V, circuit performance will be curtailed or the part may be permanently damaged.

**Note 10:** All bumps have the same thermal resistance and contribute equally when used to lower thermal resistance.

**Note 11:** Maximum power dissipation ( $P_{DMAX}$ ) in the device occurs at an output power level significantly below full output power.  $P_{DMAX}$  can be calculated using Equation 1 shown in the Application section. It may also be obtained from the power dissipation graphs.

**Note 12:** The stated  $\theta_{JA}$  is achieved when the LLP package's DAP is soldered to a 4in<sup>2</sup> copper heatsink plain.

## External Components Description

(Figure 1)

| Components |       | Functional Description   |
|------------|-------|--|
| 1.         | $R_i$ | Inverting input resistance which sets the closed-loop gain in conjunction with $R_f$ . This resistor also forms a high pass filter with $C_i$ at $f_c = 1/(2\pi R_i C_i)$ .  |
| 2.         | $C_i$ | Input coupling capacitor which blocks the DC voltage at the amplifiers input terminals. Also creates a highpass filter with $R_i$ at $f_c = 1/(2\pi R_i C_i)$ . Refer to the section, <b>Proper Selection of External Components</b> , for an explanation of how to determine the value of $C_i$ . |
| 3.         | $R_f$ | Feedback resistance which sets the closed-loop gain in conjunction with $R_i$ .  |
| 4.         | $C_S$ | Supply bypass capacitor which provides power supply filtering. Refer to the <b>Power Supply Bypassing</b> section for information concerning proper placement and selection of the supply bypass capacitor.  |
| 5.         | $C_B$ | Bypass pin capacitor which provides half-supply filtering. Refer to the section, <b>Proper Selection of External Components</b> , for information concerning proper placement and selection of $C_B$ .   |

# Typical Performance Characteristics

**THD+N vs Frequency**  
 $V_{DD} = 5V, R_L = 8\Omega, PWR = 250mW$

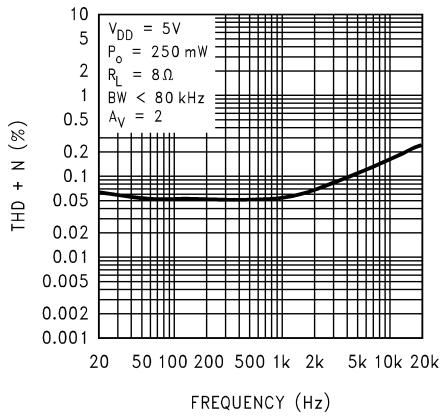

**THD+N vs Frequency**  
 $V_{DD} = 3V, R_L = 8\Omega, PWR = 150mW$

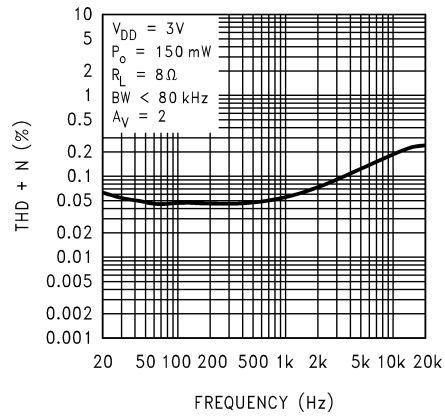

**THD+N vs Frequency**  
 $V_{DD} = 2.6V, R_L = 8\Omega, PWR = 100mW$

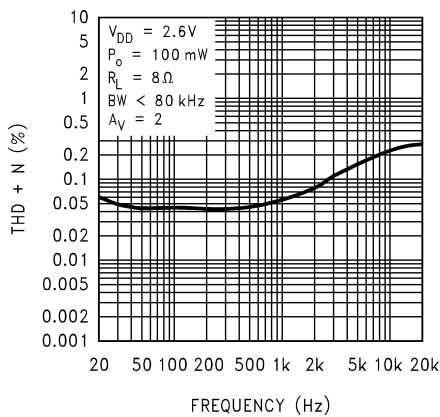

**THD+N vs Frequency**  
 $V_{DD} = 2.6V, R_L = 4\Omega, PWR = 100mW$

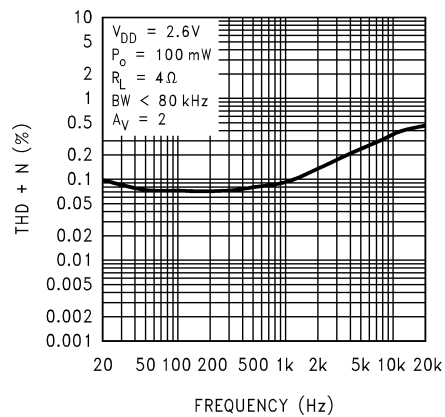

**THD+N vs Power Out**  
 $V_{DD} = 5V, R_L = 8\Omega, f = 1kHz$

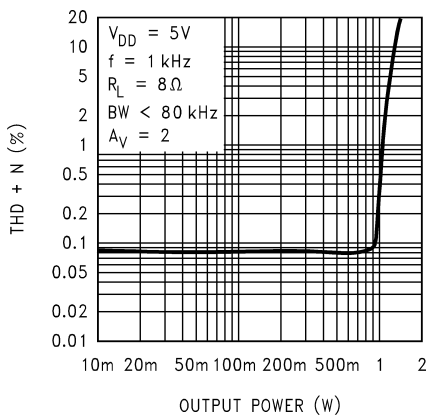

**THD+N vs Power Out**  
 $V_{DD} = 3V, R_L = 8\Omega, f = 1kHz$

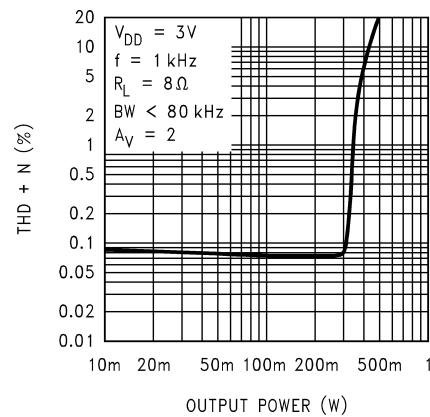

# Typical Performance Characteristics (Continued)

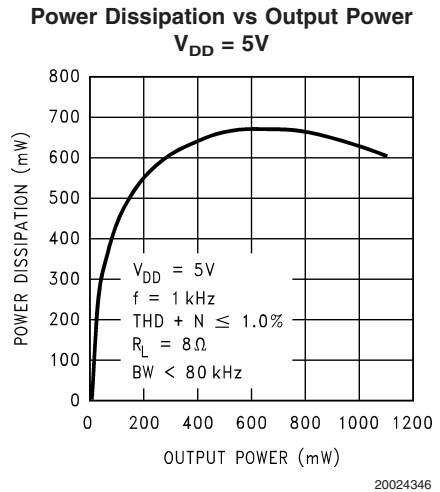
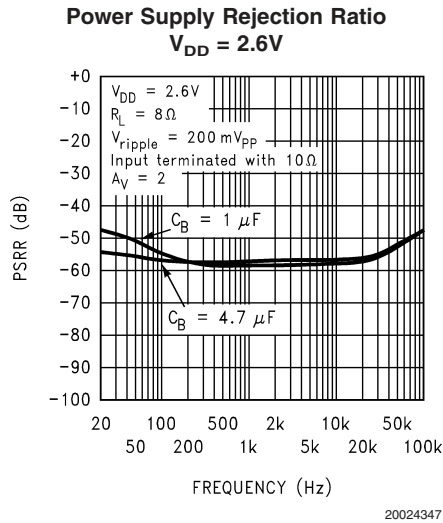
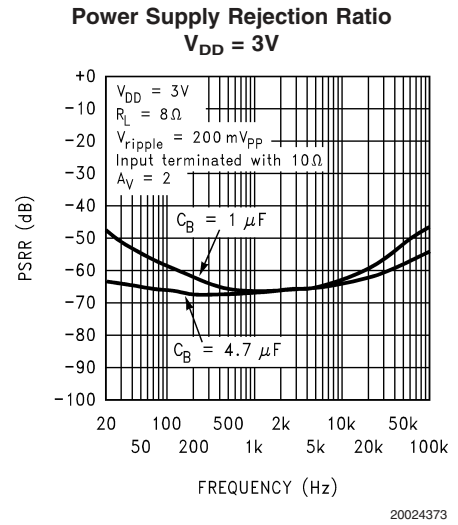
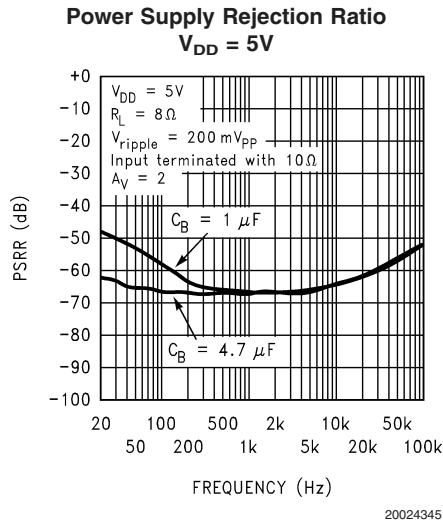
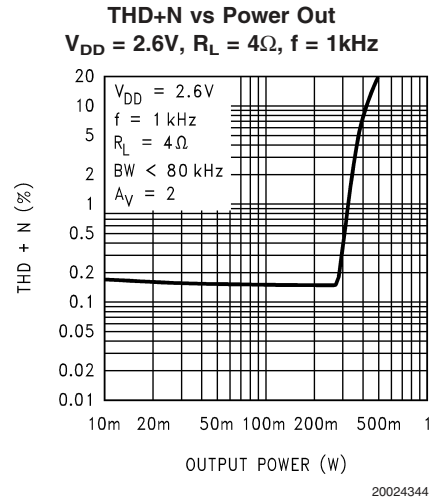
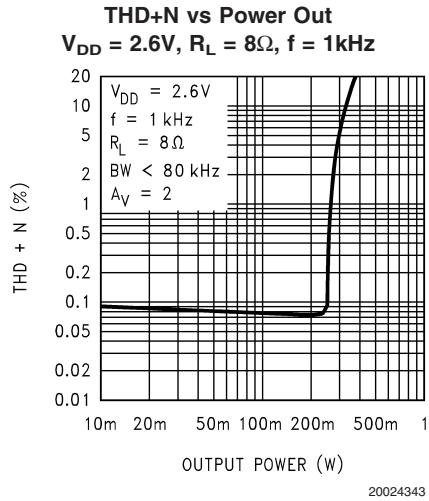



Typical Performance Characteristics (Continued)

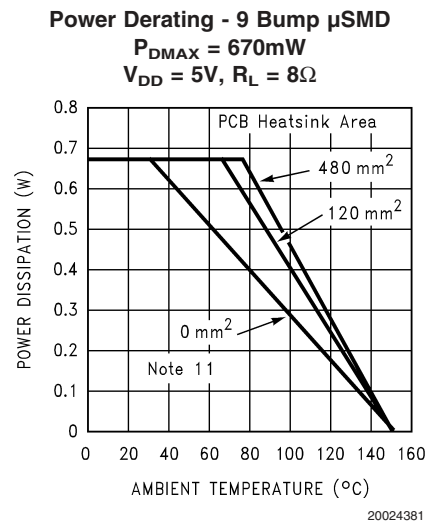
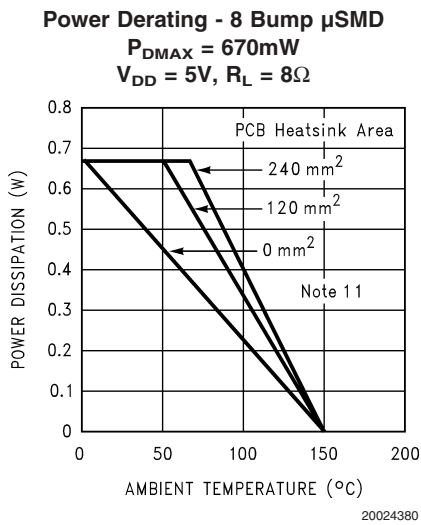
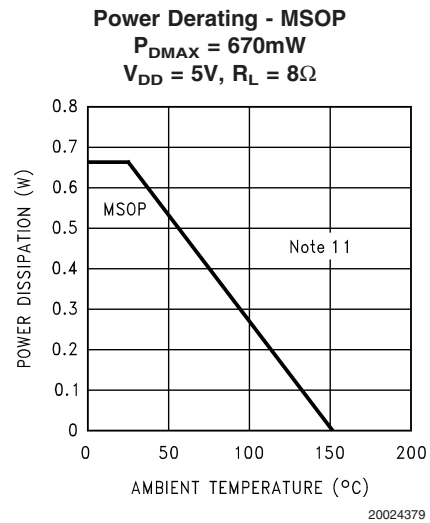
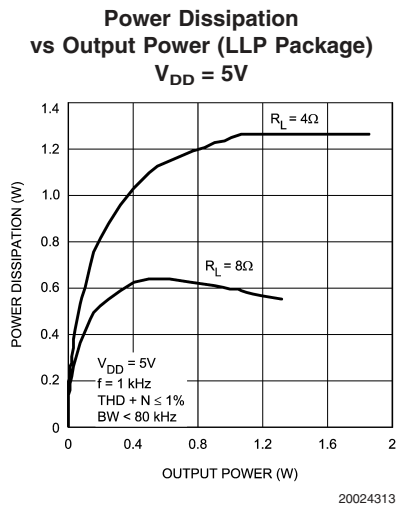
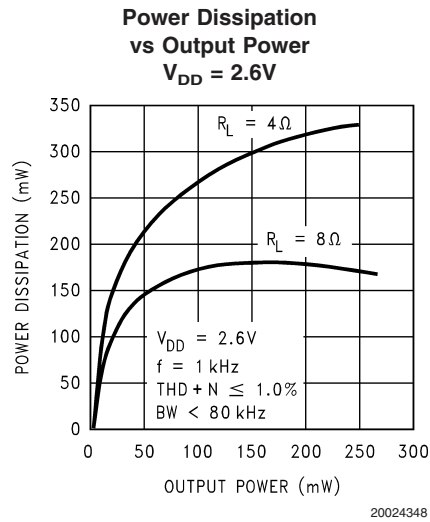
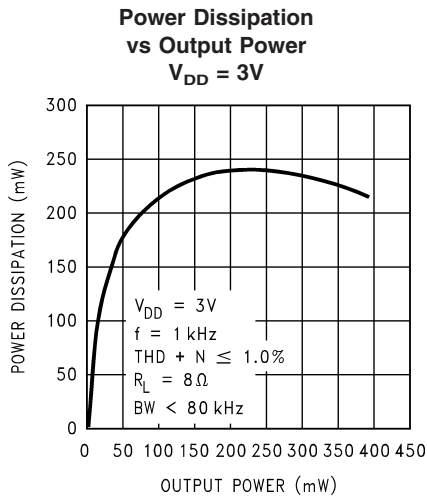

# Typical Performance Characteristics (Continued)

## Power Derating - LLP

$P_{DMAX} = 670mW$   
 $V_{DD} = 5V, R_L = 8$

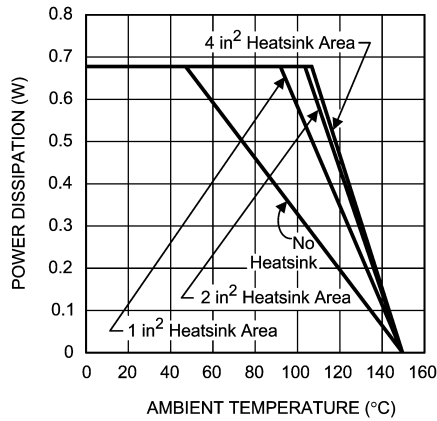

200243B4

## Output Power vs Supply Voltage

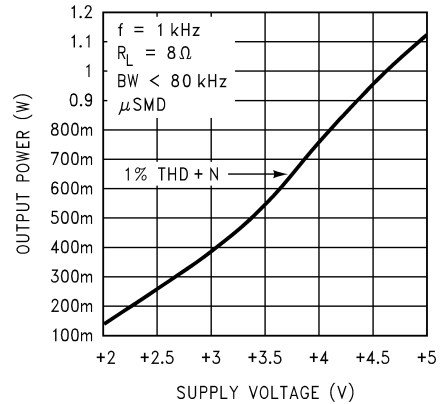

20024351

## Output Power vs Supply Voltage

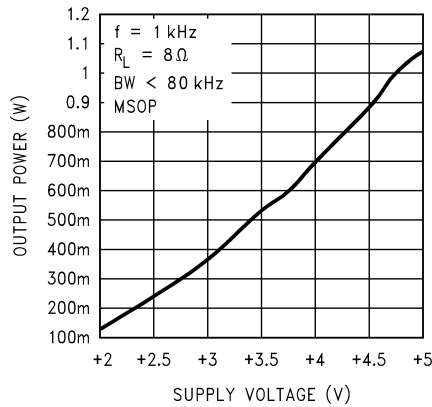

20024350

## Output Power vs Load Resistance

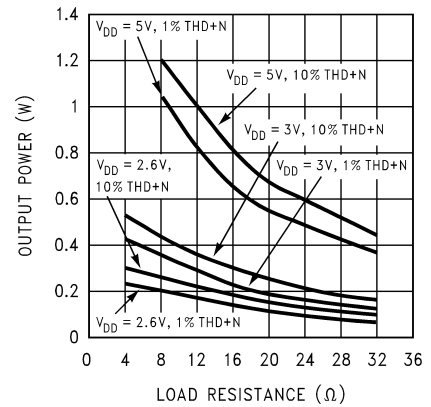

20024374

## Clipping (Dropout) Voltage vs Supply Voltage

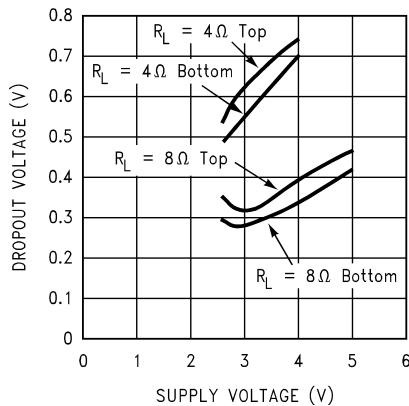

20024352

## Supply Current Shutdown Voltage

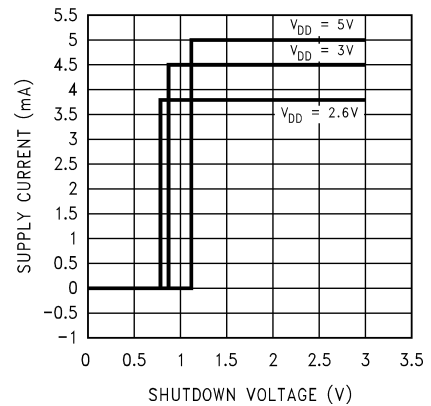

20024375

# Typical Performance Characteristics (Continued)

**Shutdown Hysteresis Voltage**  
 $V_{DD} = 5V$

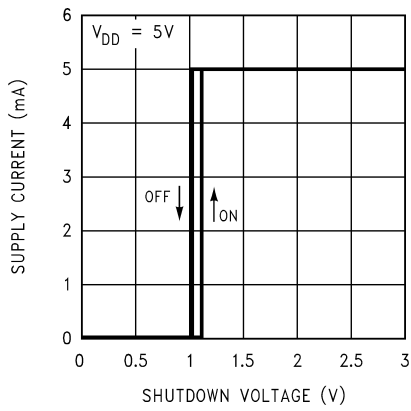

**Shutdown Hysteresis Voltage**  
 $V_{DD} = 3V$

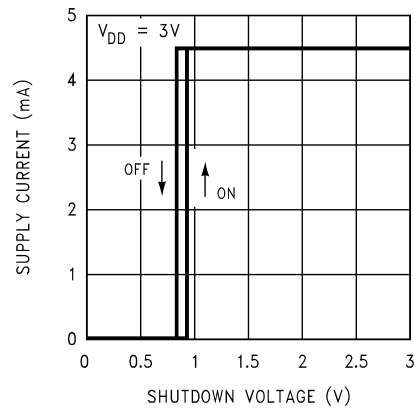

**Shutdown Hysteresis Voltage**  
 $V_{DD} = 2.6V$

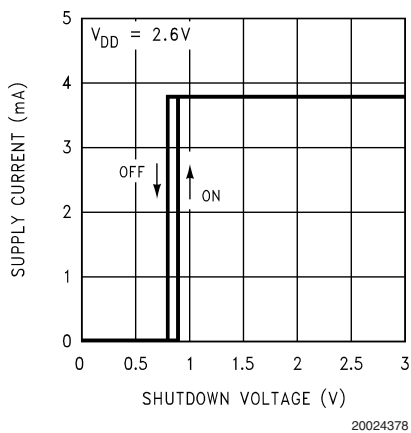

**Open Loop**  
**Frequency Response**

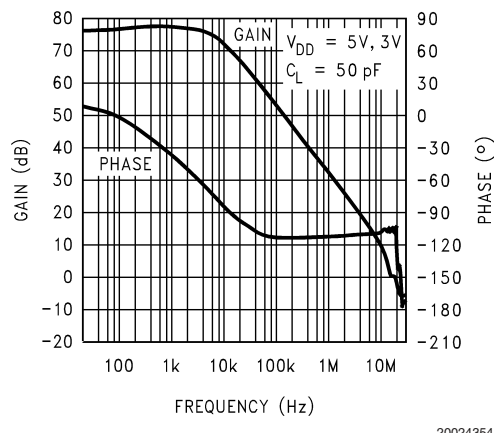

**Frequency Response**  
**vs Input Capacitor Size**

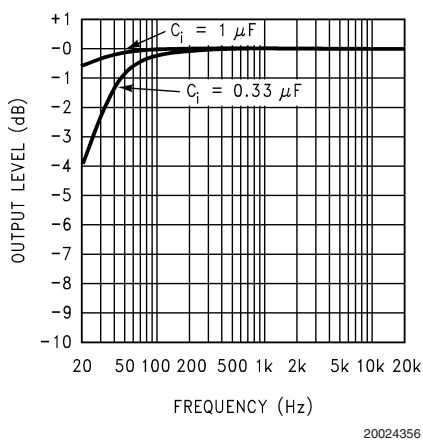

## Application Information

### BRIDGE CONFIGURATION EXPLANATION

As shown in *Figure 1*, the LM4879 has two operational amplifiers internally, allowing for a few different amplifier configurations. The first amplifier's gain is externally configurable, while the second amplifier is internally fixed in a unity-gain, inverting configuration. The closed-loop gain of the first amplifier is set by selecting the ratio of  $R_f$  to  $R_i$  while the second amplifier's gain is fixed by the two internal 20 k $\Omega$  resistors. *Figure 1* shows that the output of amplifier one serves as the input to amplifier two which results in both amplifiers producing signals identical in magnitude, but out of phase by 180°. Consequently, the differential gain for the IC is

$$A_{VD} = 2 * (R_f/R_i)$$

By driving the load differentially through outputs Vo1 and Vo2, an amplifier configuration commonly referred to as "bridged mode" is established. Bridged mode operation is different from the classical single-ended amplifier configuration where one side of the load is connected to ground.

A bridge amplifier design has a few distinct advantages over the single-ended configuration, as it provides differential drive to the load, thus doubling output swing for a specified supply voltage. Four times the output power is possible as compared to a single-ended amplifier under the same conditions. This increase in attainable output power assumes that the amplifier is not current limited or clipped. In order to choose an amplifier's closed-loop gain without causing excessive clipping, please refer to the **Audio Power Amplifier Design** section.

A bridge configuration, such as the one used in LM4879, also creates a second advantage over single-ended amplifiers. Since the differential outputs, Vo1 and Vo2, are biased at half-supply, no net DC voltage exists across the load. This eliminates the need for an output coupling capacitor which is required in a single supply, single-ended amplifier configuration. Without an output coupling capacitor, the half-supply bias across the load would result in both increased internal IC power dissipation and also possible loudspeaker damage.

### POWER DISSIPATION

Power dissipation is a major concern when designing a successful amplifier, whether the amplifier is bridged or single-ended. A direct consequence of the increased power delivered to the load by a bridge amplifier is an increase in internal power dissipation. Since the LM4879 has two operational amplifiers in one package, the maximum internal power dissipation is 4 times that of a single-ended amplifier. The maximum power dissipation for a given application can be derived from the power dissipation graphs or from Equation 1.

$$P_{DMAX} = 4 * (V_{DD})^2 / (2\pi^2 R_L) \quad (1)$$

It is critical that the maximum junction temperature ( $T_{JMAX}$ ) of 150°C is not exceeded.  $T_{JMAX}$  can be determined from the power derating curves by using  $P_{DMAX}$  and the PC board foil area. By adding additional copper foil, the thermal resistance of the application can be reduced from a free air value of 150°C/W, resulting in higher  $P_{DMAX}$ . Additional copper foil can be added to any of the leads connected to the LM4879. It is especially effective when connected to  $V_{DD}$ , GND, and the output pins. Refer to the application information on the LM4879 reference design board for an example of good heat sinking. If  $T_{JMAX}$  still exceeds 150°C, then additional changes must be made. These changes can include re-

duced supply voltage, higher load impedance, or reduced ambient temperature. Internal power dissipation is a function of output power. Refer to the **Typical Performance Characteristics** curves for power dissipation information for different output powers and output loading.

### POWER SUPPLY BYPASSING

As with any amplifier, proper supply bypassing is critical for low noise performance and high power supply rejection. The capacitor location on both the bypass and power supply pins should be as close to the device as possible. Typical applications employ a 5V regulator with 10  $\mu$ F tantalum or electrolytic capacitor and a ceramic bypass capacitor which aid in supply stability. This does not eliminate the need for bypassing the supply nodes of the LM4879. The selection of a bypass capacitor, especially  $C_B$ , is dependent upon PSRR requirements, click and pop performance (as explained in the section, **Proper Selection of External Components**), system cost, and size constraints.

### SHUTDOWN FUNCTION

In order to reduce power consumption while not in use, the LM4879 contains a shutdown pin to externally turn off the amplifier's bias circuitry. This shutdown feature turns the amplifier off when a logic low is placed on the shutdown pin. By switching the shutdown pin to ground, the LM4879 supply current draw will be minimized in idle mode. While the device will be disabled with shutdown pin voltages less than 0.4V<sub>DC</sub>, the idle current may be greater than the typical value of 0.1 $\mu$ A. (Idle current is measured with the shutdown pin tied to ground).

In many applications, a microcontroller or microprocessor output is used to control the shutdown circuitry to provide a quick, smooth transition into shutdown. Another solution is to use a single-pole, single-throw switch in conjunction with an external pull-up resistor. When the switch is closed, the shutdown pin is connected to ground which disables the amplifier. If the switch is open, then the external pull-up resistor to  $V_{DD}$  will enable the LM4879. This scheme guarantees that the shutdown pin will not float thus preventing unwanted state changes.

### PROPER SELECTION OF EXTERNAL COMPONENTS

Proper selection of external components in applications using integrated power amplifiers is critical to optimize device and system performance. While the LM4879 is tolerant of external component combinations, consideration to component values must be used to maximize overall system quality.

The LM4879 is unity-gain stable which gives the designer maximum system flexibility. The LM4879 should be used in low gain configurations to minimize THD+N values, and maximize the signal to noise ratio. Low gain configurations require large input signals to obtain a given output power. Input signals equal to or greater than 1 V<sub>rms</sub> are available from sources such as audio codecs. Please refer to the section, **Audio Power Amplifier Design**, for a more complete explanation of proper gain selection.

Besides gain, one of the major considerations is the closed-loop bandwidth of the amplifier. To a large extent, the bandwidth is dictated by the choice of external components shown in *Figure 1*. The input coupling capacitor,  $C_i$ , forms a first order high pass filter which limits low frequency response. This value should be chosen based on needed frequency response for a few distinct reasons.

## Application Information (Continued)

### Selection Of Input Capacitor Size

Large input capacitors are both expensive and space hungry for portable designs. Clearly, a certain sized capacitor is needed to couple in low frequencies without severe attenuation. But in many cases the speakers used in portable systems, whether internal or external, have little ability to reproduce signals below 100 Hz to 150 Hz. Thus, using a large input capacitor may not increase actual system performance.

In addition to system cost and size, click and pop performance is effected by the size of the input coupling capacitor,  $C_i$ . A larger input coupling capacitor requires more charge to reach its quiescent DC voltage (nominally  $1/2 V_{DD}$ ). This charge comes from the output via the feedback and is apt to create pops upon device enable. Thus, by minimizing the capacitor size based on necessary low frequency response, turn-on pops can be minimized.

Besides minimizing the input capacitor size, careful consideration should be paid to the bypass capacitor value. Bypass capacitor,  $C_B$ , is the most critical component to minimize turn-on pops since it determines how fast the LM4879 turns on. The slower the LM4879's outputs ramp to their quiescent DC voltage (nominally  $1/2 V_{DD}$ ), the smaller the turn-on pop. Choosing  $C_B$  equal to  $1.0 \mu\text{F}$  along with a small value of  $C_i$  (in the range of  $0.1 \mu\text{F}$  to  $0.39 \mu\text{F}$ ), should produce a virtually clickless and popless shutdown function. While the device will function properly, (no oscillations or motorboating), with  $C_B$  equal to  $0.1 \mu\text{F}$ , the device will be much more susceptible to turn-on clicks and pops. Thus, a value of  $C_B$  equal to  $1.0 \mu\text{F}$  is recommended in all but the most cost sensitive designs.

### AUDIO POWER AMPLIFIER DESIGN

#### A 1W/8Ω Audio Amplifier

Given:

|                 |                             |
|-----------------|-----------------------------|
| Power Output    | 1 Wrms                      |
| Load Impedance  | 8Ω                          |
| Input Level     | 1 Vrms                      |
| Input Impedance | 20 kΩ                       |
| Bandwidth       | 100 Hz–20 kHz $\pm$ 0.25 dB |

A designer must first determine the minimum supply rail to obtain the specified output power. By extrapolating from the Output Power vs Supply Voltage graphs in the **Typical Performance**

**Characteristics** section, the supply rail can be easily found. A second way to determine the minimum supply rail is to calculate the required  $V_{\text{opeak}}$  using Equation 2 and add the output voltage. Using this method, the minimum supply voltage would be  $(V_{\text{opeak}} + (V_{\text{ODTOP}} + V_{\text{ODBOT}}))$ , where  $V_{\text{ODBOT}}$  and  $V_{\text{ODTOP}}$  are extrapolated from the Dropout Voltage vs Supply Voltage curve in the **Typical Performance Characteristics** section.

$$V_{\text{opeak}} = \sqrt{(2R_L P_O)} \quad (2)$$

5V is a standard voltage, in most applications, chosen for the supply rail. Extra supply voltage creates headroom that allows the LM4879 to reproduce peaks in excess of 1W without producing audible distortion. At this time, the designer must make sure that the power supply choice along with the output impedance does not violate the conditions explained in the **Power Dissipation** section.

Once the power dissipation equations have been addressed, the required differential gain can be determined from Equation 3.

$$A_{VD} \geq \sqrt{(P_O R_L)} / (V_{IN}) = V_{\text{orms}} / V_{\text{inrms}} \quad (3)$$

$$A_{VD} = (R_f / R_i) \cdot 2$$

From Equation 3, the minimum  $A_{VD}$  is 2.83; use  $A_{VD} = 3$ .

Since the desired input impedance was 20 kΩ, and with a  $A_{VD}$  of 3, a ratio of 1.5:1 of  $R_f$  to  $R_i$  results in an allocation of  $R_i = 20 \text{ k}\Omega$  and  $R_f = 30 \text{ k}\Omega$ . The final design step is to address the bandwidth requirements which must be stated as a pair of  $-3 \text{ dB}$  frequency points. Five times away from a  $-3 \text{ dB}$  point is 0.17 dB down from passband response which is better than the required  $\pm 0.25 \text{ dB}$  specified.

$$f_L = 100 \text{ Hz} / 5 = 20 \text{ Hz}$$

$$f_H = 20 \text{ kHz} \cdot 5 = 100 \text{ kHz}$$

As stated in the **External Components** section,  $R_i$  in conjunction with  $C_i$  create a highpass filter.

$$C_i \geq 1 / (2\pi \cdot 20 \text{ k}\Omega \cdot 20 \text{ Hz}) = 0.397 \mu\text{F}; \text{ use } 0.39 \mu\text{F}$$

The high frequency pole is determined by the product of the desired frequency pole,  $f_H$ , and the differential gain,  $A_{VD}$ . With a  $A_{VD} = 3$  and  $f_H = 100 \text{ kHz}$ , the resulting GBWP = 300 kHz which is much smaller than the LM4879 GBWP of 10 MHz. This figure displays that if a designer has a need to design an amplifier with a higher differential gain, the LM4879 can still be used without running into bandwidth limitations.

## Application Information (Continued)

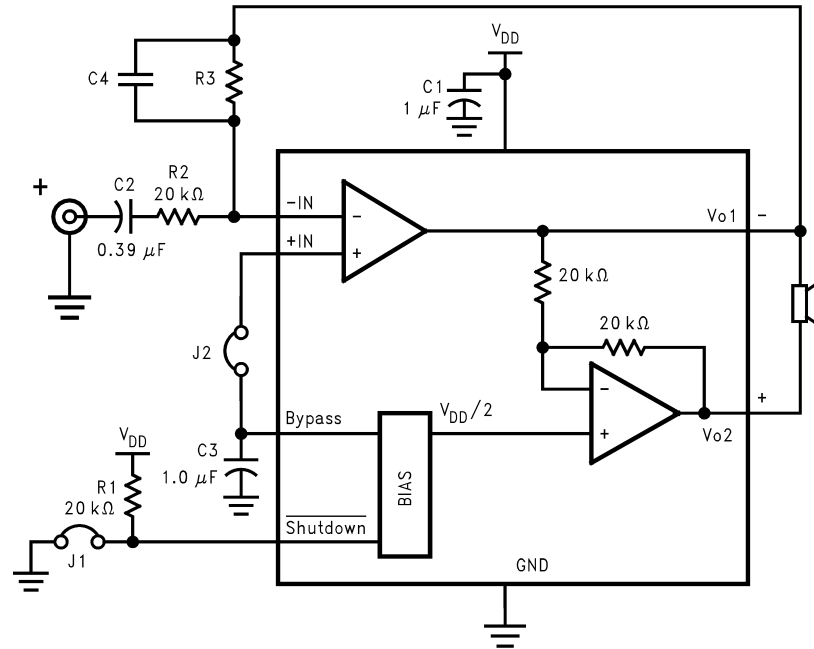

20024388

FIGURE 2. HIGHER GAIN AUDIO AMPLIFIER

The LM4879 is unity-gain stable and requires no external components besides gain-setting resistors, an input coupling capacitor, and proper supply bypassing in the typical application. However, if a closed-loop differential gain of greater than 10 is required, a feedback capacitor ( $C_4$ ) may be needed as shown in Figure 2 to bandwidth limit the amplifier. This feedback capacitor creates a low pass filter that elimi-

nates possible high frequency oscillations. Care should be taken when calculating the -3dB frequency in that an incorrect combination of  $R_3$  and  $C_4$  will cause rolloff before 20kHz. A typical combination of feedback resistor and capacitor that will not produce audio band high frequency rolloff is  $R_3 = 20k\Omega$  and  $C_4 = 25pF$ . These components result in a -3dB point of approximately 320 kHz.

Application Information (Continued)

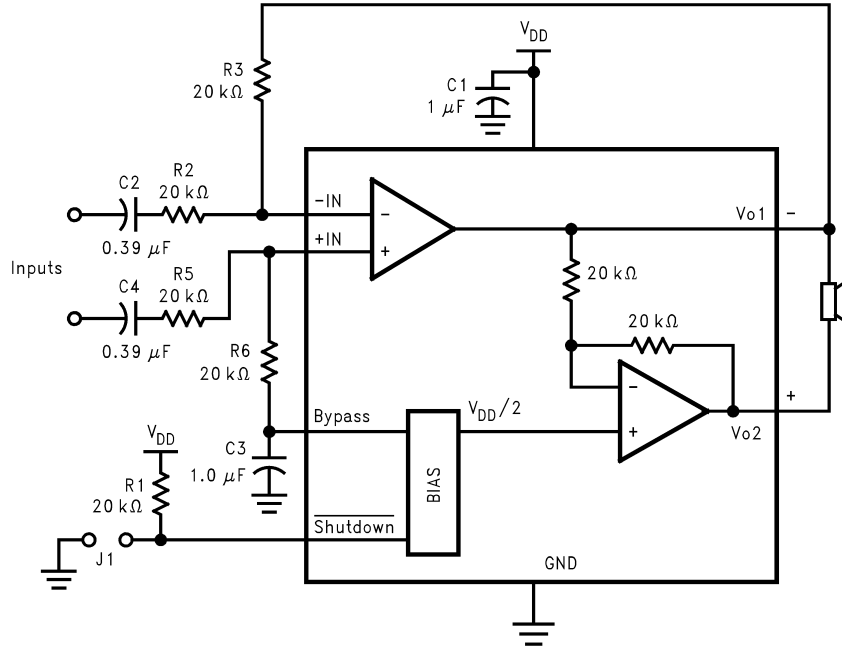

20024389

FIGURE 3. DIFFERENTIAL AMPLIFIER CONFIGURATION FOR LM4879

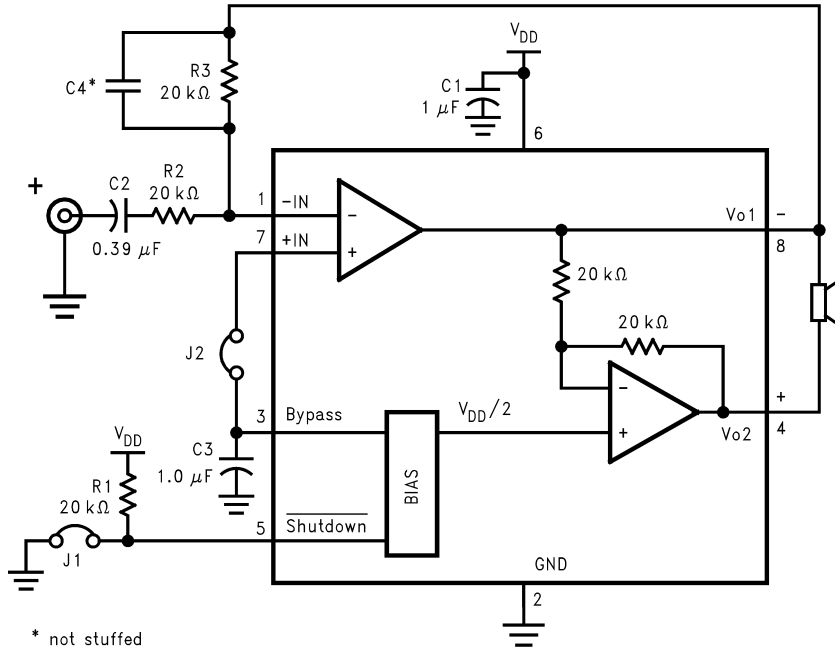

20024390

FIGURE 4. REFERENCE DESIGN BOARD and LAYOUT - micro SMD

## Application Information (Continued)

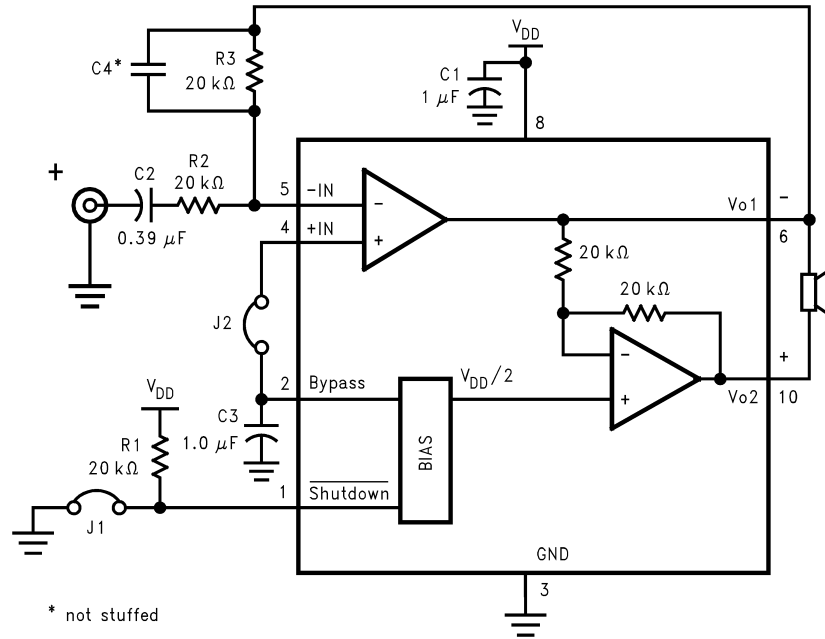

FIGURE 5. REFERENCE DESIGN BOARD and PCB LAYOUT GUIDELINES - MSOP &amp; SO Boards



# Application Information (Continued)

## LM4879 micro SMD BOARD ARTWORK

Silk Screen

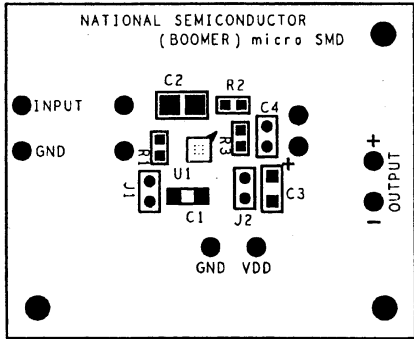

20024357

Top Layer

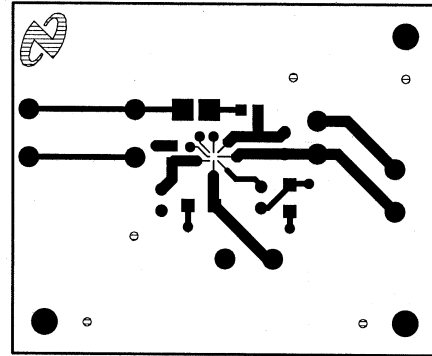

20024358

Bottom Layer

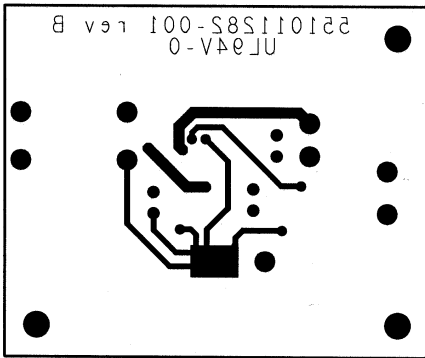

20024359

Inner Layer Ground

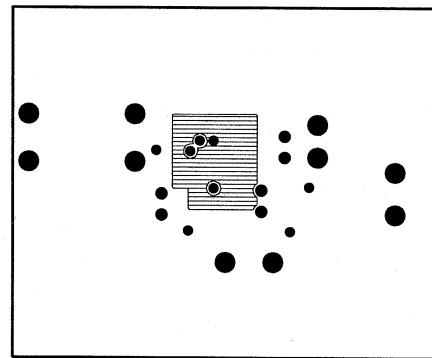

20024360

Inner Layer V<sub>DD</sub>

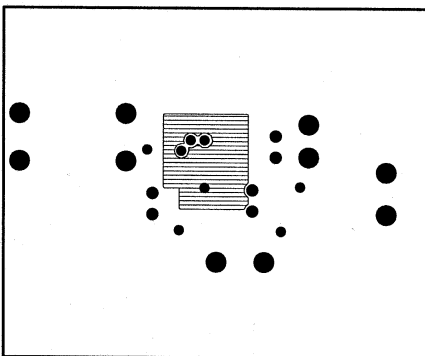

20024361

# Application Information (Continued)

## LM4879 MSOP DEMO BOARD ARTWORK

### Silk Screen

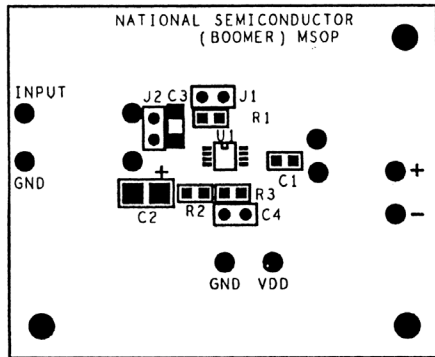

20024365

### Top Layer

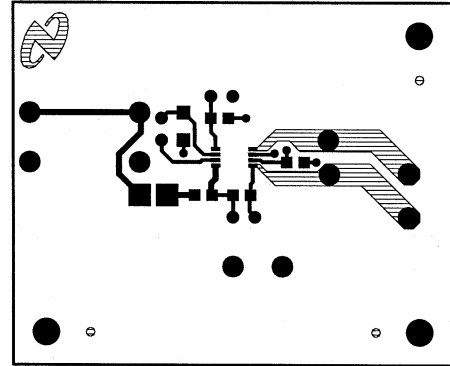

20024366

### Bottom Layer

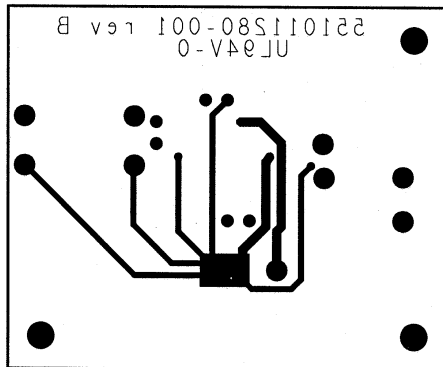

20024367

### TABLE 1. Mono LM4879 Reference Design Boards Bill of Material for all 3 Demo Boards

| Item | Part Number   | Part Description                       | Qty | Ref Designator |
|------|---------------|--|-----|----------------|
| 1    | 551011208-001 | LM4879 Mono Reference Design Board     | 1   |                |
| 10   | 482911183-001 | LM4879 Audio AMP                       | 1   | U1             |
| 20   | 151911207-001 | Tant Cap 1uF 16V 10                    | 1   | C1             |
| 21   | 151911207-002 | Cer Cap 0.39uF 50V Z5U 20% 1210        | 1   | C2             |
| 25   | 152911207-001 | Tant Cap 1.0uF 16V 10                  | 1   | C3             |
| 30   | 472911207-001 | Res 20K Ohm 1/10W 5                    | 3   | R1, R2, R3     |
| 35   | 210007039-002 | Jumper Header Vertical Mount 2X1 0.100 | 2   | J1, J2         |

# Application Information (Continued)

## LM4879 LLP DEMO BOARD ARTWORK

Silk Screen

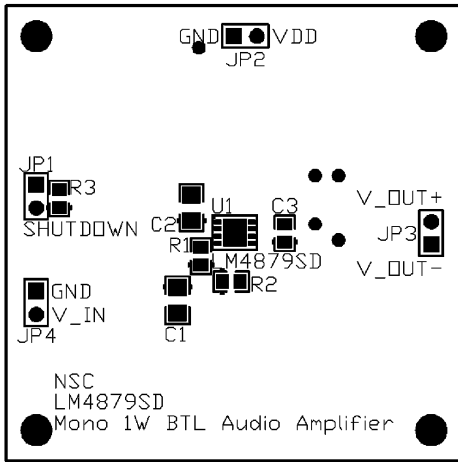

200243C2

Top Layer

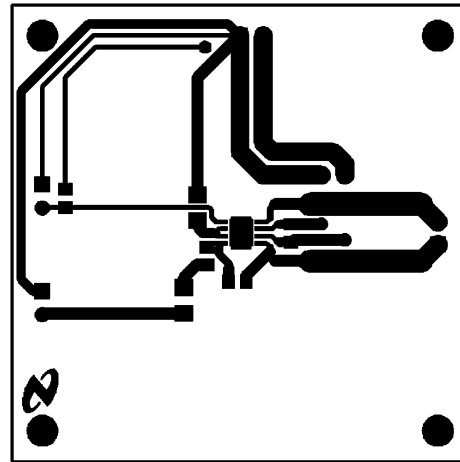

200243C0

Bottom Layer

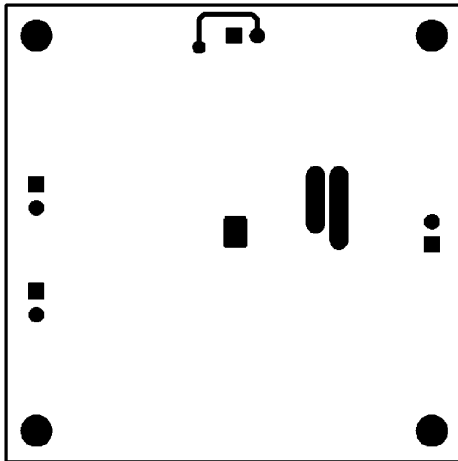

200243C1

## Application Information (Continued)

### PCB LAYOUT GUIDELINES

This section provides practical guidelines for mixed signal PCB layout that involves various digital/analog power and ground traces. Designers should note that these are only "rule-of-thumb" recommendations and the actual results will depend heavily on the final layout.

#### General Mixed Signal Layout Recommendation

##### Power and Ground Circuits

For 2 layer mixed signal design, it is important to isolate the digital power and ground trace paths from the analog power and ground trace paths. Star trace routing techniques (bringing individual traces back to a central point rather than daisy chaining traces together in a serial manner) can have a major impact on low level signal performance. Star trace routing refers to using individual traces to feed power and ground to each circuit or even device. This technique will take require a greater amount of design time but will not increase the final price of the board. The only extra parts required may be some jumpers.

##### Single-Point Power / Ground Connections

The analog power traces should be connected to the digital traces through a single point (link). A "Pi-filter" can be helpful in minimizing high frequency noise coupling between the analog and digital sections. It is further recommended to put digital and analog power traces over the corresponding digital and analog ground traces to minimize noise coupling.

##### Placement of Digital and Analog Components

All digital components and high-speed digital signals traces should be located as far away as possible from analog components and circuit traces.

##### Avoiding Typical Design / Layout Problems

Avoid ground loops or running digital and analog traces parallel to each other (side-by-side) on the same PCB layer. When traces must cross over each other do it at 90 degrees. Running digital and analog traces at 90 degrees to each other from the top to the bottom side as much as possible will minimize capacitive noise coupling and cross talk.

**Physical Dimensions** inches (millimeters) unless otherwise noted

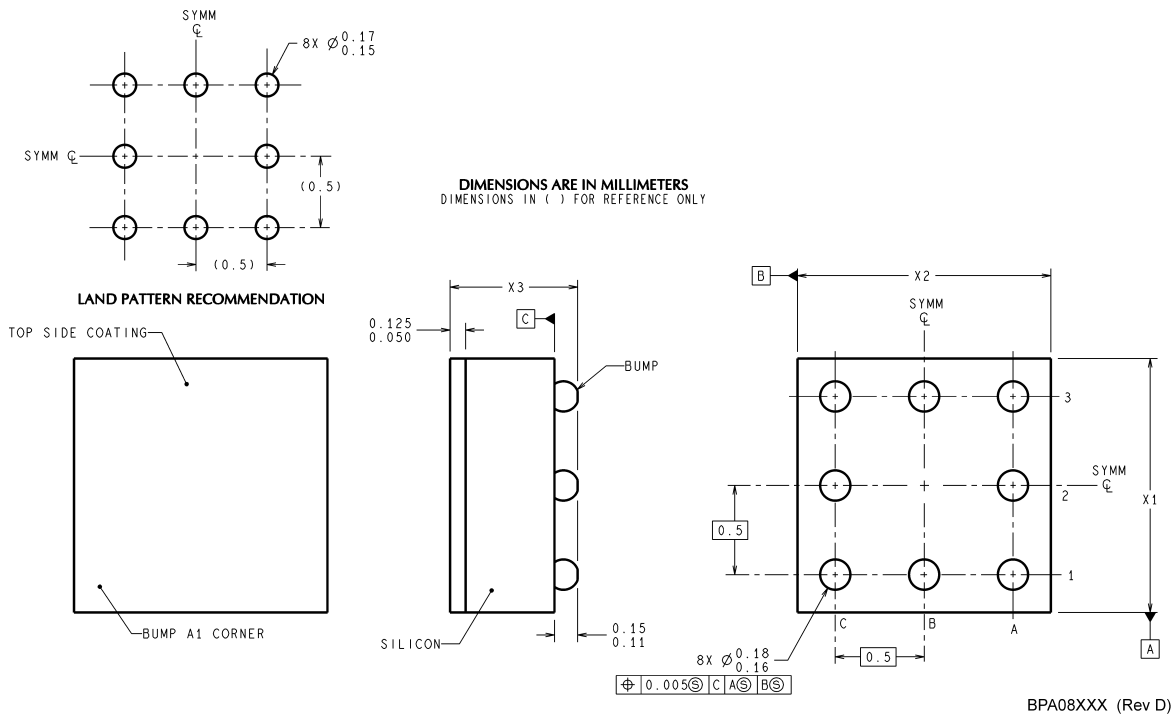

**Note:** Unless otherwise specified.

1. Epoxy coating.
2. 63Sn/37Pb eutectic bump.
3. Recommend non-solder mask defined landing pad.
4. Pin 1 is established by lower left corner with respect to text orientation pins are numbered counterclockwise.
5. Reference JEDEC registration MO-211, variation BC.

**8-Bump micro SMD**  
**Order Number LM4879IBP, LM4879IBPX**  
**NS Package Number BPA08DDB**  
**X1 = 1.361±0.03 X2 = 1.361±0.03 X3 = 0.850±0.10**

**Physical Dimensions** inches (millimeters) unless otherwise noted (Continued)

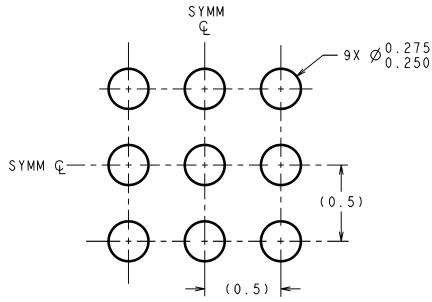

**LAND PATTERN RECOMMENDATION**

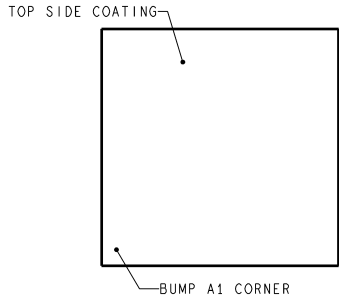

**DIMENSIONS ARE IN MILLIMETERS**  
DIMENSIONS IN ( ) FOR REFERENCE ONLY

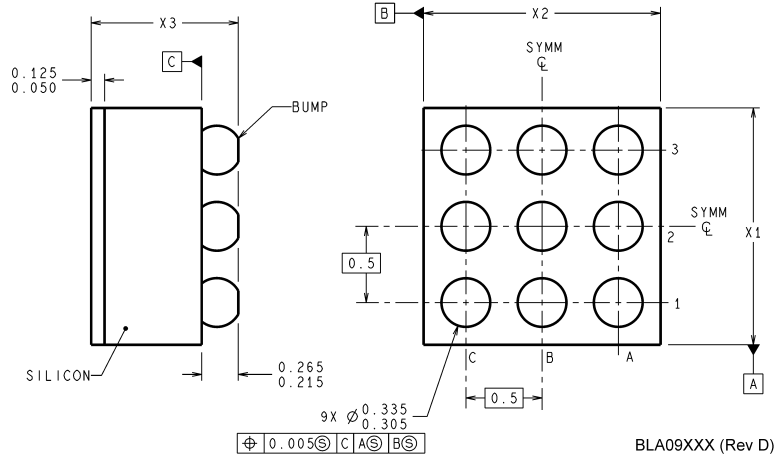

BLA09XXX (Rev D)

**Note:** Unless otherwise specified.

1. Epoxy coating.
2. 63Sn/37Pb eutectic bump.
3. Recommend non-solder mask defined landing pad.
4. Pin 1 is established by lower left corner with respect to text orientation pins are numbered counterclockwise.
5. Reference JEDEC registration MO-211, variation BC.

**9-Bump micro SMD**  
**Order Number LM4879IBL, LM4879IBLX**  
**NS Package Number BLA09AAB**  
**X1 = 1.514±0.03 X2 = 1.514±0.03 X3 = 0.945±0.10**

**Physical Dimensions** inches (millimeters) unless otherwise noted (Continued)

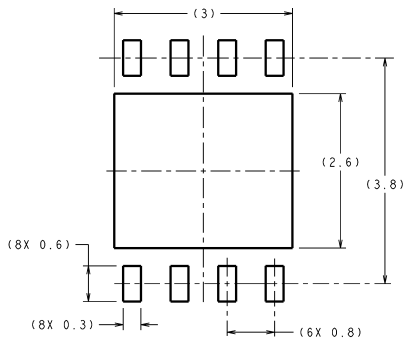

RECOMMENDED LAND PATTERN

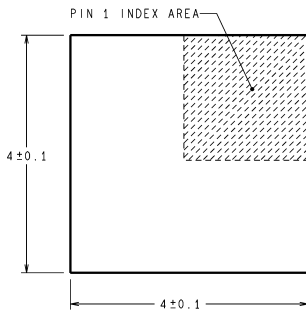

DIMENSIONS ARE IN MILLIMETERS  
DIMENSIONS IN ( ) FOR REFERENCE ONLY

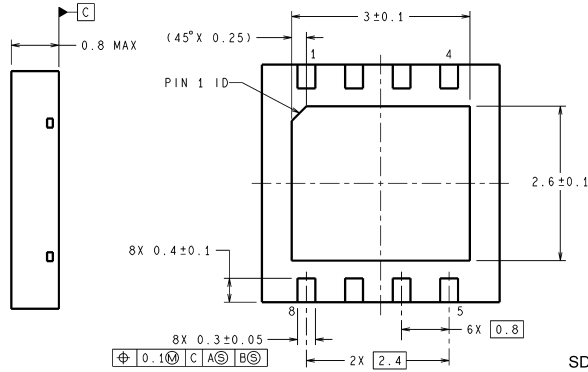

SDC08A (Rev A)

**LLP**  
**Order Number LM4879SD**  
**NS Package Number SDC08A**

**Physical Dimensions** inches (millimeters) unless otherwise noted (Continued)

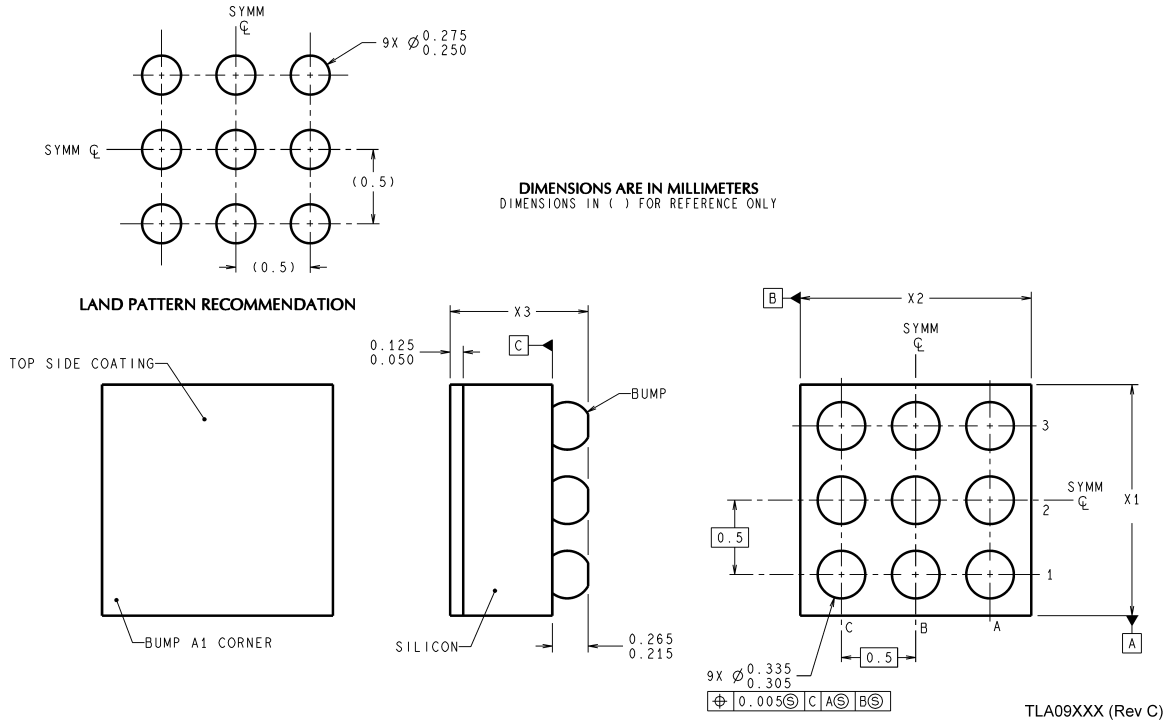

**9-Bump micro SMD**  
**Order Number LM4879ITL LM4879ITLX**  
**NS Package Number TLA09AAA**  
**X1 = 1.514±0.03 X2 = 1.514±0.03 X3 = 0.60±0.075**

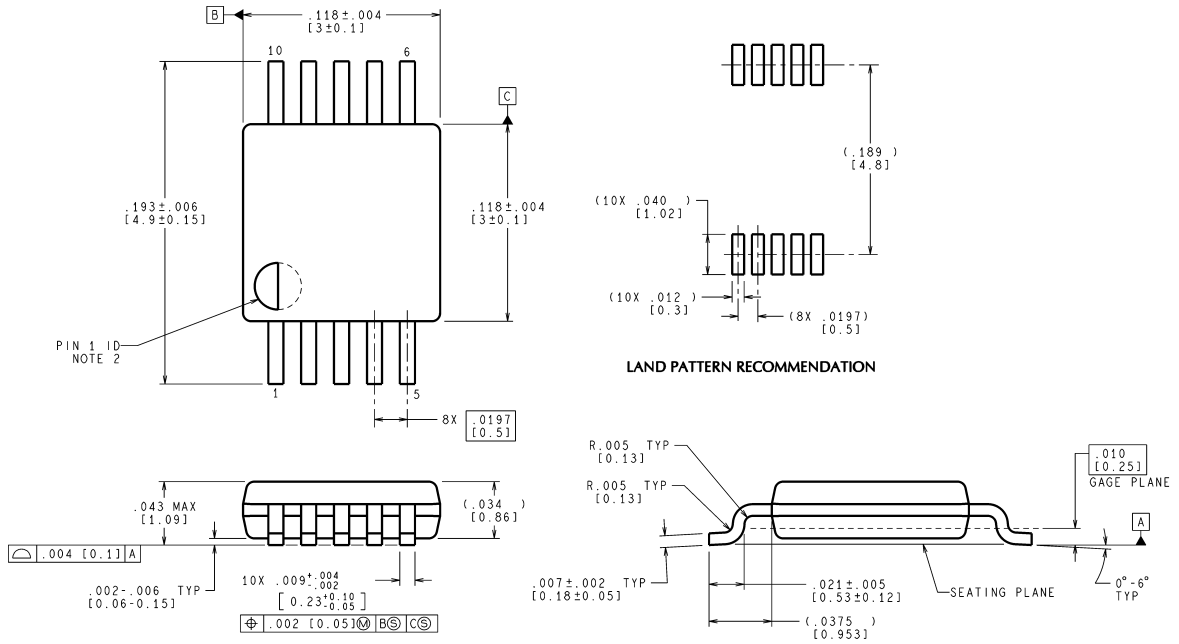

**CONTROLLING DIMENSION IS INCH**  
**VALUES IN [ ] ARE MILLIMETERS**  
 DIMENSIONS IN ( ) FOR REFERENCE ONLY

**MSOP**  
**Order Number LM4879MM**  
**NS Package Number MUB10A**



## Notes

National does not assume any responsibility for use of any circuitry described, no circuit patent licenses are implied and National reserves the right at any time without notice to change said circuitry and specifications.

For the most current product information visit us at [www.national.com](http://www.national.com).

### LIFE SUPPORT POLICY

NATIONAL'S PRODUCTS ARE NOT AUTHORIZED FOR USE AS CRITICAL COMPONENTS IN LIFE SUPPORT DEVICES OR SYSTEMS WITHOUT THE EXPRESS WRITTEN APPROVAL OF THE PRESIDENT AND GENERAL COUNSEL OF NATIONAL SEMICONDUCTOR CORPORATION. As used herein:

1. Life support devices or systems are devices or systems which, (a) are intended for surgical implant into the body, or (b) support or sustain life, and whose failure to perform when properly used in accordance with instructions for use provided in the labeling, can be reasonably expected to result in a significant injury to the user.
2. A critical component is any component of a life support device or system whose failure to perform can be reasonably expected to cause the failure of the life support device or system, or to affect its safety or effectiveness.

### BANNED SUBSTANCE COMPLIANCE

National Semiconductor certifies that the products and packing materials meet the provisions of the Customer Products Stewardship Specification (CSP-9-111C2) and the Banned Substances and Materials of Interest Specification (CSP-9-111S2) and contain no "Banned Substances" as defined in CSP-9-111S2.



**National Semiconductor**  
Americas Customer  
Support Center  
Email: [new.feedback@nsc.com](mailto:new.feedback@nsc.com)  
Tel: 1-800-272-9959

**National Semiconductor**  
Europe Customer Support Center  
Fax: +49 (0) 180-530 85 86  
Email: [europe.support@nsc.com](mailto:europe.support@nsc.com)  
Deutsch Tel: +49 (0) 69 9508 6208  
English Tel: +44 (0) 870 24 0 2171  
Français Tel: +33 (0) 1 41 91 8790

**National Semiconductor**  
Asia Pacific Customer  
Support Center  
Email: [ap.support@nsc.com](mailto:ap.support@nsc.com)

**National Semiconductor**  
Japan Customer Support Center  
Fax: 81-3-5639-7507  
Email: [jpn.feedback@nsc.com](mailto:jpn.feedback@nsc.com)  
Tel: 81-3-5639-7560

[www.national.com](http://www.national.com)