



User Guide for
FEBFSEZ1317A_CH310v3
Evaluation Board

Primary-Side-Regulation PWM Controller
FSEZ1317AMY
5.0V/0.7A Mobile Phone Battery Charger

Featured Fairchild Product:
FSEZ1317A

***Direct questions or comments
about this Evaluation Board to:
“Worldwide Direct Support”***

Fairchild Semiconductor.com

Table of Contents

1. Introduction.....	3
2. General Specifications	3
3. Functional Test Report.....	3
3.1. Input Current.....	4
3.2. Input Power at No-Load Condition.....	4
3.3. Line Regulation and Load Regulation	7
3.4. Efficiency	7
3.5. Output Ripple and Noise.....	8
3.6. Step Response	9
3.7. Over-Power Protection.....	10
3.8. Hold-up Time.....	10
3.9. Measured Waveforms	11
3.10. Short-Circuit Protection	12
3.11. Brownout Test.....	13
3.12. V _{DD} Voltage Level	13
3.13. Voltage Stress on MOSFET & Rectifiers.....	17
3.14. Constant Voltage (CV) and Constant Current (CC) Curves.....	19
3.15. EMI Test (Output with 1.8M Cable Wire).....	20
3.16. Surge test.....	22
3.17. ESD Test	22
4. Photographs.....	23
5. Circuit Schematic.....	24
6. PCB Layout.....	25
7. 76-B070063-00 FSEZ1317A Evaluation Board BOM.....	26
8. Specification Approval	27
9. Revision History	31

This user guide supports the evaluation board for the FSEZ1317A. It should be used in conjunction with the datasheet as well as Fairchild's application notes and technical support team. Please visit Fairchild's website at www.fairchildsemi.com.

1. Introduction

This document describes a 3.5W power supply using an FSEZ1317AMY device. This power supply is targeted for mobile phone battery chargers for a 30mW solution with high efficiency.

The controller used on the board is Fairchild Semiconductor's FSEZ1317AMY. This third-generation Primary-Side-Regulation (PSR) PWM controller with integrated MOSFET and improved EMI performance provides several features to enhance the performance of low-power flyback converters. The proprietary TRUECURRENT® technology enables precise Constant Current (CC) regulation and simplified circuit design for battery-charger applications. The result is a lower-cost, smaller, and lighter charger compared to conventional designs or a linear transformer. To minimize standby power consumption (30mW at 265V_{AC}), a proprietary Green Mode provides off-time modulation to linearly decrease PWM frequency under light-load conditions. Green Mode assists the power supply in meeting power conservation requirements. By using the FSEZ1317A, a charger can be implemented with few external components and minimized cost. A typical output CV/CC (Constant Voltage / Constant Current) characteristic envelope is shown in Figure 23 and Figure 24.

2. General Specifications

Specification	Min.	Max.	Units
Input			
Voltage	90	264	V _{AC}
Frequency	47	63	Hz
Output			
Output Voltage	4.75	5.25	V
Output Current	0	0.7	A
Total Output Power			
Full-Load Output Power	0	3.5	W

Note:

1. All results tested with output DC cable, AWG 26, 1.8M.

3. Functional Test Report

Test Model	FEBFSEZ1317A_CH310v3
Test Date	Dec.20, 2010
Test Temperature	Ambient
Test Equipment	AC Source: 6800 Series AC POWER SOURCE
	Electronic Load: Chroma 63030
	Power Meter: WT210
	Oscilloscope: TDS3014B

Test Items	<ol style="list-style-type: none"> 1. Input current 2. Input power at no-load condition 3. Startup time 4. DC output rising time 5. Line regulation and load regulation 6. Efficiency 7. Output ripple and noise 8. Step response 9. Over-current protection 10. Hold-up time 11. Short-circuit protection 12. Brownout test 13. V_{DD} voltage level 14. Voltage stress on MOSFET and rectifier 15. Constant voltage and constant current curve 16. EMI test 17. Surge Test 18. ESD test
-------------------	---

3.1. Input Current

3.1.1. Test Condition

Measure the AC input current at maximum load.

3.1.2. Test Result

Input Voltage	Input Current
90V / 60Hz	96.73mA
264V / 50Hz	49.14mA

3.2. Input Power at No-Load Condition

3.2.1. Test Condition

Measure the input power and output voltage at no-load condition.

3.2.2. Test Result

Input Voltage	Input Wattage (mW)	Output Voltage (V)
90V / 60Hz	21.84	5.055
115V / 60Hz	22.79	5.056
230V / 50Hz	25.8	5.075
264V / 50Hz	28.1	5.085

3.2.3. Measured Waveforms

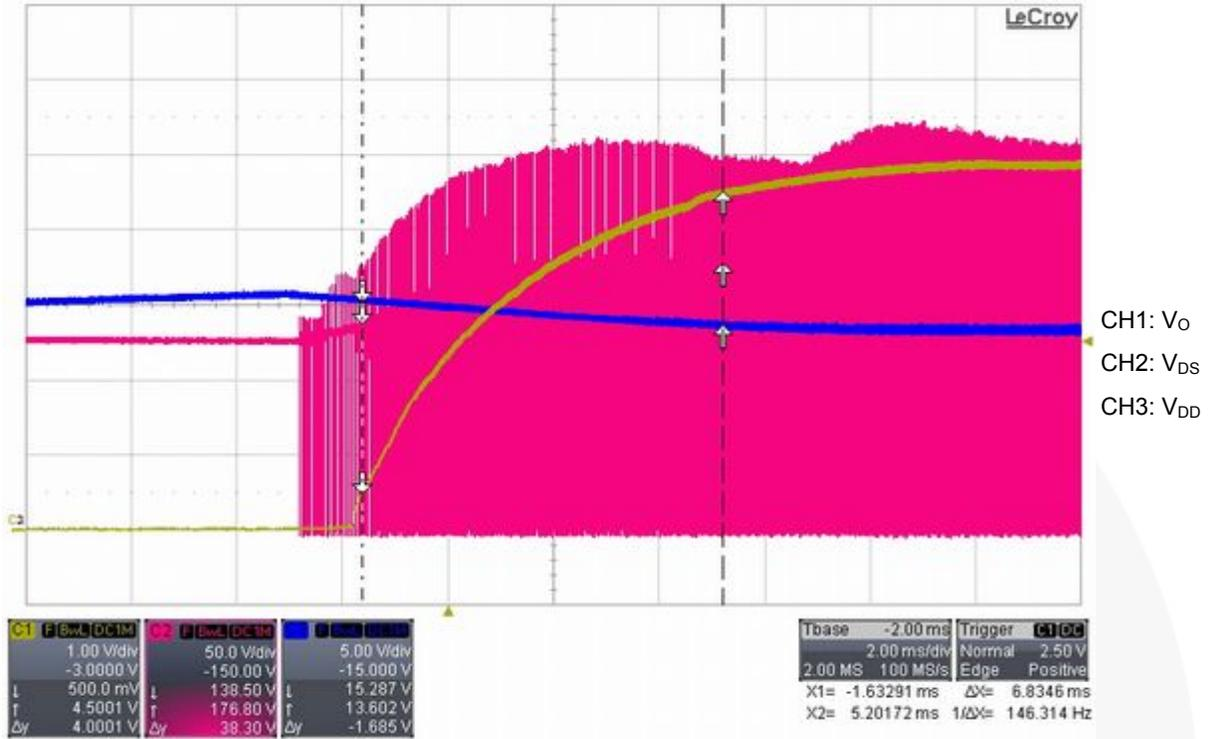

Figure 1. 90V/60Hz at Maximum Load

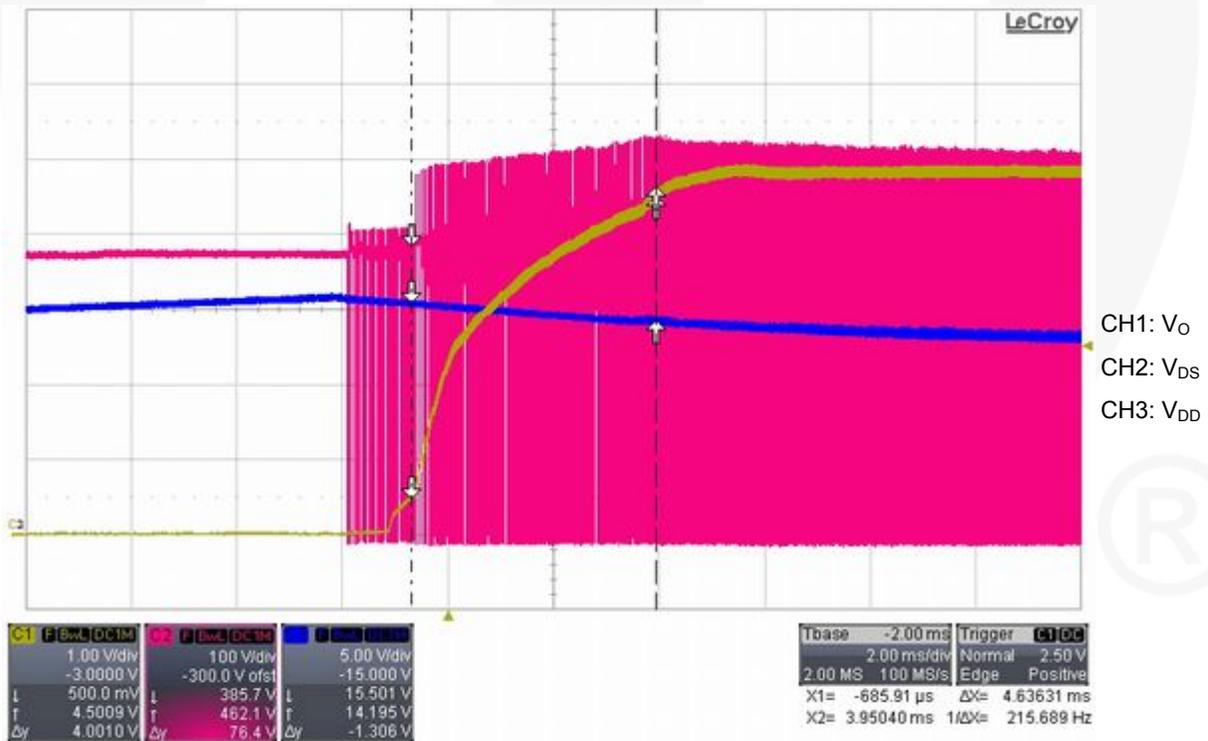

Figure 2. 264V/50Hz at Maximum Load

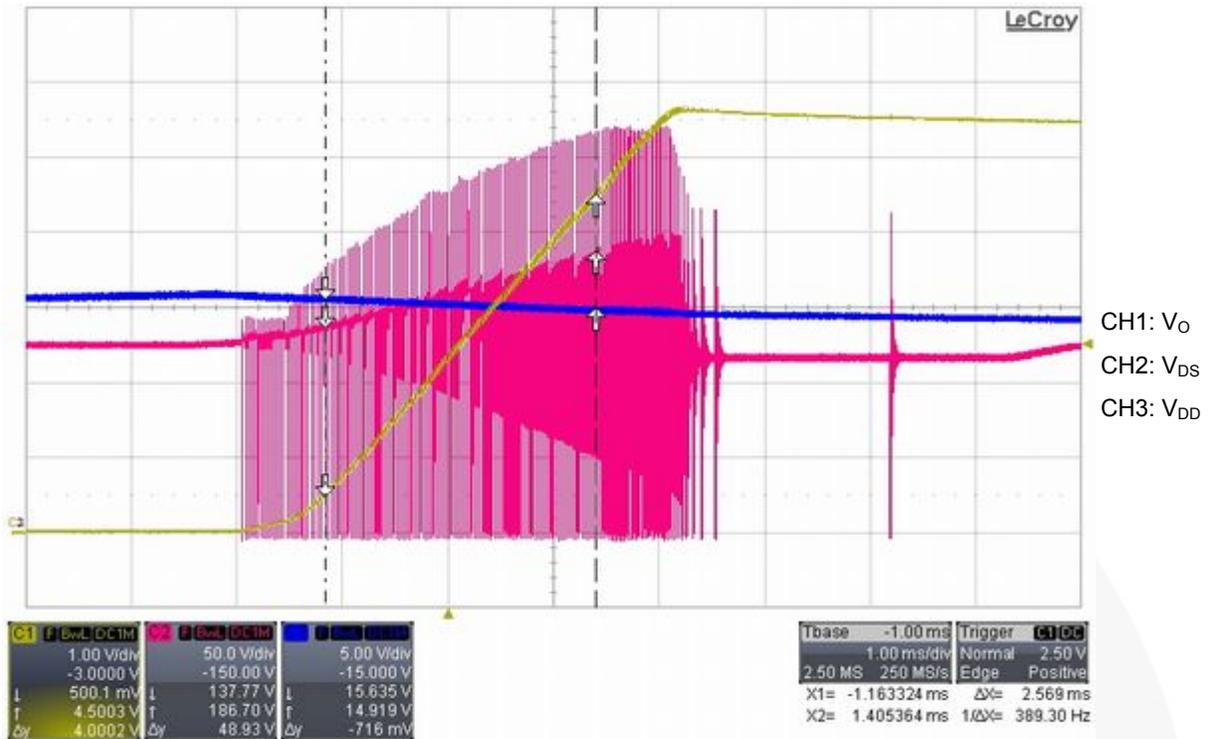

Figure 3. 90V/60Hz at No Load

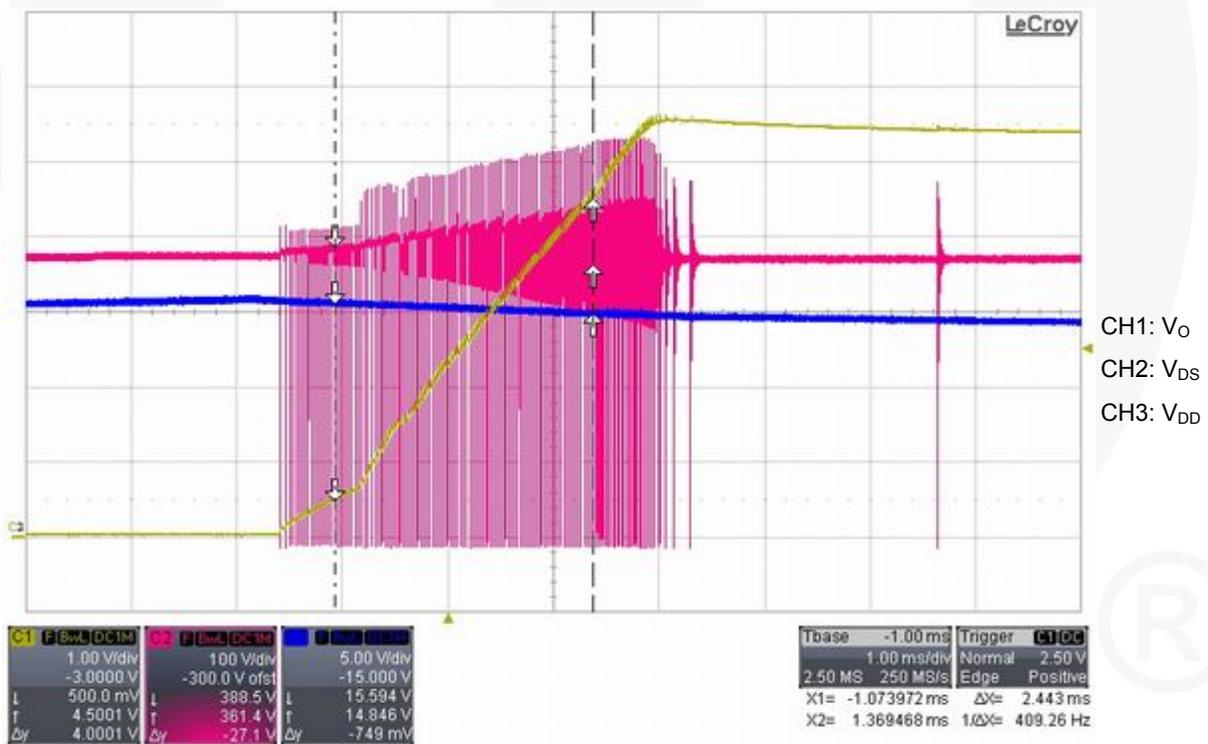

Figure 4. 264V/50Hz at No Load

3.3. Line Regulation and Load Regulation

3.3.1. Test Condition

Measure line regulation and load regulation according to below table of test results.

3.3.2. Test Result

Input Voltage	Output Voltage at Maximum Load (V)	Output Voltage at Minimum Load (V)	Load Regulation (%)	Specification
90V / 60Hz	5.032	5.055	0.23	±5%
115V / 60Hz	5.035	5.056	0.21	
230V / 50Hz	5.036	5.075	0.39	
264V / 50Hz	5.038	5.085	0.47	
Line Regulation(%)	0.06	0.3		

3.4. Efficiency

3.4.1. Test Condition

Measure input power and output power at maximum load.

3.4.2. Test Result

Input Voltage	Input Wattage (W)	Output Wattage (W)	Efficiency (%)
90V / 60Hz	5.061	3.518	69.50
115V / 60Hz	4.981	3.526	70.79
230V / 50Hz	4.979	3.537	71.03
264V / 50Hz	5.013	3.537	70.55

3.4.3. Test Result

Input Voltage	Efficiency(%)				
	25% Load	50% Load	75% Load	100% Load	Avg.
115V / 60Hz	71.24	72.58	72.02	70.79	71.66
230V / 50Hz	68.94	71.50	71.73	71.03	70.80

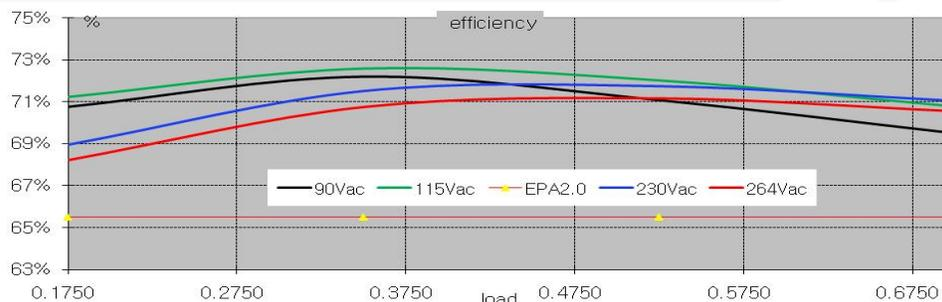

Figure 5. Efficiency

3.5. Output Ripple and Noise

3.5.1. Test Condition

Ripple and noise are measured by using a 20MHz bandwidth-limited oscilloscope with a 10 μ F capacitor paralleled with a high-frequency 0.1 μ F capacitor across each output.

3.5.2. Test Result

Input Voltage	Maximum Load (mV)	Minimum Load (mV)	Specification
90V / 60Hz	136	40	200mV
115V / 60Hz	134	32	
230V / 50Hz	146	35	
264V / 50Hz	154	40	

3.5.3. Measured Waveforms

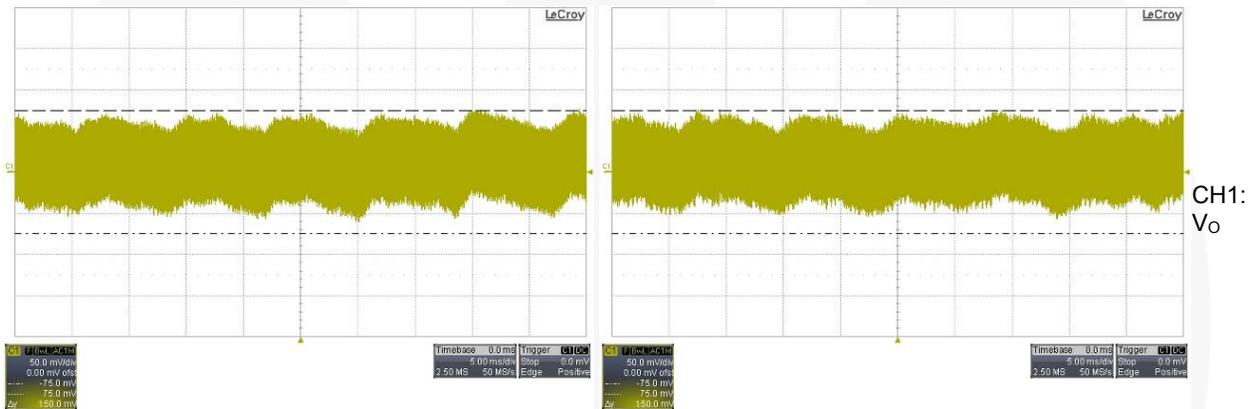

Figure 6. 90V/60Hz and 115V/60Hz at Maximum Load



Figure 7. 230V/50Hz and 264V/50Hz at Maximum Load

3.6. Step Response

3.6.1. Test Condition

Dynamic loading (20%~80% of the full load, 5ms duty cycle, 2.5 A/ μ s rise/fall time).

3.6.2. Test Result

Input Voltage	Overshoot (mV)	Undershoot (mV)
115V / 60Hz	300	310
230V / 50Hz	320	320

3.6.3. Measured Waveforms

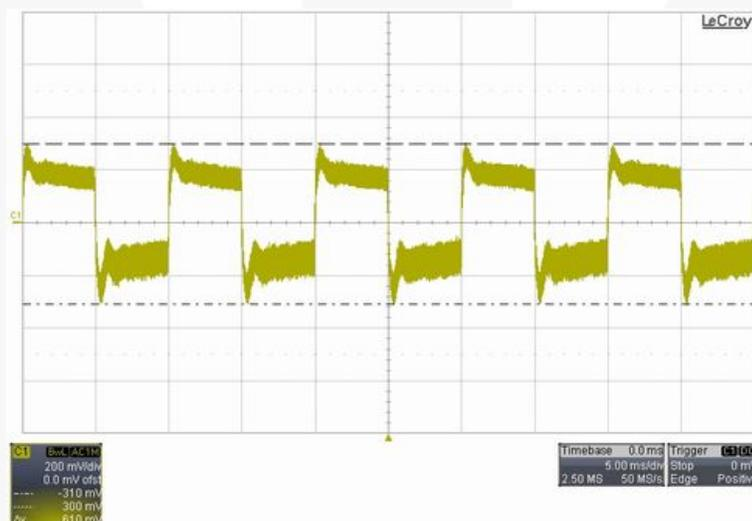

Figure 8. 115V/60Hz at Maximum Load

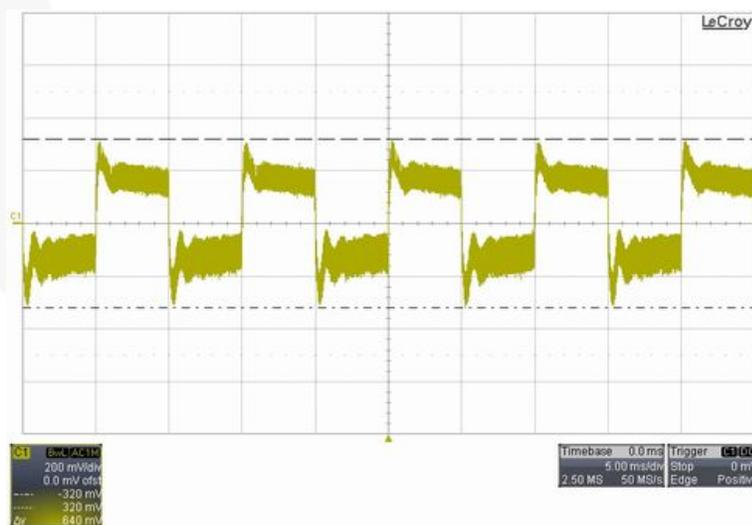

Figure 9. 230V/50Hz at Maximum Load



3.7. Over-Power Protection

3.7.1. Test Condition

Increase output loading gradually. Measure the output maximum power.

3.7.2. Test Result

Input Voltage	Output Power(W)
90V / 60Hz	3.80
115V / 60Hz	3.83
230V / 50Hz	3.90
264V / 50Hz	3.93

3.8. Hold-up Time

3.8.1. Test Condition

Set output at maximum load. Measure the time interval between AC off and output voltage falling to lower limit of rated value. The AC waveform should be off at zero degrees.

3.8.2. Test Result

Input Voltage	Hold-up Time (ms)
90V / 60Hz	11.32
115V / 60Hz	20.71
230V / 50Hz	102.00
264V / 50Hz	136.50

3.9. Measured Waveforms

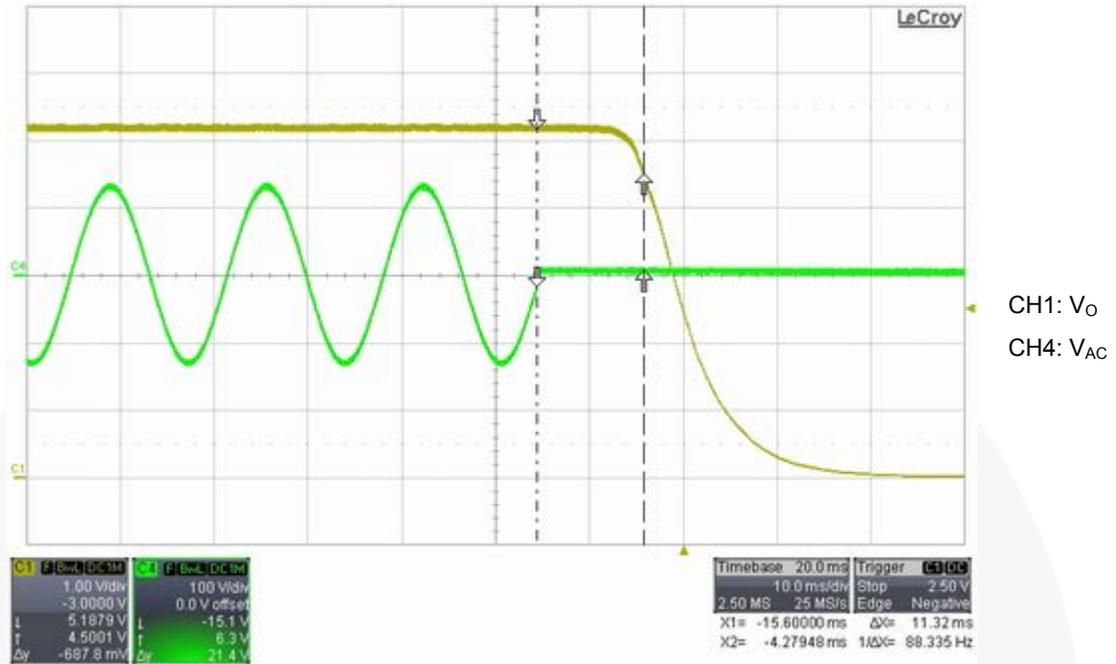

Figure 10. 90V/60Hz at Maximum Load

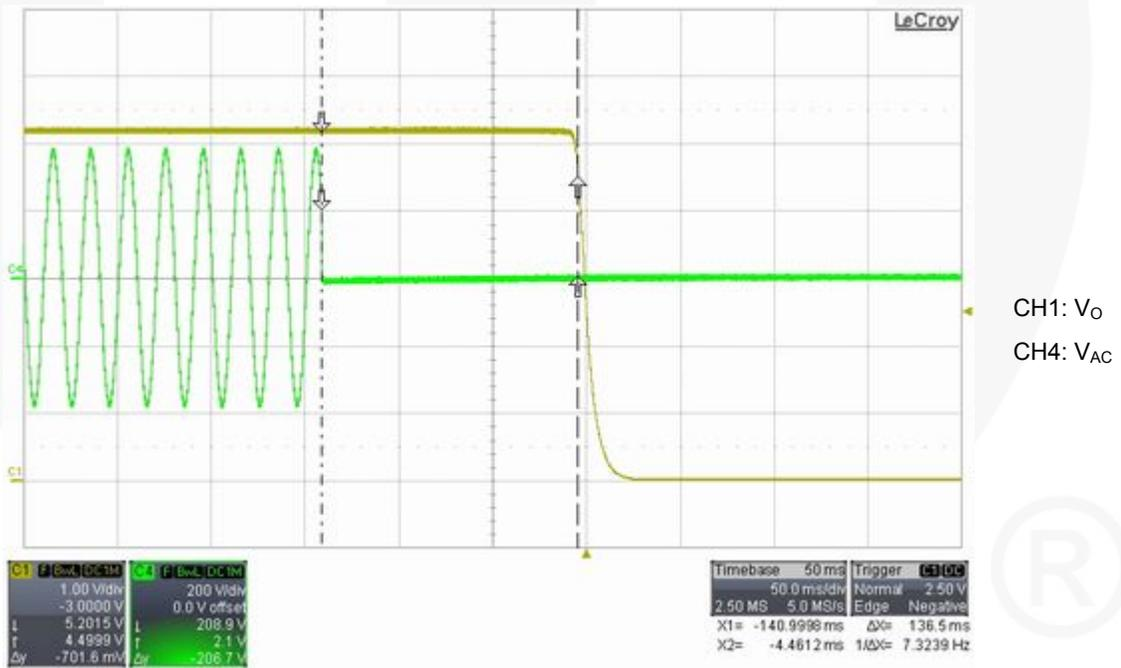

Figure 11. 264V/50Hz at Maximum Load

3.10. Short-Circuit Protection

3.10.1. Test Condition

Short the output of the power supply. The power supply should enter “Hiccup” Mode protection with less than 2W input voltage.

3.10.2. Test Result

Input Voltage	Input Wattage at Maximum Load (W)	Input Wattage at Minimum Load (W)
90V / 60Hz	0.2770	0.2825
264V / 50Hz	0.8230	0.8460

3.10.3. Measured Waveforms

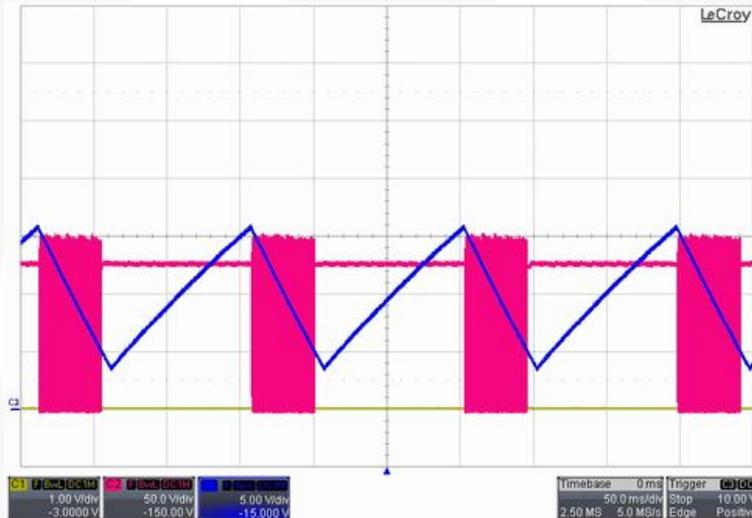

CH1: V_o
CH2: V_{DS}
CH3: V_{DD}

Figure 12. 90V/60Hz at Maximum Load

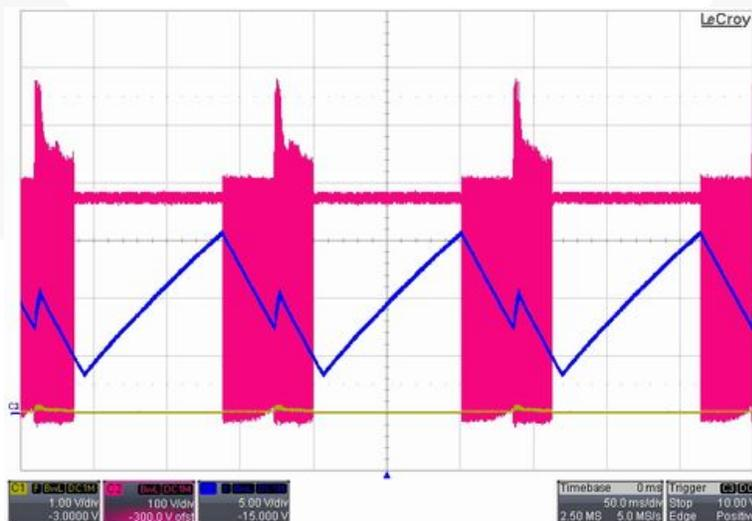

CH1: V_o
CH2: V_{DS}
CH3: V_{DD}

Figure 13. 264V/50Hz at Maximum Load



3.11. Brownout Test

3.11.1. Test Condition

Set output at maximum loading. Decrease input voltage with 5V_{AC} step. Record input wattage and output voltage. After the output is off, increase the AC voltage gradually and record the recovery voltage.

3.11.2. Test Result

Input Voltage	Input Wattage (W)	Output Voltage(V)
90V / 60Hz	5.136	5.186
85V / 60Hz	5.169	5.186
80V / 60Hz	5.198	5.182
75V / 60Hz	5.236	5.176
70V / 60Hz	5.281	5.162
Recovery Input Voltage		
70V / 60Hz	5.280	5.162

3.12. V_{DD} Voltage Level

3.12.1. Test Result

	Min. Load (V)	Max. Load (V)	Near OPP (V)	Output Short Circuit (V)
90V / 60Hz	7.7	13.6	13.7	16.0
264V / 50Hz	7.4	13.5	13.5	15.8

1.1 Measured Waveforms

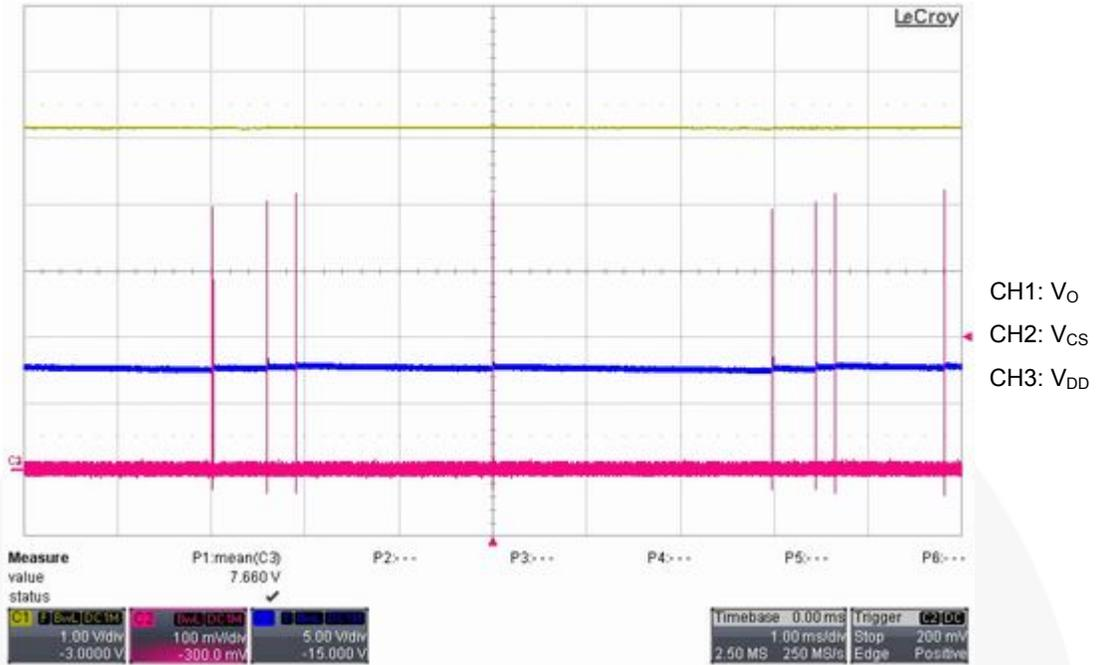

Figure 14. 90V/60Hz at No Load

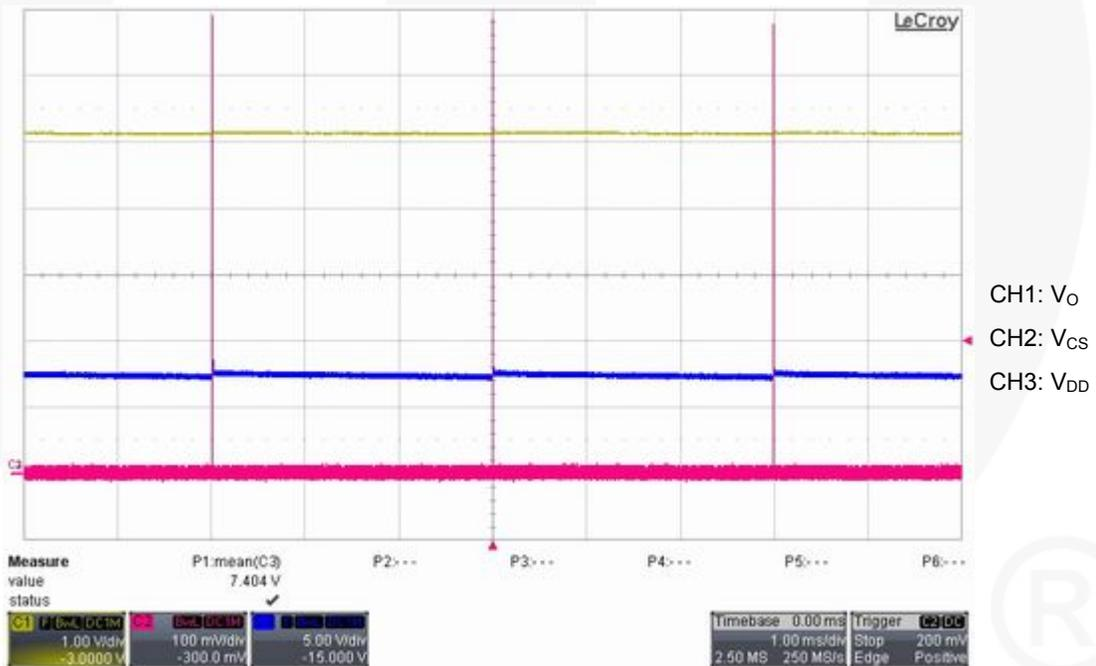

Figure 15. 264V/50Hz at No Load

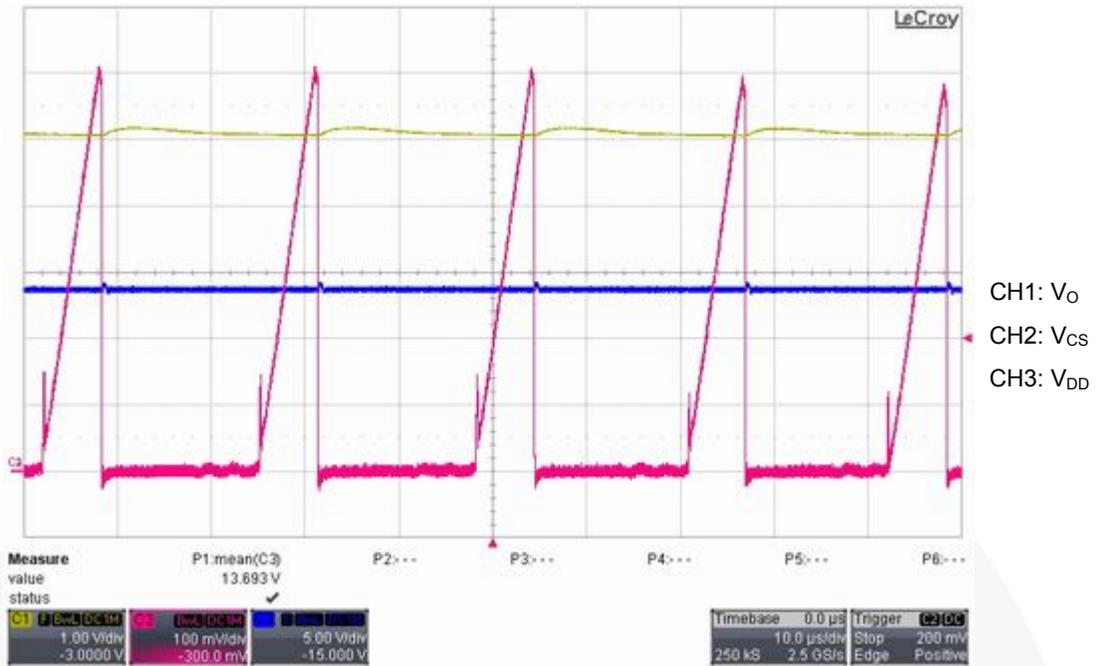

Figure 16. 90V/60Hz at Over-Power Protection

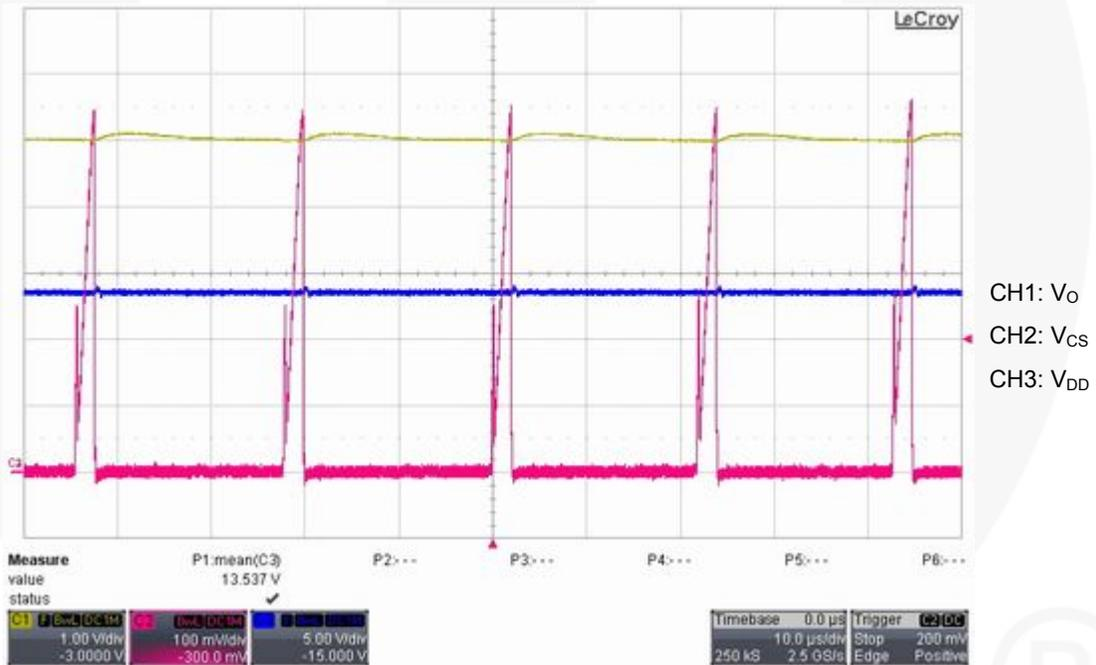
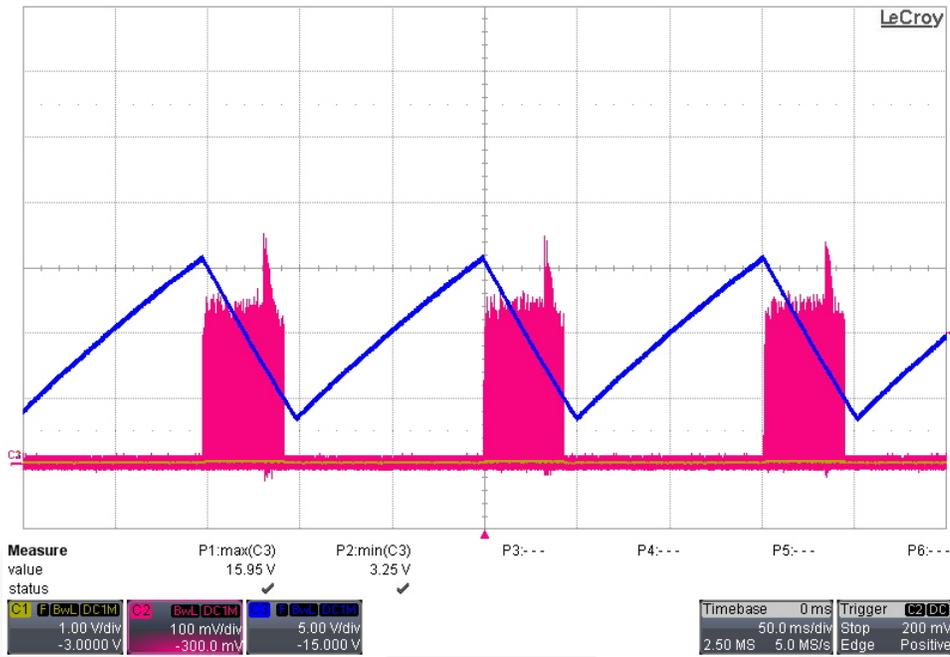
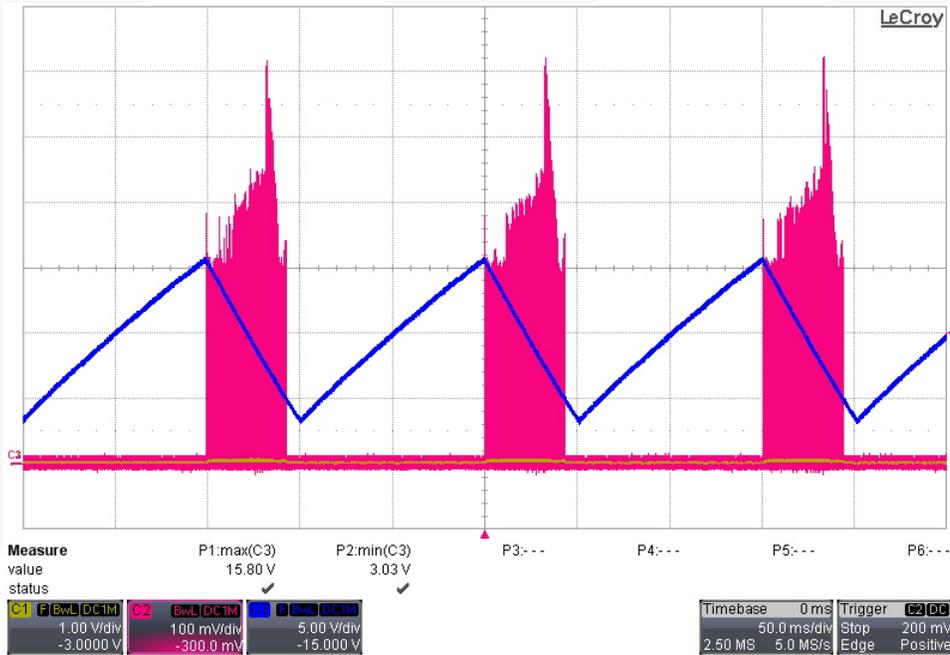

Figure 17. 264V/50Hz at Over-Power Protection



CH1: V_O
CH2: V_{CS}
CH3: V_{DD}

Figure 18. 90V/60Hz at Output Short



CH1: V_O
CH2: V_{CS}
CH3: V_{DD}

Figure 19. 264V/50Hz at Output Short

3.13. Voltage Stress on MOSFET & Rectifiers

3.13.1. Test Condition

Measure the voltage stress on MOSFET and secondary rectifiers under conditions specified below.

3.13.2. Test Result

	Stress on MOSFET	Rating	Stress on Rectifier	Rating
90V / 60Hz, Max. Load	287	700V	16.0	40V
90V / 60Hz, Max. Load, Startup	284		16.0	
90V / 60Hz, Max. Load, Output Short	182		11.0	
264V / 50Hz, Max. Load	549		36.8	
264V / 50Hz, Max. Load, Startup	542		36.2	
264V / 50Hz, Max. Load, Output Short	606		32.3	
264V / 50Hz, Max. Load Turns Off	549		36.8	

3.13.3. Measured Waveforms

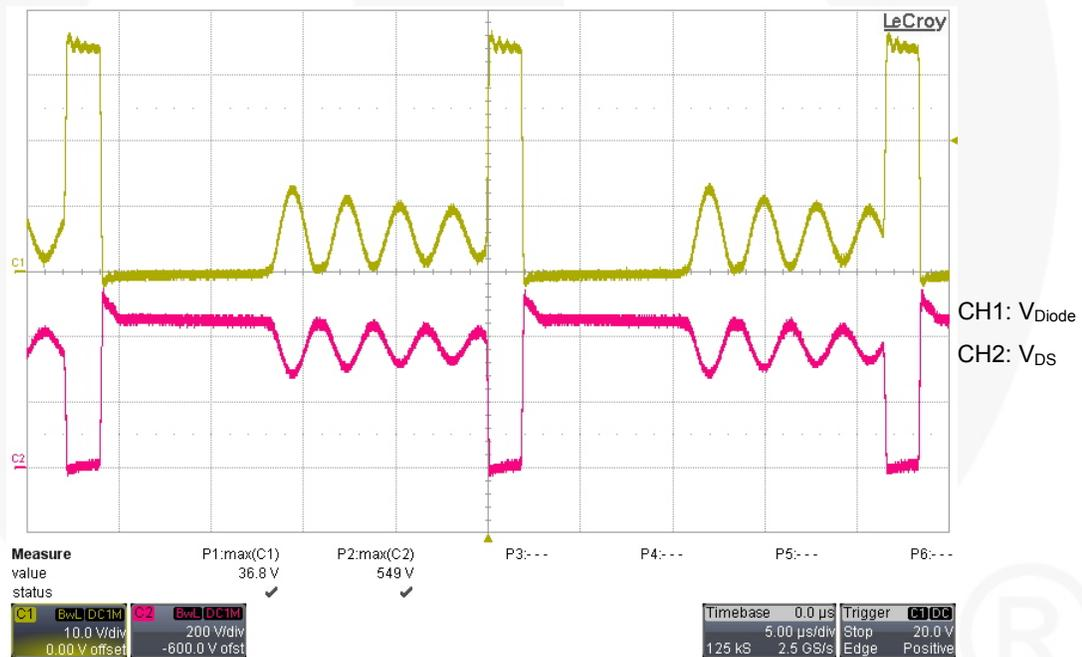

Figure 20. 264V/50Hz at Maximum Load

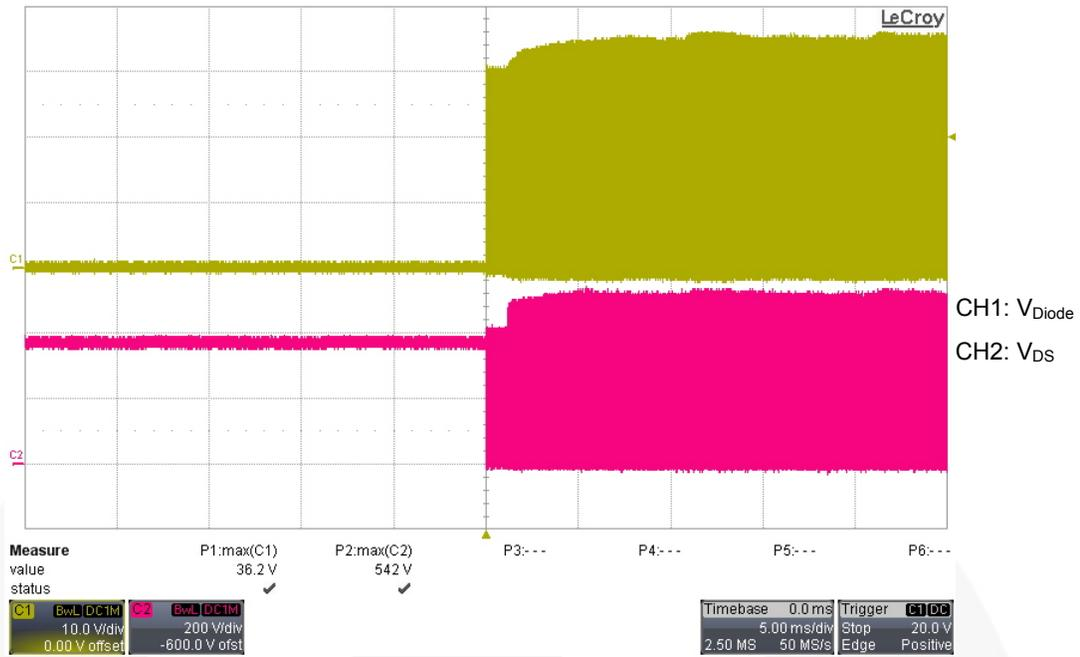

Figure 21. 264V/50Hz at Maximum Load Startup

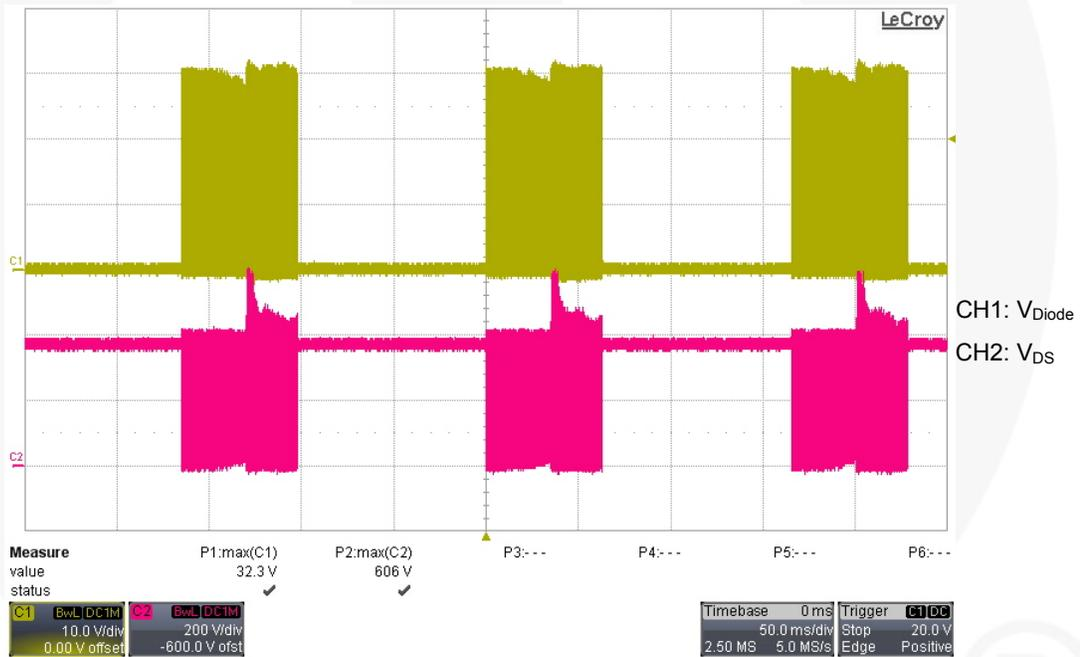

Figure 22. 264V/50Hz at Maximum Load Short

3.14. Constant Voltage (CV) and Constant Current (CC) Curves

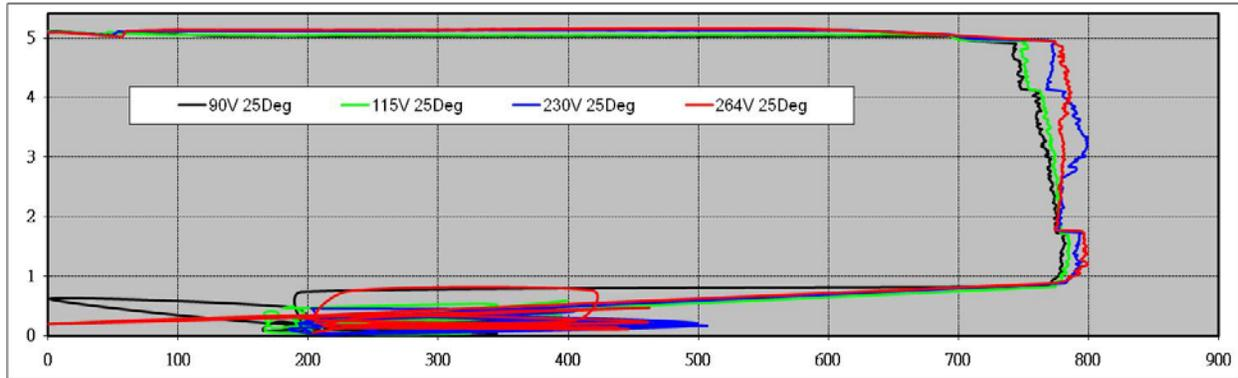

Figure 23. Constant Current Curve

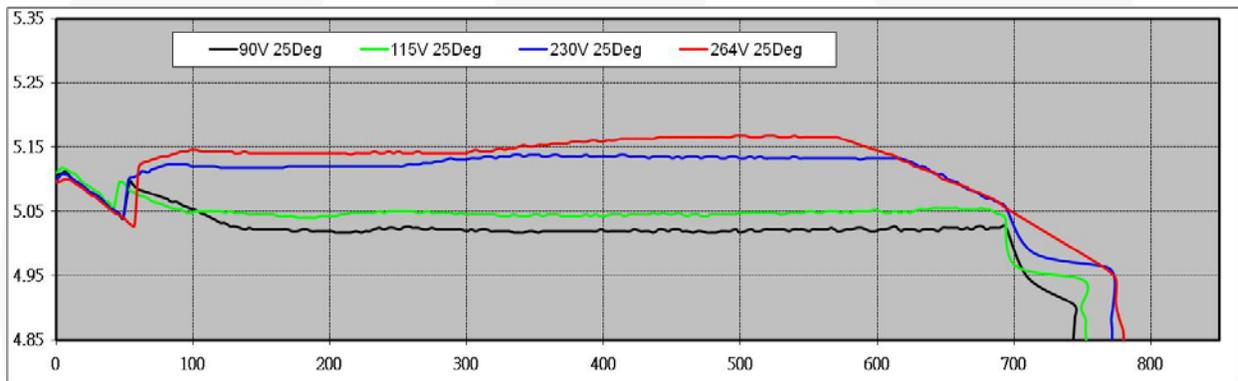

Figure 24. Constant Voltage Curve

3.15. EMI Test (Output with 1.8M Cable Wire)

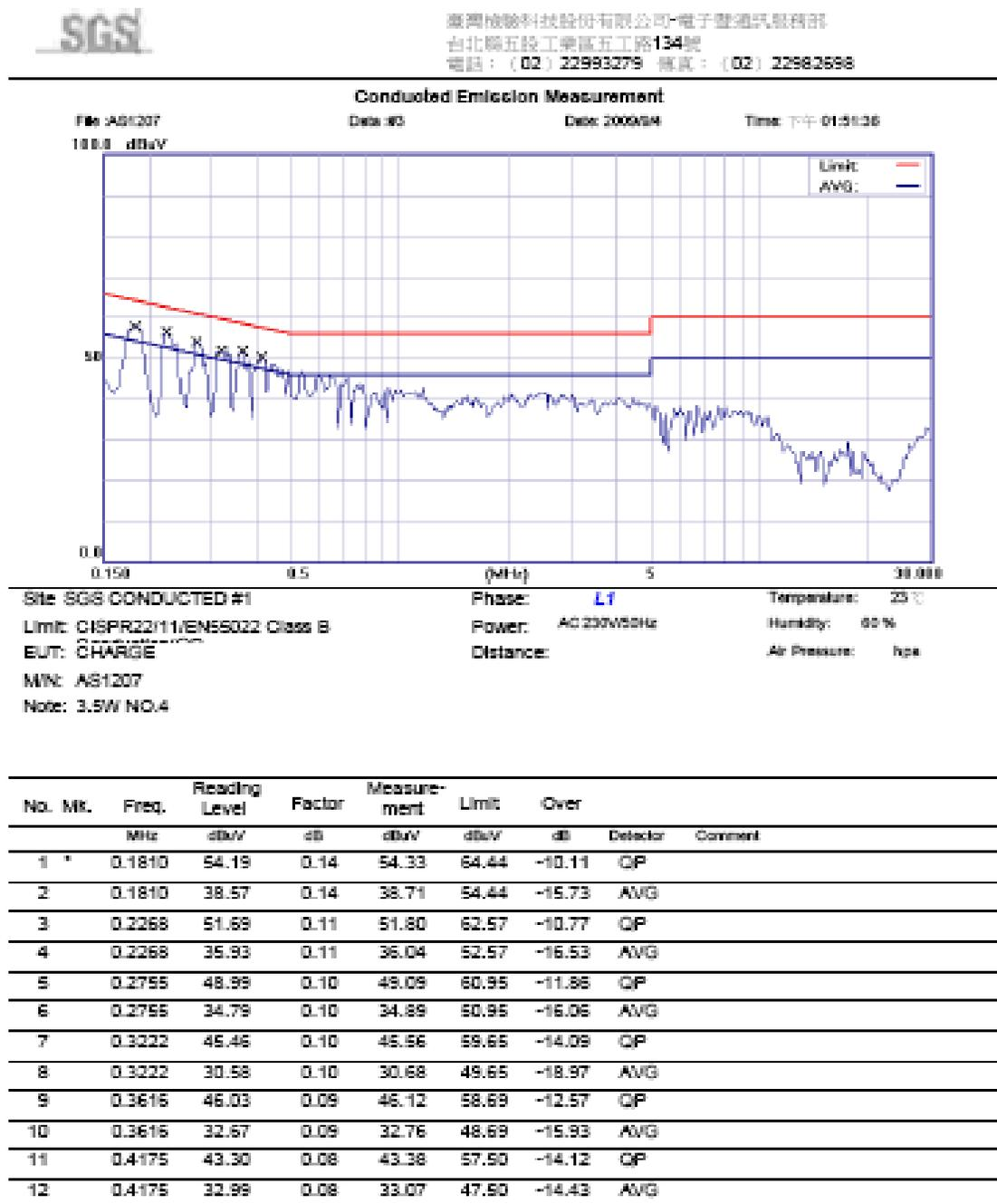
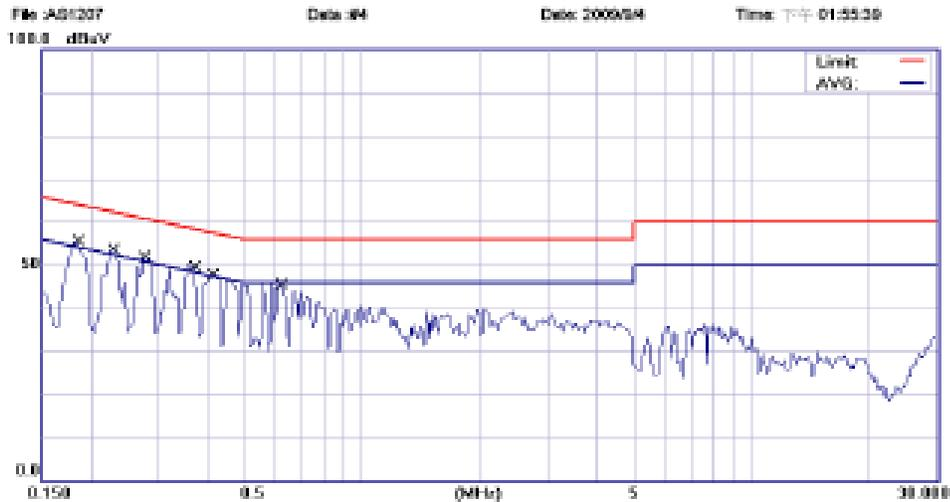

Figure 25. Conduction-Line at 230V_{AC}



臺灣檢驗科技股份有限公司-電子暨通訊服務部
台北縣五股工業區五工路134號
電話：(02) 22993279 傳真：(02) 22983598

Conducted Emission Measurement



Site: SGS CONDUCTED #1 Phase: *N* Temperature: 23 °C
 Limit: CISPR22/11/EN55022 Class B Power: AC 230V50Hz Humidity: 60 %
 EUT: CHARGE Distance: Air Pressure: hpa
 MW: AS1207
 Note: 3.5W NO.4

No.	Mk.	Freq. MHz	Reading		Measure- ment dBuV	Limit dBuV	Over dB	Detector	Comment
			Level dBuV	Factor dB					
1	*	0.1856	51.68	0.16	51.84	64.23	-12.39	QP	
2		0.1856	34.45	0.16	34.61	54.23	-19.62	AVG	
3		0.2288	49.88	0.14	50.02	62.49	-12.47	QP	
4		0.2288	32.66	0.14	32.80	62.49	-19.69	AVG	
5		0.2777	46.55	0.13	46.68	60.88	-14.20	QP	
6		0.2777	28.74	0.13	28.87	60.88	-22.01	AVG	
7		0.3668	44.19	0.11	44.30	58.57	-14.27	QP	
8		0.3668	27.88	0.11	27.99	48.57	-20.58	AVG	
9		0.4138	41.17	0.11	41.28	57.57	-16.29	QP	
10		0.4138	27.50	0.11	27.61	47.57	-19.96	AVG	
11		0.6199	38.27	0.10	38.37	56.00	-17.63	QP	
12		0.6199	18.72	0.10	18.82	46.00	-27.18	AVG	

Figure 26. Conduction- Neutral at 230V_{AC}

3.16. Surge test

3.16.1. Test Condition

- Maximum Load, $V_{IN} (AC) = 230V 50Hz$
- L-PE: (Positive & Negative) 1KV~4.4KV
- N-PE: (Positive & Negative) 1KV~4.4KV
- L-N: (Positive & Negative) 500V~1KV

3.16.2. Test Result

Mode	Polarity	Phase	Voltage	Condition
L-PE	+/-	0°	4.4KV	Pass
	+/-	90°		Pass
	+/-	180°		Pass
	+/-	270°		Pass
N-PE	+/-	0°	4.4KV	Pass
	+/-	90°		Pass
	+/-	180°		Pass
	+/-	270°		Pass
L-N	+/-	0°	2.0KV	Pass
	+/-	90°		Pass
	+/-	180°		Pass
	+/-	270°		Pass

3.17. ESD Test

3.17.1. Test Condition

- Maximum Load, $V_{IN} (AC) = 230V 50Hz$
- Air: (Positive & Negative) 8KV~16KV
- Contact: (Positive & Negative) 4KV~8KV

3.17.2. Test Result

Mode	Polarity	Voltage	Condition
Air	+/-	16.5KV	Pass
Contact	+/-	8.8KV	Pass

4. Photographs

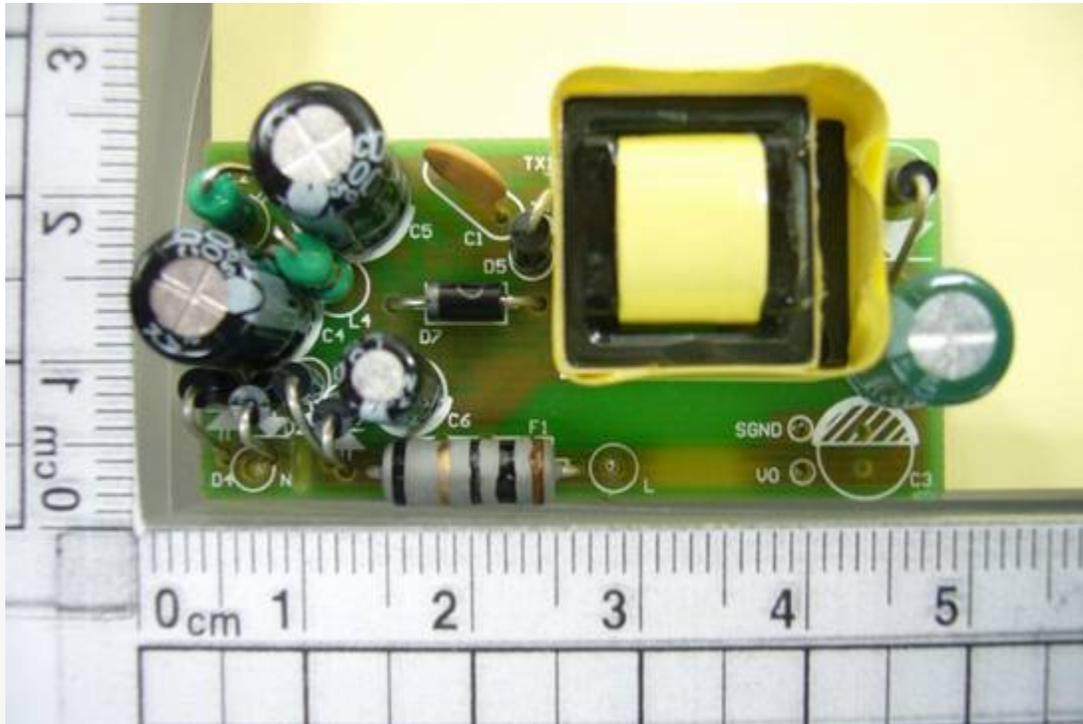

Figure 27. Vertical View

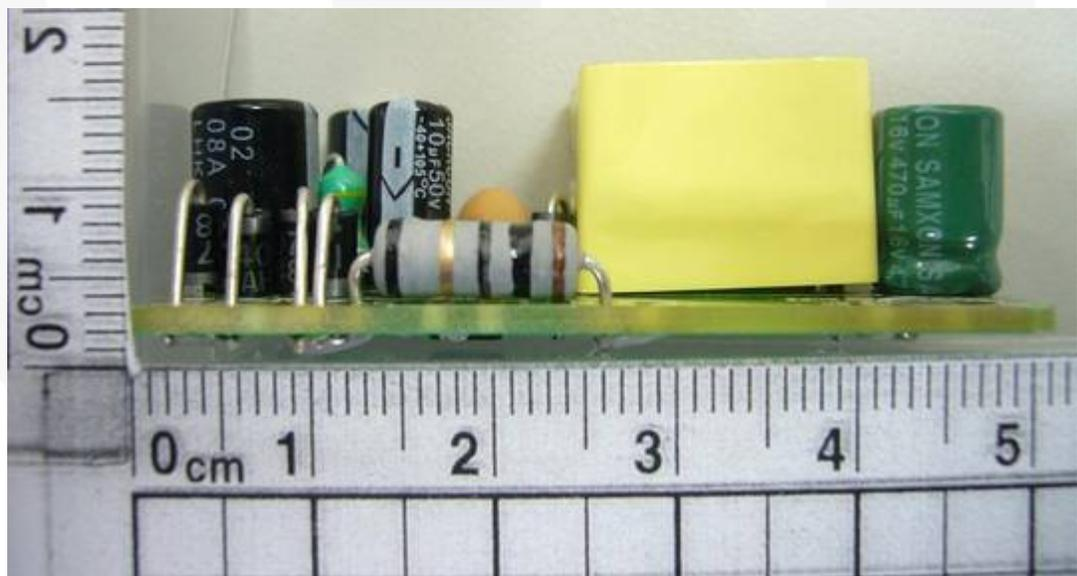

Figure 28. Lateral View

5. Circuit Schematic

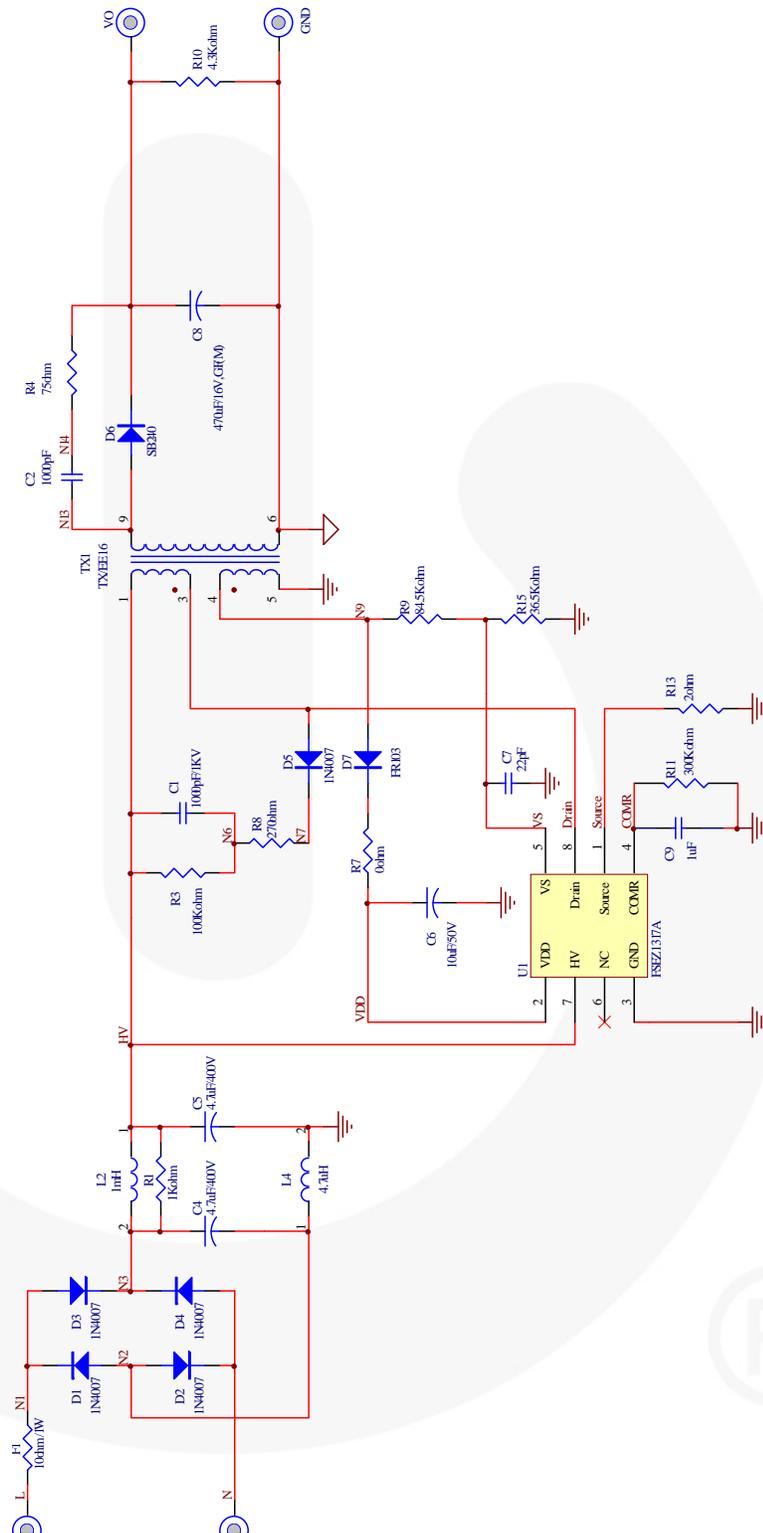
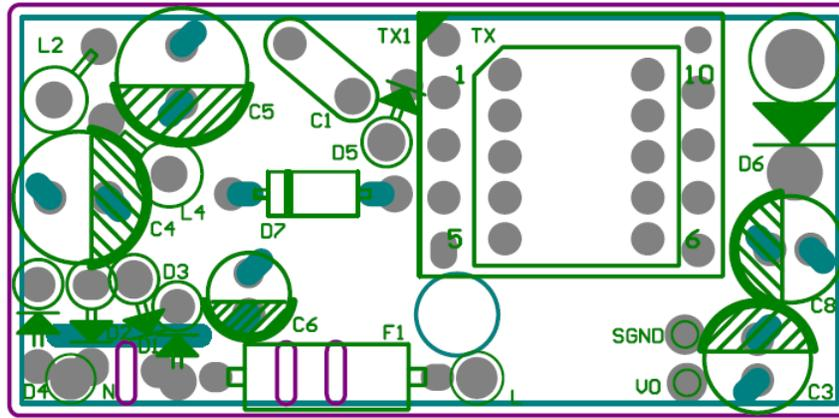

Figure 29. Circuit Schematic

6. PCB Layout



Top Overlay

Figure 30. Top Overlay

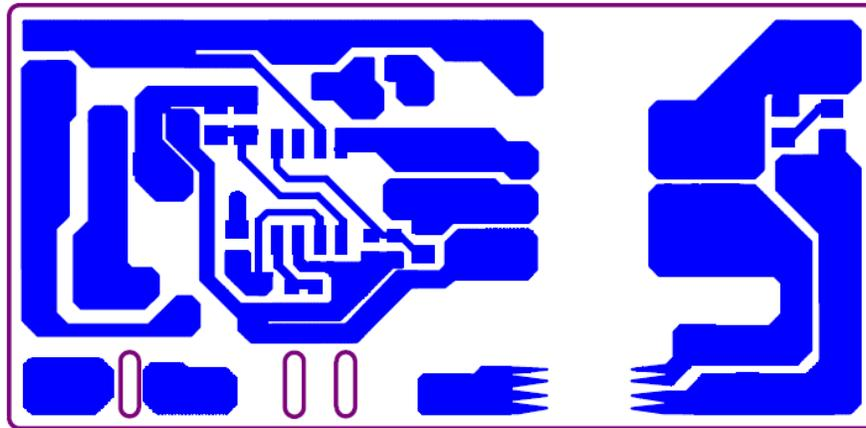

Bottom Layer

Figure 31. Bottom Layer

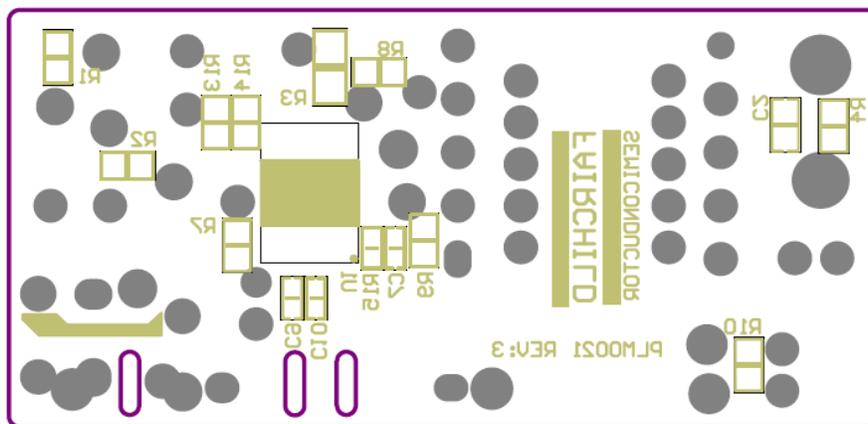

Bottom Overlay

Figure 32. Bottom Overlay

7. 76-B070063-00 FSEZ1317A Evaluation Board BOM

Component	Qty	Part No.	Manufacturer	Reference
Wire Wound Resistor 1W 10Ω±5%	1	KNP1W10ΩJP	TZAI YUAN	F1
Chip Resistor 0603 36.5KΩ±1%	1			R15
Chip Resistor 0603 300KΩ±1%	1			R11
Chip Resistor 0805 0Ω±5%	1			R7
Chip Resistor 0805 2Ω ±1%	1			R13
Chip Resistor 0805 75Ω±5%	1			R4
Chip Resistor 0805 270Ω±5%	1			R8
Chip Resistor 0805 1KΩ±5%	1			R1
Chip Resistor 0805 4.3KΩ±5%	1			R10
Chip Resistor 0805 84.5KΩ±1%	1			R9
Chip Resistor 1206 100KΩ±5%	1			R3
MLCC 0603 NPO 22P 50V±5%	1			C7
MLCC 0603 X7R 1μF 25±10%	1			C9
MLCC 0805 X7R 1000P 50V±10%	1			C2
Ceramic Capacitor 1000P 1KV+80/-20%	1			C1
Electrolytic Capacitor 4μ7 400V 105°C	2		JACKCON	C4 C5
Electrolytic Capacitor 10μ 50V 105°C	1		JACKCON	C6
Electrolytic Capacitor 470μ 16V/105°C	1	EGF477M1CF12TV	SAMXON	C8
Fixed Inductor 1mH±10%	1	EC36-102K	SYNTON	L2
Fixed Inductor 4.7μH±10%	1	EC36-4R7K	SYNTON	L4
Transformer EE-16-H 2.25mH	1	TRN0272	SEN HUEI	TX1
Fast Diode DO-41 1A/200V	1	FR103	CP	D7
Diode DO-41 1A/200V	5	1N4007		D1 D2 D3 D4 D5
Schottky Diode DO-15 2A/40V	1	SB240	CP	D6
1.0A/700V PSR IC	1	FSEZ1317AMY_F116	Fairchild	U1
PCB PLM0021 REV 3	1			

8. Specification Approval

Customer	SYSTEM GENERAL CORP.			P/N:	TRN-0272
DATE	08/24/2009	Version	A	Page	1/4

尺寸图：

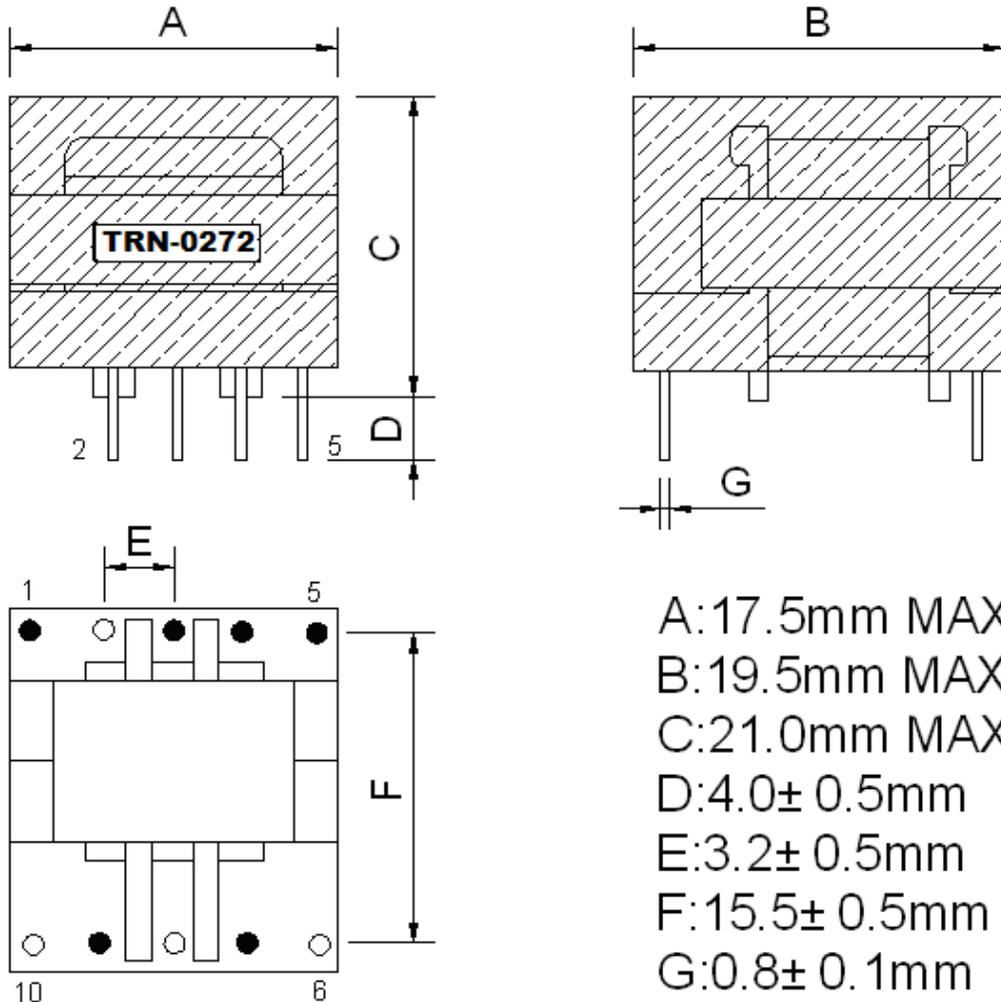

1.Pin2,6,8,10.removed

2.copper shield:0.025x7mm,lead to pin 1

3.Transformer outside need use 14mm insulation tape 4turns

UNIT	m/m	DRAWN	CHECK	TITLE	TRANS
TEL	(02)29450588	Ci wun Chen	Guo long Huang	IDENT NO.	TRN-0272
FAX	(02)2215-8293	SEN HUEI INDUSTRIAL CO.,LTD.		DWG NO.	
No.26-1, Lane 128, Sec. 2, Singnan Rd., Jhonghe City, Taipei County 235, Taiwan (R.O.C.)					

Customer	SYSTEM GENERAL CORP.			P/N:	TRN-0272
DATE	08/24/2009	Version	A	Page	2/4

2.SCHEMATIC :

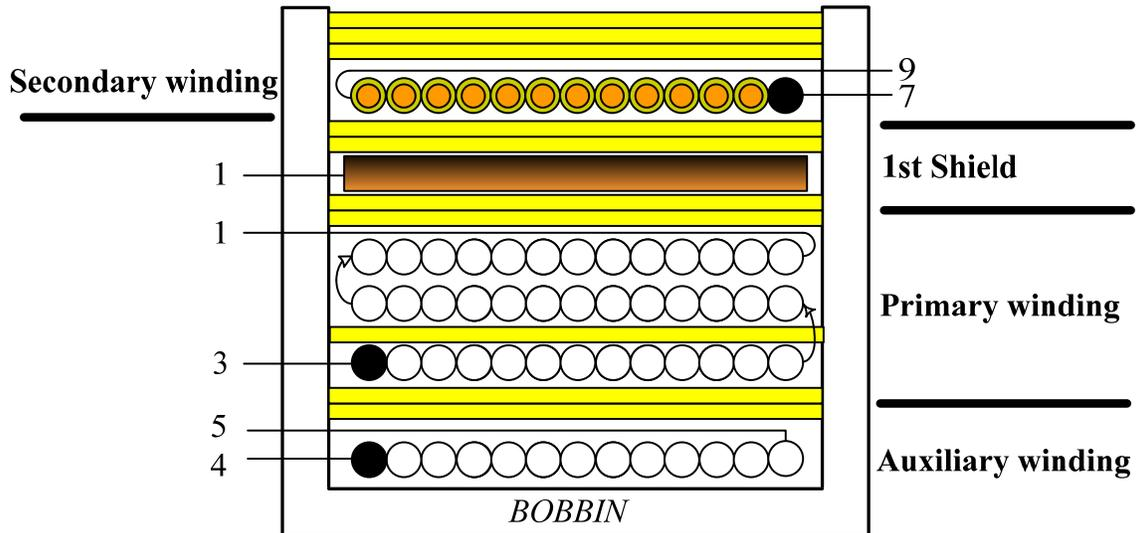

- ** W4R's winding is reversed winding.
- ** When W4R winding, need to add tube at beginning and terminal.
- ** When W4 is winding, it must wind one layer.
- ** When W2 is winding, put one layer tape after winding first layer.

NO	TERMINAL		WIRE	Ts	INSULATION		BARRIER	
	S	F			Ts	pri	sec	
W1	4	5	2UEW 0.23*2	15	2	-	-	
W2	3	1	2UEW 0.17*1	40	1	-	-	
				40	0			
				37	2			
W3	1	-	COPPER SHIELD	1.2	2	-	-	
W4R	7	9	TEX-E 0.55*1	9	2	-	-	
			CORE ROUNDING TAPE		3			

UNIT	m/m	DRAWN	CHECK	TITLE	TRANS
TEL	(02)2215-8302	Ci wun Chen	Guo long Huang	IDENT NO.	TRN-0272
FAX	(02)2215-8293	SEN HUEI INDUSTRIAL CO.,LTD.		DWG NO.	
No.26-1, Lane 128, Sec. 2, Singnan Rd., Jhonghe City, Taipei County 235, Taiwan (R.O.C.)					

Customer		SYSTEM GENERAL CORP.		P/N:	TRN-0272
DATE	08/24/2009	Version	A	Page	3/4
<p>3.ELECTRICAL SPECIFICATION :</p> <p>3.1 Inductance test : at 1KHz ,1V</p> <p>P(3-1) : 2.25mH ±7% (2.1mH Min. ~ 2.4mH Max.)</p> <p>3.2 Hi-pot test :</p> <p>AC 3.0K V /60Hz/5mA hi-pot for one minute between pri to sec. AC 1.5K V /60Hz/5mA hi-pot for one minute between pri to core. AC 1.5K V /60Hz/5mA hi-pot for one minute between sec to core.</p> <p>3.3 Insulation test :</p> <p>The insulation resistance is between pri to sec and windings to core measured by DC 500V, must be over 100MΩ.</p> <p>3.4 Terminal strength :</p> <p>1.0 Kg on terminals for 30 seconds, test the breakdown.</p>					
UNIT	m/m	DRAWN	CHECK	TITLE	TRANS
TEL	(02)2215-8302	Ci wun Chen	Guo long Huang	IDENT NO.	TRN-0272
FAX	(02)2215-8293	SEN HUEI INDUSTRIAL CO.,LTD.		DWG NO.	
No.26-1, Lane 128, Sec. 2, Singnan Rd., Jhonghe City, Taipei County 235, Taiwan (R.O.C.)					

Customer	SYSTEM GENERAL CORP.			P/N:	TRN-0272
DATE	08/24/2009	Version	A	Page	4/4

COMPONENT	MAT'L	MANUFACTURE	FILE NO.
1.Bobbin	Phenolic 94V-0,T373J,150°C	EE-16.(TF-1613) Chang Chun plastics co. ltd.	E59481(S)
2.Core	PC-40,BH2,2E6 3C85,NC-2H,	Ferrite core EE-16 TDK,Tokin.Tomita.Philip.Nicera.	
3.Wire	UEWE 130°C	Tai-I electric wire & cable co ltd.	E85640 S)
	UEW-2 130°C	Jung Shing wire co.,ltd	E174837
	UEW-B 130°C	Chuen Yih wire co.,ltd	E154709 S)
	TEX-E 105°C/120°C	Furukawa electric co.,ltd.	E206440
4.Varnish	BC-346A 180°C	John C Dolph co.,ltd.	E51047 M)
	468-2FC 130°C	Ripley resin engineering co inc.	E81777 N)
5.Tape t=0.064mm	31CT 130°C	Nitto denk corp	E34833 M)
	Polyester 3M #1350(b) 130°C	Minnesota mining &MFG co.,ltd. CTI material group	E17385 N)
6.Tube	Teflon tube TFL 150V,200°C	Great holding industrial co.,ltd.	E156256 S)
7.Terminals	Tin coated- Copper wire	Will fore special wire corp Hitachi cable lid	

MATERIALS LIST :

UNIT	m/m	DRAWN	CHECK	TITLE	TRANS
TEL	(02)29450588	Ci wun Chen	Guo long Huang	IDENT NO.	TRN-0272
FAX	(02)29447647	SEN HUEI INDUSTRIAL CO.,LTD..		DWG NO.	
No.26-1, Lane 128, Sec. 2, Singnan Rd., Jhonghe City, Taipei County 235, Taiwan (R.O.C.)					

9. Revision History

Rev.	Date	Description
1.0	Aug 25, 2011	Change User Guide EVB number from FEB310-003 V1.0 to FEBFSEZ1317A_CH310v3
1.0.0	Aug 30, 2011	Formatting & Editing pass by Tech Docs prior to posting
1.0.1	Nov 9, 2011	Replace Warning and Disclaimer Statement, format to new template

WARNING AND DISCLAIMER

Replace components on the Evaluation Board only with those parts shown on the parts list (or Bill of Materials) in the Users' Guide. Contact an authorized Fairchild representative with any questions.

This board is intended to be used by certified professionals, in a lab environment, following proper safety procedures. Use at your own risk. The Evaluation board (or kit) is for demonstration purposes only and neither the Board nor this User's Guide constitute a sales contract or create any kind of warranty, whether express or implied, as to the applications or products involved. Fairchild warrants that its products meet Fairchild's published specifications, but does not guarantee that its products work in any specific application. Fairchild reserves the right to make changes without notice to any products described herein to improve reliability, function, or design. Either the applicable sales contract signed by Fairchild and Buyer or, if no contract exists, Fairchild's standard Terms and Conditions on the back of Fairchild invoices, govern the terms of sale of the products described herein.

DISCLAIMER

FAIRCHILD SEMICONDUCTOR RESERVES THE RIGHT TO MAKE CHANGES WITHOUT FURTHER NOTICE TO ANY PRODUCTS HEREIN TO IMPROVE RELIABILITY, FUNCTION, OR DESIGN. FAIRCHILD DOES NOT ASSUME ANY LIABILITY ARISING OUT OF THE APPLICATION OR USE OF ANY PRODUCT OR CIRCUIT DESCRIBED HEREIN; NEITHER DOES IT CONVEY ANY LICENSE UNDER ITS PATENT RIGHTS, NOR THE RIGHTS OF OTHERS.

LIFE SUPPORT POLICY

FAIRCHILD'S PRODUCTS ARE NOT AUTHORIZED FOR USE AS CRITICAL COMPONENTS IN LIFE SUPPORT DEVICES OR SYSTEMS WITHOUT THE EXPRESS WRITTEN APPROVAL OF THE PRESIDENT OF FAIRCHILD SEMICONDUCTOR CORPORATION.

As used herein:

- Life support devices or systems are devices or systems which, (a) are intended for surgical implant into the body, or (b) support or sustain life, or (c) whose failure to perform when properly used in accordance with instructions for use provided in the labeling, can be reasonably expected to result in significant injury to the user.
- A critical component is any component of a life support device or system whose failure to perform can be reasonably expected to cause the failure of the life support device or system, or to affect its safety or effectiveness.

ANTI-COUNTERFEITING POLICY

Fairchild Semiconductor Corporation's Anti-Counterfeiting Policy. Fairchild's Anti-Counterfeiting Policy is also stated on our external website, www.fairchildsemi.com, under Sales Support.

Counterfeiting of semiconductor parts is a growing problem in the industry. All manufacturers of semiconductor products are experiencing counterfeiting of their parts. Customers who inadvertently purchase counterfeit parts experience many problems such as loss of brand reputation, substandard performance, failed applications, and increased cost of production and manufacturing delays. Fairchild is taking strong measures to protect ourselves and our customers from the proliferation of counterfeit parts. Fairchild strongly encourages customers to purchase Fairchild parts either directly from Fairchild or from Authorized Fairchild Distributors who are listed by country on our web page cited above. Products customers buy either from Fairchild directly or from Authorized Fairchild Distributors are genuine parts, have full traceability, meet Fairchild's quality standards for handling and storage and provide access to Fairchild's full range of up-to-date technical and product information. Fairchild and our Authorized Distributors will stand behind all warranties and will appropriately address any warranty issues that may arise. Fairchild will not provide any warranty coverage or other assistance for parts bought from Unauthorized Sources. Fairchild is committed to combat this global problem and encourage our customers to do their part in stopping this practice by buying direct or from authorized distributors.

EXPORT COMPLIANCE STATEMENT

These commodities, technology, or software were exported from the United States in accordance with the Export Administration Regulations for the ultimate destination listed on the commercial invoice. Diversion contrary to U.S. law is prohibited.

U.S. origin products and products made with U.S. origin technology are subject to U.S. Re-export laws. In the event of re-export, the user will be responsible to ensure the appropriate U.S. export regulations are followed.