

# NCS2500

## 1.1 mA 200 MHz Current Feedback Op Amp

NCS2500 is a 1.1 mA 200 MHz current feedback monolithic operational amplifier featuring high slew rate and low differential gain and phase error. The current feedback architecture allows for a superior bandwidth and low power consumption.

### Features

- -3.0 dB Small Signal BW ( $A_V = +2.0$ ,  $V_O = 0.5 V_{p-p}$ ) 200 MHz Typ
- Slew Rate 450 V/ $\mu$ s
- Supply Current 1.1 mA
- Input Referred Voltage Noise 4.0 nV/ $\sqrt{\text{Hz}}$
- THD -55 dB ( $f = 5.0$  MHz,  $V_O = 2.0 V_{p-p}$ )
- Output Current 100 mA
- Pin Compatible with EL5161, LMH6723, MAX4452
- Pb-Free Packages are Available

### Applications

- Portable Video
- Line Drivers
- Radar/Communication Receivers
- Set Top Box
- NTSC/PAL/HDTV

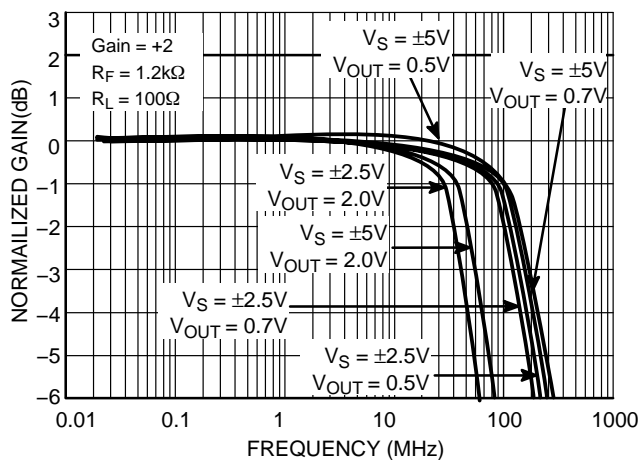

Figure 1. Frequency Response: Gain (dB) vs. Frequency  $A_V = +2.0$ ,  $R_L = 100 \Omega$



ON Semiconductor®

http://onsemi.com

### MARKING DIAGRAMS

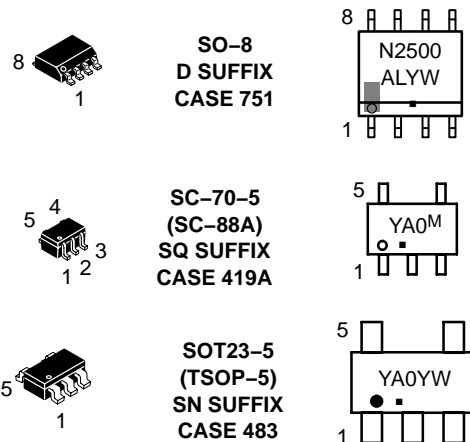

YA0, N2500 = NCS2500  
 A = Assembly Location  
 L = Wafer Lot  
 Y = Year  
 W = Work Week  
 M = Date Code  
 ■ = Pb-Free Package

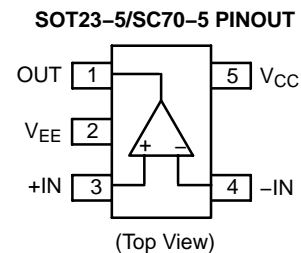
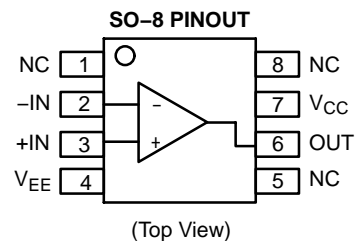

### ORDERING INFORMATION

See detailed ordering and shipping information in the package dimensions section on page 13 of this data sheet.

# NCS2500

## PIN FUNCTION DESCRIPTION

| Pin (SO-8) | Pin (SOT23/SC70) | Symbol          | Function              | Equivalent Circuit |
|------------|------------------|-----------------|-----------------------|--------------------|
| 6          | 1                | OUT             | Output                |                    |
| 4          | 2                | V <sub>EE</sub> | Negative Power Supply |                    |
| 3          | 3                | +IN             | Non-inverted Input    |                    |
| 2          | 4                | -IN             | Inverted Input        | See Above          |
| 7          | 5                | V <sub>CC</sub> | Positive Power Supply |                    |
| 1, 5, 8    | N/A              | NC              | No Connect            |                    |

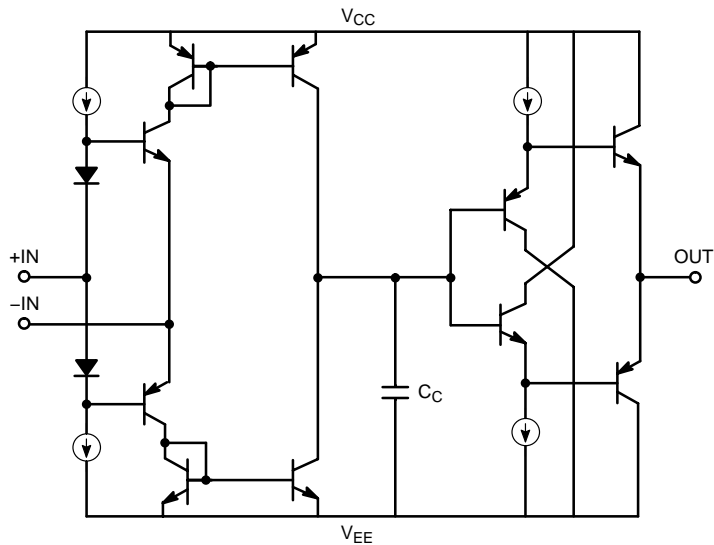

Figure 2. Simplified Device Schematic

# NCS2500

## ATTRIBUTES

| Characteristics                               | Value                |
|---|----------------------|
| ESD   |                      |
| Human Body Model                              | 2.0 kV (Note 1)      |
| Machine Model                                 | 200 V                |
| Charged Device Model                          | 1.0 kV               |
| Moisture Sensitivity (Note 2)                 | Level 1              |
| Flammability Rating    Oxygen Index: 28 to 34 | UL 94 V-0 @ 0.125 in |

- 0.8 kV between the input pairs +IN and -IN pins only. All other pins are 2.0 kV.
- For additional information, see Application Note AND8003/D.

## MAXIMUM RATINGS

| Parameter                             | Symbol          | Rating      | Unit          |
|---------------------------------------|-----------------|-------------|---------------|
| Power Supply Voltage                  | $V_S$           | 11          | $V_{DC}$      |
| Input Voltage Range                   | $V_I$           | $\leq V_S$  | $V_{DC}$      |
| Input Differential Voltage Range      | $V_{ID}$        | $\leq V_S$  | $V_{DC}$      |
| Output Current                        | $I_O$           | 100         | mA            |
| Maximum Junction Temperature (Note 3) | $T_J$           | 150         | $^{\circ}C$   |
| Operating Ambient Temperature         | $T_A$           | -40 to +85  | $^{\circ}C$   |
| Storage Temperature Range             | $T_{stg}$       | -60 to +150 | $^{\circ}C$   |
| Power Dissipation                     | $P_D$           | (See Graph) | mW            |
| Thermal Resistance, Junction-to-Air   | $R_{\theta JA}$ |             | $^{\circ}C/W$ |
| SO-8                                  |                 | 172         |               |
| SC70-5                                |                 | 215         |               |
| SOT23-5                               |                 | 154         |               |

Maximum ratings are those values beyond which device damage can occur. Maximum ratings applied to the device are individual stress limit values (not normal operating conditions) and are not valid simultaneously. If these limits are exceeded, device functional operation is not implied, damage may occur and reliability may be affected.

- Power dissipation must be considered to ensure maximum junction temperature ( $T_J$ ) is not exceeded.

## MAXIMUM POWER DISSIPATION

The maximum power that can be safely dissipated is limited by the associated rise in junction temperature. For the plastic packages, the maximum safe junction temperature is  $150^{\circ}C$ . If the maximum is exceeded momentarily, proper circuit operation will be restored as soon as the die temperature is reduced. Leaving the device in the "overheated" condition for an extended period can result in device damage.

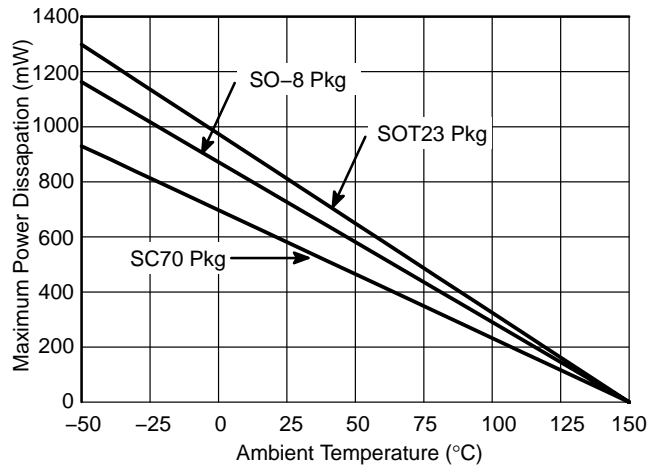

Figure 3. Power Dissipation vs. Temperature

# NCS2500

**AC ELECTRICAL CHARACTERISTICS** ( $V_{CC} = +5.0\text{ V}$ ,  $V_{EE} = -5.0\text{ V}$ ,  $T_A = -40^\circ\text{C}$  to  $+85^\circ\text{C}$ ,  $R_L = 100\ \Omega$  to GND,  $R_F = 1.2\text{ k}\Omega$ ,  $A_V = +2.0$ ,  $V_{IN} = 0\text{ V}$ , unless otherwise specified).

| Symbol | Characteristic | Conditions | Min | Typ | Max | Unit |
|--------|----------------|------------|-----|-----|-----|------|
|--------|----------------|------------|-----|-----|-----|------|

## FREQUENCY DOMAIN PERFORMANCE

|                     |   |  |  |            |  |     |
|---------------------|---|--|--|------------|--|-----|
| BW                  | Bandwidth<br>3.0 dB Small Signal<br>3.0 dB Large Signal | $A_V = +2.0$ , $V_O = 0.5\text{ V}_{p-p}$<br>$A_V = +2.0$ , $V_O = 2.0\text{ V}_{p-p}$ |  | 200<br>140 |  | MHz |
| GF <sub>0.1dB</sub> | 0.1 dB Gain Flatness<br>Bandwidth                       | $A_V = +2.0$   |  | 30         |  | MHz |
| dG                  | Differential Gain                                       | $A_V = +2.0$ , $R_L = 150\ \Omega$ , $f = 3.58\text{ MHz}$                             |  | 0.02       |  | %   |
| dP                  | Differential Phase                                      | $A_V = +2.0$ , $R_L = 150\ \Omega$ , $f = 3.58\text{ MHz}$                             |  | 0.1        |  | °   |

## TIME DOMAIN RESPONSE

|             |                                |  |  |          |  |                  |
|-------------|--------------------------------|--|--|----------|--|------------------|
| SR          | Slew Rate                      | $A_V = +2.0$ , $V_{step} = 2.0\text{ V}$   |  | 450      |  | V/ $\mu\text{s}$ |
| $t_s$       | Settling Time<br>0.01%<br>0.1% | $A_V = +2.0$ , $V_{step} = 2.0\text{ V}$<br>$A_V = +2.0$ , $V_{step} = 2.0\text{ V}$ |  | 35<br>18 |  | ns               |
| $t_r$ $t_f$ | Rise and Fall Time             | (10%–90%) $A_V = +2.0$ , $V_{step} = 2.0\text{ V}$                                   |  | 5.0      |  | ns               |

## HARMONIC/NOISE PERFORMANCE

|       |                              |  |  |          |  |                        |
|-------|------------------------------|--|--|----------|--|------------------------|
| THD   | Total Harmonic Distortion    | $f = 5.0\text{ MHz}$ , $V_O = 2.0\text{ V}_{p-p}$ , $R_L = 150\ \Omega$  |  | -55      |  | dB                     |
| HD2   | 2nd Harmonic Distortion      | $f = 5.0\text{ MHz}$ , $V_O = 2.0\text{ V}_{p-p}$                        |  | -67      |  | dBc                    |
| HD3   | 3rd Harmonic Distortion      | $f = 5.0\text{ MHz}$ , $V_O = 2.0\text{ V}_{p-p}$                        |  | -57      |  | dBc                    |
| IP3   | Third-Order Intercept        | $f = 10\text{ MHz}$ , $V_O = 2.0\text{ V}_{p-p}$                         |  | 35       |  | dBm                    |
| SFDR  | Spurious-Free Dynamic Range  | $f = 5.0\text{ MHz}$ , $V_O = 2.0\text{ V}_{p-p}$                        |  | 58       |  | dBc                    |
| $e_N$ | Input Referred Voltage Noise | $f = 1.0\text{ MHz}$   |  | 4.0      |  | nV/ $\sqrt{\text{Hz}}$ |
| $i_N$ | Input Referred Current Noise | $f = 1.0\text{ MHz}$ , Inverting<br>$f = 1.0\text{ MHz}$ , Non-Inverting |  | 15<br>15 |  | pA/ $\sqrt{\text{Hz}}$ |

# NCS2500

**DC ELECTRICAL CHARACTERISTICS** ( $V_{CC} = +5.0\text{ V}$ ,  $V_{EE} = -5.0\text{ V}$ ,  $T_A = -40^\circ\text{C}$  to  $+85^\circ\text{C}$ ,  $R_L = 100\ \Omega$  to GND,  $R_F = 1.2\text{ k}\Omega$ ,  $A_V = +2.0$ ,  $V_{IN} = 0\text{ V}$ , unless otherwise specified).

| Symbol | Characteristic | Conditions | Min | Typ | Max | Unit |
|--------|----------------|------------|-----|-----|-----|------|
|--------|----------------|------------|-----|-----|-----|------|

## DC PERFORMANCE

|                          |  |   |              |                        |              |                              |
|--------------------------|--|---|--------------|------------------------|--------------|------------------------------|
| $V_{OS}$                 | Offset Voltage                               |   | -4.0         | $\pm 0.7$              | +4.0         | mV                           |
| $\Delta V_{IO}/\Delta T$ | Input Offset Voltage Temperature Coefficient |   |              | 6.0                    |              | $\mu\text{V}/^\circ\text{C}$ |
| $I_{IB}$                 | Input Bias Current                           | +Input (Non-Inverting), $V_O = 0\text{ V}$<br>-Input (Inverting), $V_O = 0\text{ V}$ (Note 4) | -4.0<br>-4.0 | $\pm 2.0$<br>$\pm 0.4$ | +4.0<br>+4.0 | $\mu\text{A}$                |
| $\Delta I_{IB}/\Delta T$ | Input Bias Current Temperature Coefficient   | +Input (Non-Inverting), $V_O = 0\text{ V}$<br>-Input (Inverting), $V_O = 0\text{ V}$          |              | $\pm 40$<br>$\pm 10$   |              | $\text{nA}/^\circ\text{C}$   |

## INPUT CHARACTERISTICS

|          |  |  |           |            |    |                              |
|----------|--|--|-----------|------------|----|------------------------------|
| $V_{CM}$ | Input Common Mode Voltage Range (Note 4) |  | $\pm 3.0$ | $\pm 4.0$  |    | V                            |
| CMRR     | Common Mode Rejection Ratio              | (See Graph)                                  | 50        | 55         | 65 | dB                           |
| $R_{IN}$ | Input Resistance                         | +Input (Non-Inverting)<br>-Input (Inverting) |           | 4.0<br>350 |    | $\text{M}\Omega$<br>$\Omega$ |
| $C_{IN}$ | Differential Input Capacitance           |  |           | 1.0        |    | pF                           |

## OUTPUT CHARACTERISTICS

|           |                      |  |           |           |  |          |
|-----------|----------------------|--|-----------|-----------|--|----------|
| $R_{OUT}$ | Output Resistance    |  |           | 0.02      |  | $\Omega$ |
| $V_O$     | Output Voltage Swing |  | $\pm 3.0$ | $\pm 3.5$ |  | V        |
| $I_O$     | Output Current       |  | $\pm 60$  | $\pm 100$ |  | mA       |

## POWER SUPPLY

|       |                              |                    |     |     |     |    |
|-------|------------------------------|--------------------|-----|-----|-----|----|
| $V_S$ | Operating Voltage Supply     |                    |     | 10  |     | V  |
| $I_S$ | Power Supply Current         | $V_O = 0\text{ V}$ | 0.5 | 1.1 | 2.0 | mA |
| PSRR  | Power Supply Rejection Ratio | (See Graph)        | 50  | 60  | 70  | dB |

4. Guaranteed by design and/or characterization.

# NCS2500

**AC ELECTRICAL CHARACTERISTICS** ( $V_{CC} = +2.5\text{ V}$ ,  $V_{EE} = -2.5\text{ V}$ ,  $T_A = -40^\circ\text{C}$  to  $+85^\circ\text{C}$ ,  $R_L = 100\ \Omega$  to GND,  $R_F = 1.2\text{ k}\Omega$ ,  $A_V = +2.0$ ,  $V_{IN} = 0\text{ V}$ , unless otherwise specified).

| Symbol | Characteristic | Conditions | Min | Typ | Max | Unit |
|--------|----------------|------------|-----|-----|-----|------|
|--------|----------------|------------|-----|-----|-----|------|

## FREQUENCY DOMAIN PERFORMANCE

|                     |   |  |  |            |  |     |
|---------------------|---|--|--|------------|--|-----|
| BW                  | Bandwidth<br>3.0 dB Small Signal<br>3.0 dB Large Signal | $A_V = +2.0$ , $V_O = 0.5\text{ V}_{p-p}$<br>$A_V = +2.0$ , $V_O = 1.0\text{ V}_{p-p}$ |  | 180<br>130 |  | MHz |
| GF <sub>0.1dB</sub> | 0.1 dB Gain Flatness<br>Bandwidth                       | $A_V = +2.0$   |  | 15         |  | MHz |
| dG                  | Differential Gain                                       | $A_V = +2.0$ , $R_L = 150\ \Omega$ , $f = 3.58\text{ MHz}$                             |  | 0.02       |  | %   |
| dP                  | Differential Phase                                      | $A_V = +2.0$ , $R_L = 150\ \Omega$ , $f = 3.58\text{ MHz}$                             |  | 0.1        |  | °   |

## TIME DOMAIN RESPONSE

|             |                                |  |  |          |  |                  |
|-------------|--------------------------------|--|--|----------|--|------------------|
| SR          | Slew Rate                      | $A_V = +2.0$ , $V_{step} = 1.0\text{ V}$   |  | 350      |  | V/ $\mu\text{s}$ |
| $t_s$       | Settling Time<br>0.01%<br>0.1% | $A_V = +2.0$ , $V_{step} = 1.0\text{ V}$<br>$A_V = +2.0$ , $V_{step} = 1.0\text{ V}$ |  | 40<br>18 |  | ns               |
| $t_r$ $t_f$ | Rise and Fall Time             | (10%–90%) $A_V = +2.0$ , $V_{step} = 1.0\text{ V}$                                   |  | 8.0      |  | ns               |

## HARMONIC/NOISE PERFORMANCE

|       |                              |  |  |          |  |                        |
|-------|------------------------------|--|--|----------|--|------------------------|
| THD   | Total Harmonic Distortion    | $f = 5.0\text{ MHz}$ , $V_O = 1.0\text{ V}_{p-p}$ , $R_L = 150\ \Omega$  |  | -55      |  | dB                     |
| HD2   | 2nd Harmonic Distortion      | $f = 5.0\text{ MHz}$ , $V_O = 1.0\text{ V}_{p-p}$                        |  | -67      |  | dBc                    |
| HD3   | 3rd Harmonic Distortion      | $f = 5.0\text{ MHz}$ , $V_O = 1.0\text{ V}_{p-p}$                        |  | -57      |  | dBc                    |
| IP3   | Third-Order Intercept        | $f = 10\text{ MHz}$ , $V_O = 1.0\text{ V}_{p-p}$                         |  | 35       |  | dBm                    |
| SFDR  | Spurious-Free Dynamic Range  | $f = 5.0\text{ MHz}$ , $V_O = 1.0\text{ V}_{p-p}$                        |  | 58       |  | dBc                    |
| $e_N$ | Input Referred Voltage Noise | $f = 1.0\text{ MHz}$   |  | 4.0      |  | nV/ $\sqrt{\text{Hz}}$ |
| $i_N$ | Input Referred Current Noise | $f = 1.0\text{ MHz}$ , Inverting<br>$f = 1.0\text{ MHz}$ , Non-Inverting |  | 15<br>15 |  | pA/ $\sqrt{\text{Hz}}$ |

# NCS2500

**DC ELECTRICAL CHARACTERISTICS** ( $V_{CC} = +2.5\text{ V}$ ,  $V_{EE} = -2.5\text{ V}$ ,  $T_A = -40^\circ\text{C}$  to  $+85^\circ\text{C}$ ,  $R_L = 100\ \Omega$  to GND,  $R_F = 1.2\text{ k}\Omega$ ,  $A_V = +2.0$ ,  $V_{IN} = 0\text{ V}$ , unless otherwise specified).

| Symbol | Characteristic | Conditions | Min | Typ | Max | Unit |
|--------|----------------|------------|-----|-----|-----|------|
|--------|----------------|------------|-----|-----|-----|------|

## DC PERFORMANCE

|                          |  |   |              |                        |              |                              |
|--------------------------|--|---|--------------|------------------------|--------------|------------------------------|
| $V_{OS}$                 | Offset Voltage                               |   | -4.0         | $\pm 0.5$              | +4.0         | mV                           |
| $\Delta V_{IO}/\Delta T$ | Input Offset Voltage Temperature Coefficient |   |              | 6.0                    |              | $\mu\text{V}/^\circ\text{C}$ |
| $I_{IB}$                 | Input Bias Current                           | +Input (Non-Inverting), $V_O = 0\text{ V}$<br>-Input (Inverting), $V_O = 0\text{ V}$ (Note 5) | -4.0<br>-4.0 | $\pm 2.0$<br>$\pm 0.4$ | +4.0<br>+4.0 | $\mu\text{A}$                |
| $\Delta I_{IB}/\Delta T$ | Input Bias Current Temperature Coefficient   | +Input (Non-Inverting), $V_O = 0\text{ V}$<br>-Input (Inverting), $V_O = 0\text{ V}$          |              | $\pm 40$<br>$\pm 10$   |              | $\text{nA}/^\circ\text{C}$   |

## INPUT CHARACTERISTICS

|          |  |  |           |            |    |                              |
|----------|--|--|-----------|------------|----|------------------------------|
| $V_{CM}$ | Input Common Mode Voltage Range (Note 5) |  | $\pm 1.3$ | $\pm 1.5$  |    | V                            |
| CMRR     | Common Mode Rejection Ratio              | (See Graph)                                  | 50        | 55         | 65 | dB                           |
| $R_{IN}$ | Input Resistance                         | +Input (Non-Inverting)<br>-Input (Inverting) |           | 4.0<br>350 |    | $\text{M}\Omega$<br>$\Omega$ |
| $C_{IN}$ | Differential Input Capacitance           |  |           | 1.0        |    | pF                           |

## OUTPUT CHARACTERISTICS

|           |                      |  |           |           |  |          |
|-----------|----------------------|--|-----------|-----------|--|----------|
| $R_{OUT}$ | Output Resistance    |  |           | 0.02      |  | $\Omega$ |
| $V_O$     | Output Voltage Swing |  | $\pm 1.1$ | $\pm 1.4$ |  | V        |
| $I_O$     | Output Current       |  | $\pm 40$  | $\pm 80$  |  | mA       |

## POWER SUPPLY

|       |                              |                    |     |     |     |    |
|-------|------------------------------|--------------------|-----|-----|-----|----|
| $V_S$ | Operating Voltage Supply     |                    |     | 5.0 |     | V  |
| $I_S$ | Power Supply Current         | $V_O = 0\text{ V}$ | 0.5 | 0.9 | 1.9 | mA |
| PSRR  | Power Supply Rejection Ratio | (See Graph)        | 50  | 60  | 70  | dB |

5. Guaranteed by design and/or characterization.

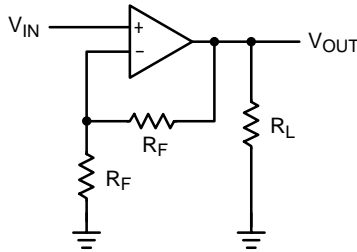

**Figure 4. Typical Test Setup**  
( $A_V = +2.0$ ,  $R_F = 1.8\text{ k}\Omega$  or  $1.2\text{ k}\Omega$  or  $1.0\text{ k}\Omega$ ,  $R_L = 100\ \Omega$ )

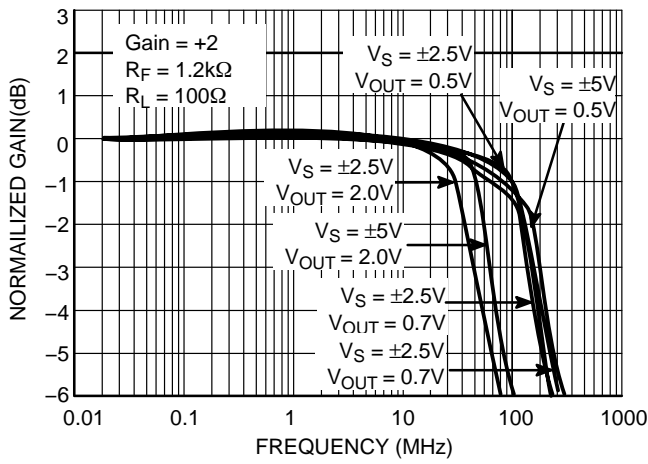

**Figure 5. Frequency Response:**  
Gain (dB) vs. Frequency  
 $A_v = +2.0$

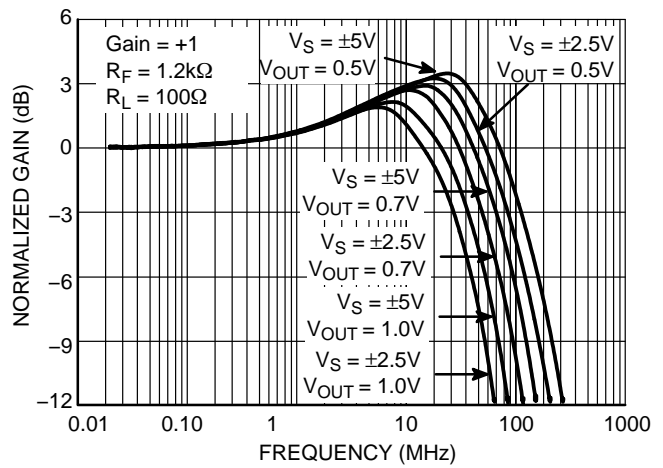

**Figure 6. Frequency Response:**  
Gain (dB) vs. Frequency  
 $A_v = +1.0$

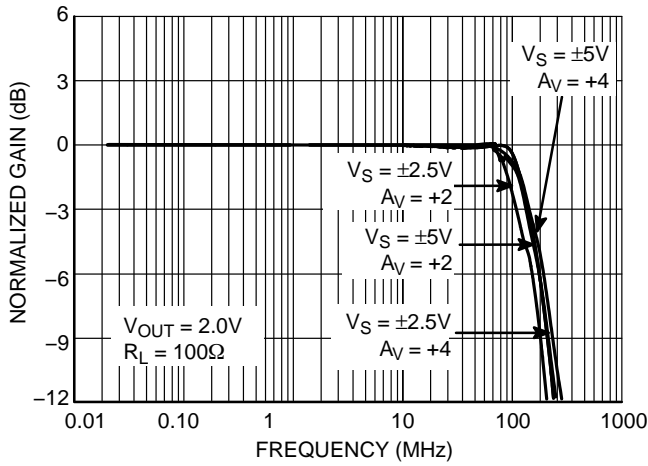

**Figure 7. Large Signal Frequency Response**  
Gain (dB) vs. Frequency

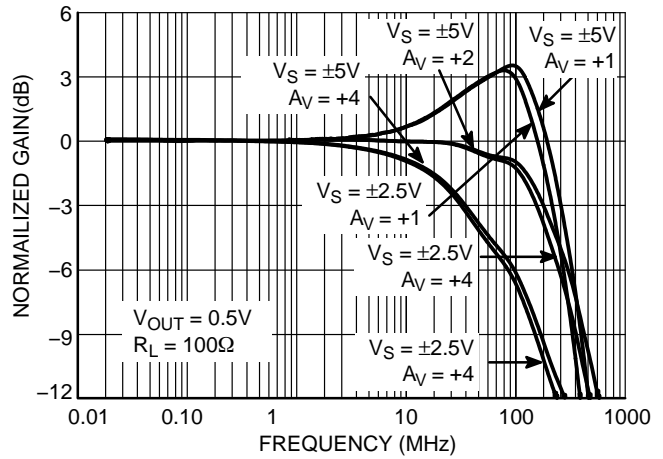

**Figure 8. Small Signal Frequency Response**  
Gain (dB) vs. Frequency

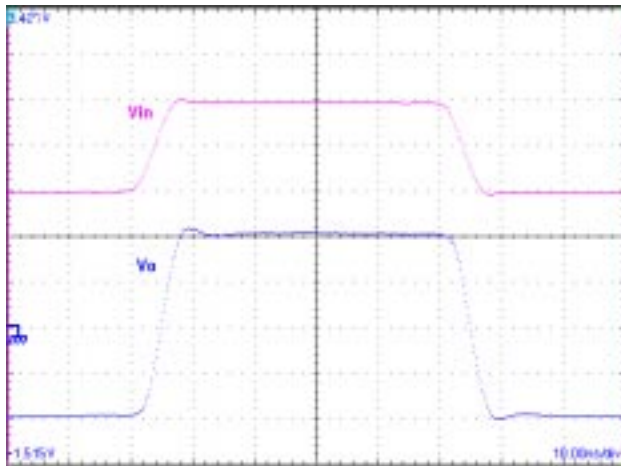

**Figure 9. Small Signal Step Response**  
Vertical: 500 mV/div  
Horizontal: 10 ns/div

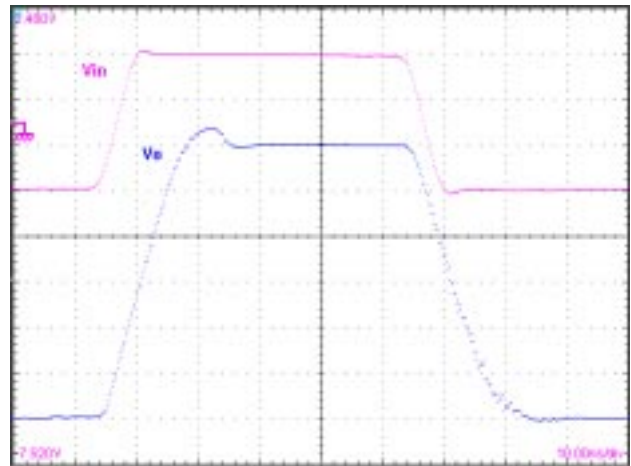

**Figure 10. Large Signal Step Response**  
Vertical: 500 mV/div  
Horizontal: 10 ns/div



# NCS2500

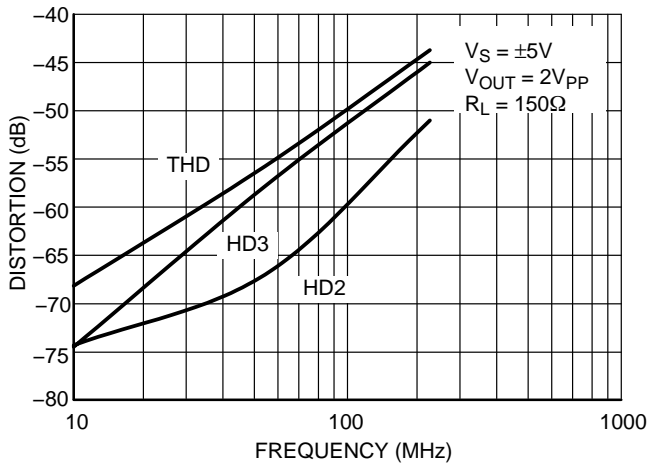

Figure 11. THD, HD2, HD3 vs. Frequency

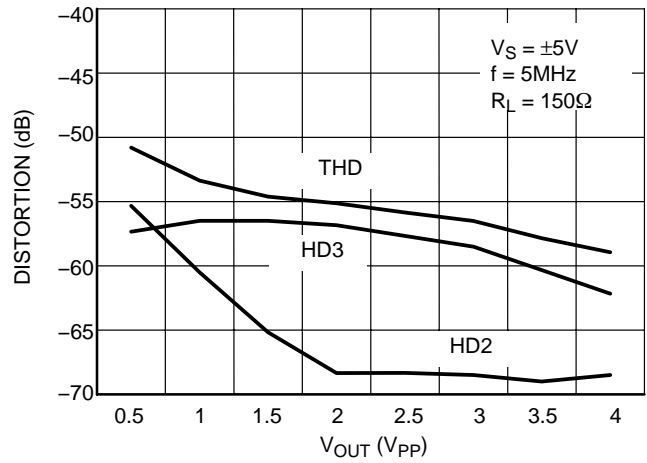

Figure 12. THD, HD2, HD3 vs. Output Voltage

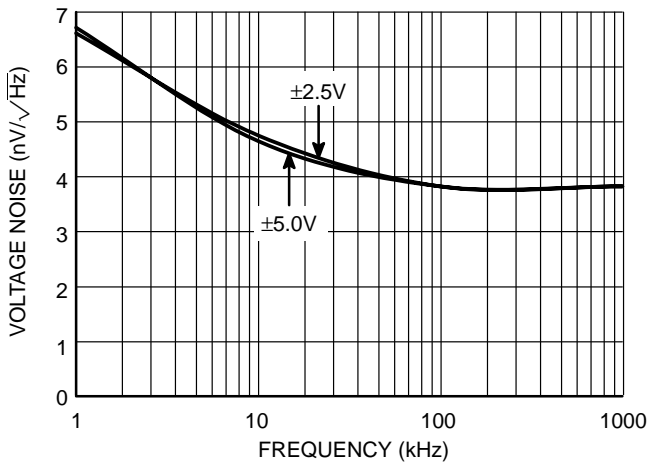

Figure 13. Input Referred Noise vs. Frequency

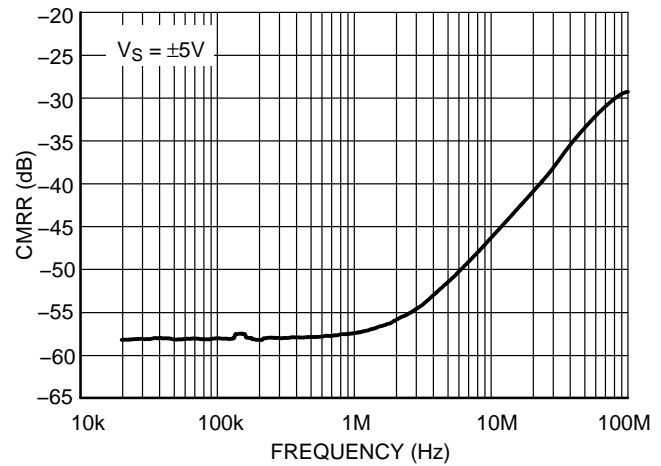

Figure 14. CMRR vs. Frequency

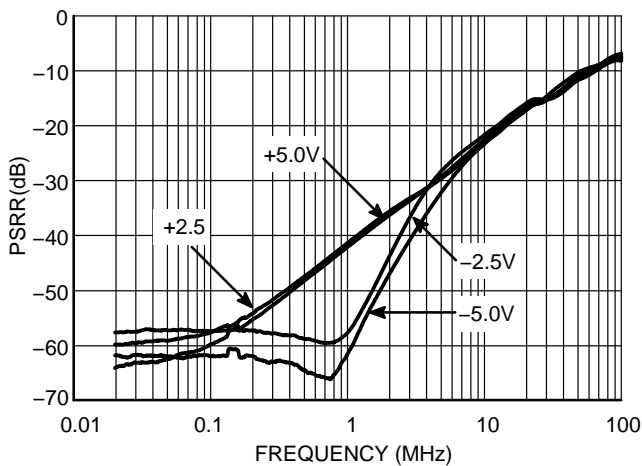

Figure 15. PSRR vs. Frequency

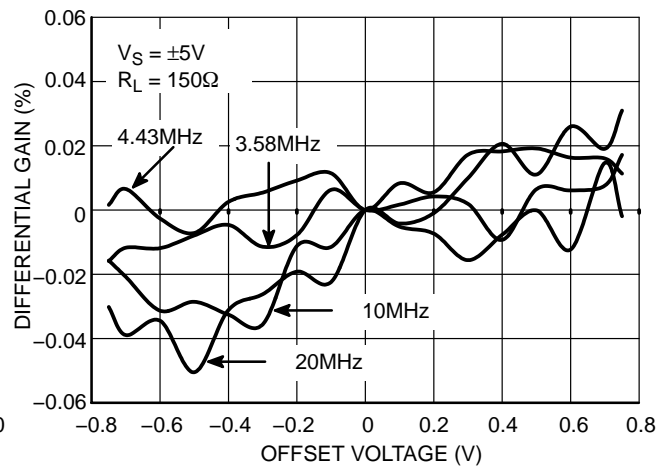

Figure 16. Differential Gain

# NCS2500

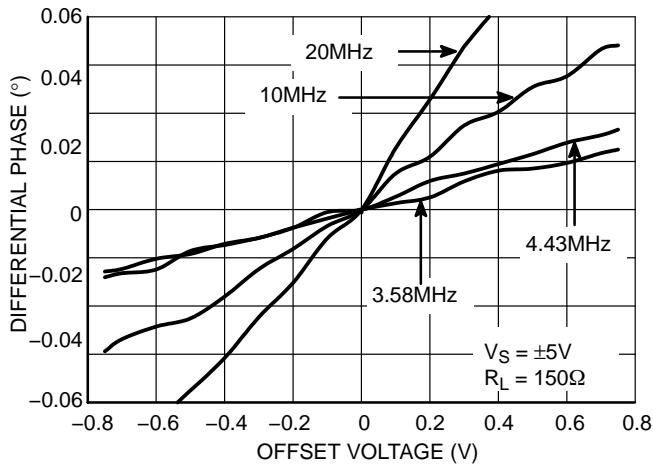

Figure 17. Differential Phase

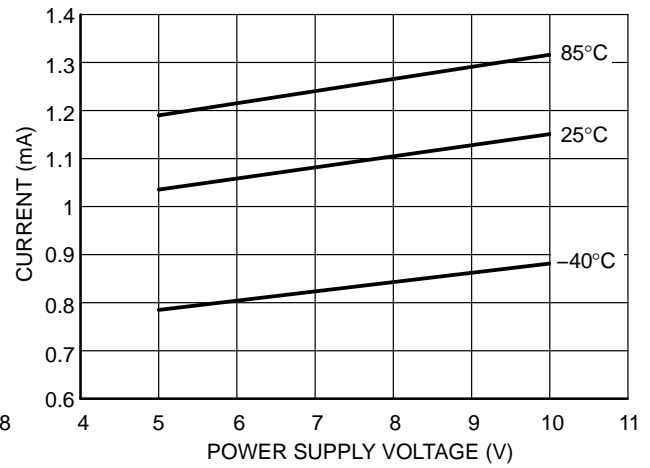

Figure 18. Supply Current vs. Power Supply

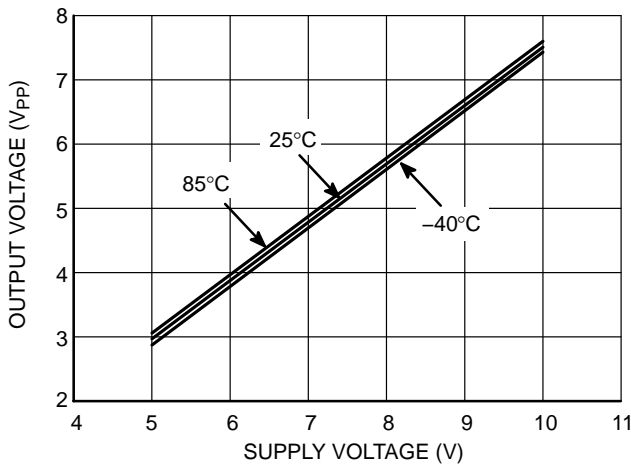

Figure 19. Output Voltage Swing vs. Supply Voltage

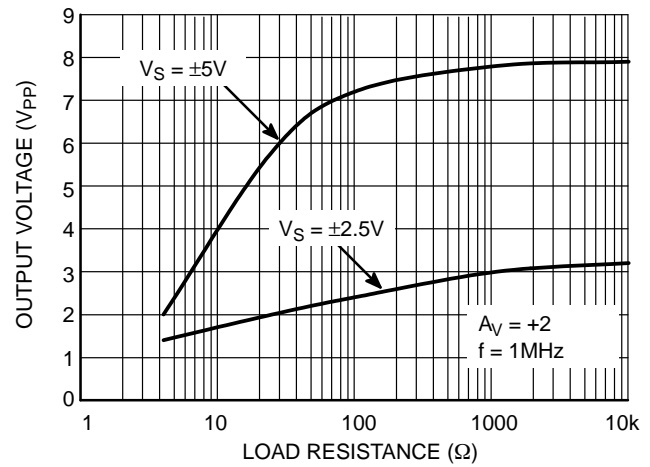

Figure 20. Output Voltage Swing vs. Load Resistance

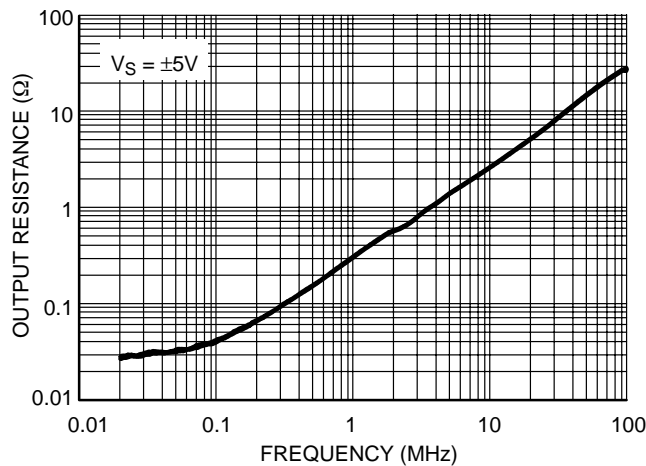

Figure 21. Output Impedance vs. Frequency

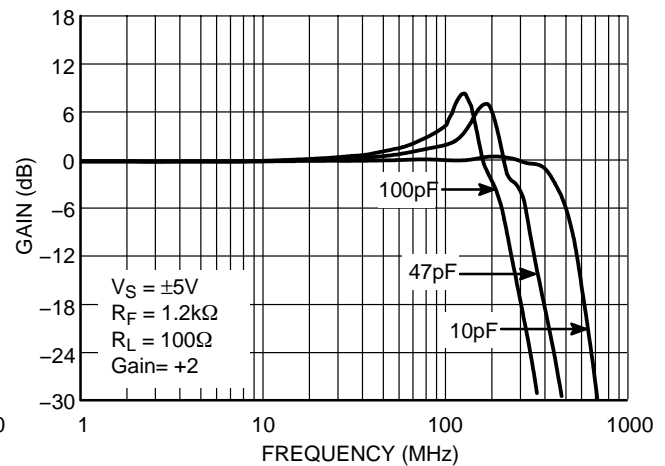
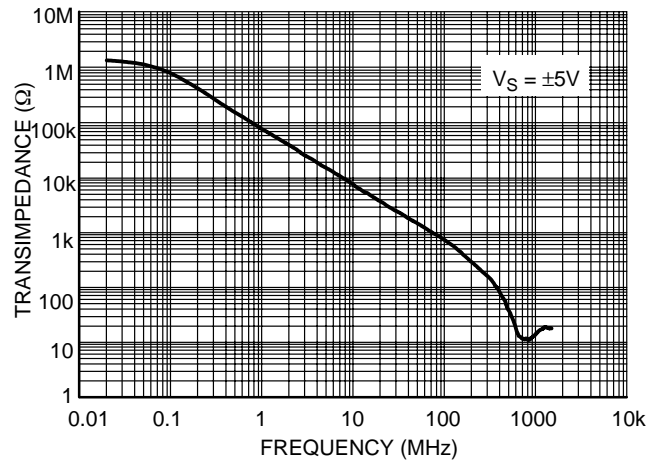

Figure 22. Frequency Response vs. CL

# NCS2500



**Figure 23. Transimpedance (ROL) vs. Frequency**

### General Design Considerations

The current feedback amplifier is optimized for use in high performance video and data acquisition systems. For current feedback architecture, its closed-loop bandwidth depends on the value of the feedback resistor. The closed-loop bandwidth is not a strong function of gain, as is for a voltage feedback amplifier, as shown in Figure 24.

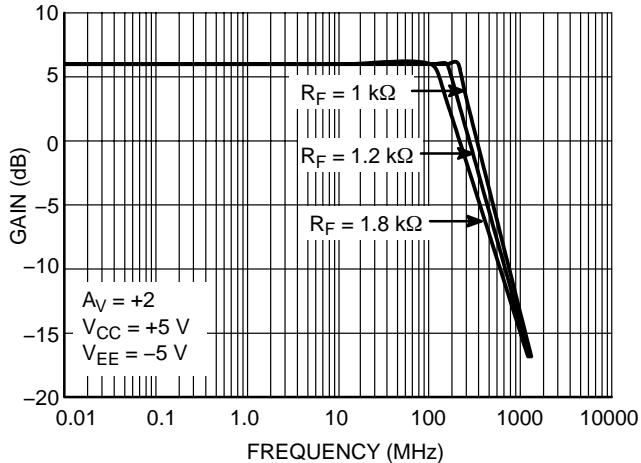

Figure 24. Frequency Response vs.  $R_F$

The  $-3.0$  dB bandwidth is, to some extent, dependent on the power supply voltages. By using lower power supplies, the bandwidth is reduced, because the internal capacitance increases. Smaller values of feedback resistor can be used at lower supply voltages, to compensate for this affect.

### Feedback and Gain Resistor Selection for Optimum Frequency Response

A current feedback operational amplifier's key advantage is the ability to maintain optimum frequency response independent of gain by using appropriate values for the feedback resistor. To obtain a very flat gain response, the feedback resistor tolerance should be considered as well. Resistor tolerance of 1% should be used for optimum flatness. Normally, lowering  $R_F$  resistor from its recommended value will peak the frequency response and extend the bandwidth while increasing the value of  $R_F$  resistor will cause the frequency response to roll off faster. Reducing the value of  $R_F$

resistor too far below its recommended value will cause overshoot, ringing, and eventually oscillation.

Since each application is slightly different, it is worth some experimentation to find the optimal  $R_F$  for a given circuit. A value of the feedback resistor that produces  $\sim 0.1$  dB of peaking is the best compromise between stability and maximal bandwidth. It is not recommended to use a current feedback amplifier with the output shorted directly to the inverting input.

### Printed Circuit Board Layout Techniques

Proper high speed PCB design rules should be used for all wideband amplifiers as the PCB parasitics can affect the overall performance. Most important are stray capacitances at the output and inverting input nodes as it can effect peaking and bandwidth. A space (3/16" is plenty) should be left around the signal lines to minimize coupling. Also, signal lines connecting the feedback and gain resistors should be short enough so that their associated inductance does not cause high frequency gain errors. Line lengths less than 1/4" are recommended.

### Video Performance

This device designed to provide good performance with NTSC, PAL, and HDTV video signals. Best performance is obtained with back terminated loads as performance is degraded as the load is increased. The back termination reduces reflections from the transmission line and effectively masks transmission line and other parasitic capacitances from the amplifier output stage.

### ESD Protection

This device is protected against electrostatic discharge (ESD) on all pins as specified in the attributes table. Note: Human Body Model for +IN and -IN pins are rated at 0.8 kV while all other pins are rated at 2.0 kV. Under closed-loop operation, the ESD diodes have no effect on circuit performance. However, under certain conditions the ESD diodes will be evident. If the device is driven into a slewing condition, the ESD diodes will clamp large differential voltages until the feedback loop restores closed-loop operation. Also, if the device is powered down and a large input signal is applied, the ESD diodes will conduct.

# NCS2500

## ORDERING INFORMATION

| Device       | Package                       | Shipping†        |
|--------------|-------------------------------|------------------|
| NCS2500SQT2  | SC70-5 (SC88A)                | 3000 Tape & Reel |
| NCS2500SQT2G | SC70-5 (SC88A)<br>(Pb-Free)   | 3000 Tape & Reel |
| NCS2500SNT1  | SOT23-5 (TSOP-5)              | 3000 Tape & Reel |
| NCS2500SNT1G | SOT23-5 (TSOP-5)<br>(Pb-Free) | 3000 Tape & Reel |
| NCS2500D*    | SO-8                          | 98 Units/Rail    |
| NCS2500DR2*  | SO-8                          | 2500 Tape & Reel |
| NCS2500DG*   | SO-8<br>(Pb-Free)             | 98 Units/Rail    |
| NCS2500DR2G* | SO-8<br>(Pb-Free)             | 2500 Tape & Reel |

†For information on tape and reel specifications, including part orientation and tape sizes, please refer to our Tape and Reel Packaging Specifications Brochure, BRD8011/D.

\*Contact ON Semiconductor for ordering information.

# NCS2500

## PACKAGE DIMENSIONS

SO-8  
D SUFFIX  
CASE 751-07  
ISSUE AF

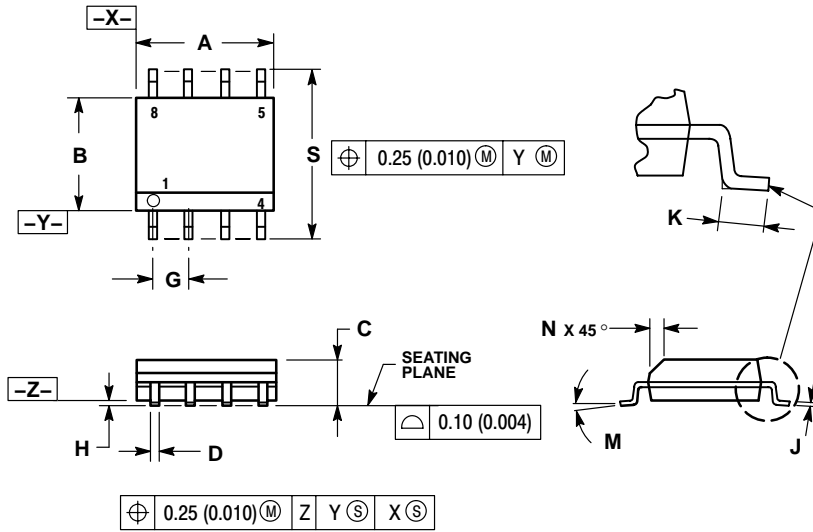

### NOTES:

1. DIMENSIONING AND TOLERANCING PER ANSI Y14.5M, 1982.
2. CONTROLLING DIMENSION: MILLIMETER.
3. DIMENSION A AND B DO NOT INCLUDE MOLD PROTRUSION.
4. MAXIMUM MOLD PROTRUSION 0.15 (0.006) PER SIDE.
5. DIMENSION D DOES NOT INCLUDE DAMBAR PROTRUSION. ALLOWABLE DAMBAR PROTRUSION SHALL BE 0.127 (0.005) TOTAL IN EXCESS OF THE D DIMENSION AT MAXIMUM MATERIAL CONDITION.
6. 751-01 THRU 751-06 ARE OBSOLETE. NEW STANDARD IS 751-07.

| DIM | MILLIMETERS |      | INCHES    |       |
|-----|-------------|------|-----------|-------|
|     | MIN         | MAX  | MIN       | MAX   |
| A   | 4.80        | 5.00 | 0.189     | 0.197 |
| B   | 3.80        | 4.00 | 0.150     | 0.157 |
| C   | 1.35        | 1.75 | 0.053     | 0.069 |
| D   | 0.33        | 0.51 | 0.013     | 0.020 |
| G   | 1.27 BSC    |      | 0.050 BSC |       |
| H   | 0.10        | 0.25 | 0.004     | 0.010 |
| J   | 0.19        | 0.25 | 0.007     | 0.010 |
| K   | 0.40        | 1.27 | 0.016     | 0.050 |
| M   | 0°          | 8°   | 0°        | 8°    |
| N   | 0.25        | 0.50 | 0.010     | 0.020 |
| S   | 5.80        | 6.20 | 0.228     | 0.244 |

### SOLDERING FOOTPRINT\*

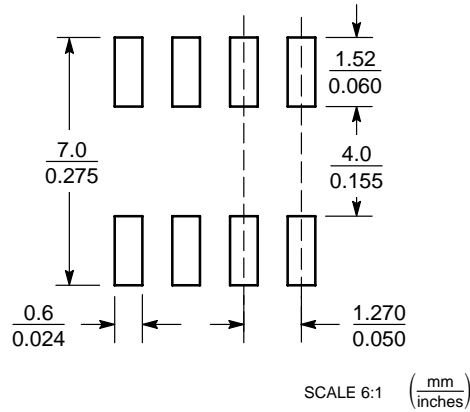

\*For additional information on our Pb-Free strategy and soldering details, please download the ON Semiconductor Soldering and Mounting Techniques Reference Manual, SOLDERRM/D.

# NCS2500

## PACKAGE DIMENSIONS

SC-70-5 (SC-88A)  
SQ SUFFIX  
CASE 419A-02  
ISSUE G

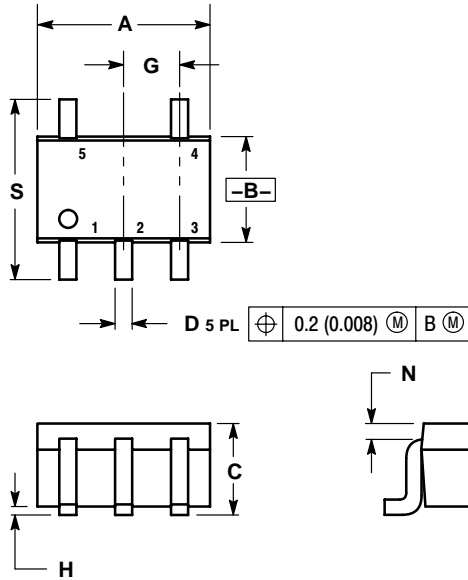

**NOTES:**

1. DIMENSIONING AND TOLERANCING PER ANSI Y14.5M, 1982.
2. CONTROLLING DIMENSION: INCH.
3. 419A-01 OBSOLETE. NEW STANDARD 419A-02.
4. DIMENSIONS A AND B DO NOT INCLUDE MOLD FLASH, PROTRUSIONS, OR GATE BURRS.

| DIM | INCHES    |       | MILLIMETERS |      |
|-----|-----------|-------|-------------|------|
|     | MIN       | MAX   | MIN         | MAX  |
| A   | 0.071     | 0.087 | 1.80        | 2.20 |
| B   | 0.045     | 0.053 | 1.15        | 1.35 |
| C   | 0.031     | 0.043 | 0.80        | 1.10 |
| D   | 0.004     | 0.012 | 0.10        | 0.30 |
| G   | 0.026 BSC |       | 0.65 BSC    |      |
| H   | ---       | 0.004 | ---         | 0.10 |
| J   | 0.004     | 0.010 | 0.10        | 0.25 |
| K   | 0.004     | 0.012 | 0.10        | 0.30 |
| N   | 0.008 REF |       | 0.20 REF    |      |
| S   | 0.079     | 0.087 | 2.00        | 2.20 |

### SOLDERING FOOTPRINT\*

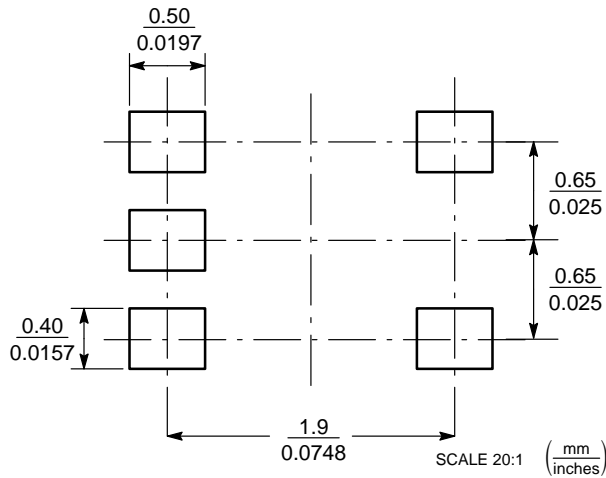

\*For additional information on our Pb-Free strategy and soldering details, please download the ON Semiconductor Soldering and Mounting Techniques Reference Manual, SOLDERRM/D.

# NCS2500

## PACKAGE DIMENSIONS

SOT23-5 (TSOP-5)  
SN SUFFIX  
CASE 483-02  
ISSUE C

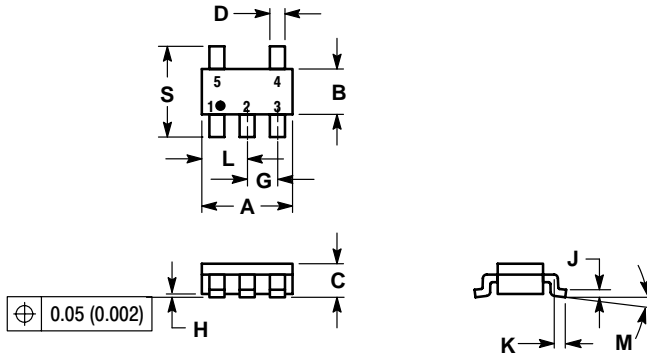

### NOTES:

1. DIMENSIONING AND TOLERANCING PER ANSI Y14.5M, 1982.
2. CONTROLLING DIMENSION: MILLIMETER.
3. MAXIMUM LEAD THICKNESS INCLUDES LEAD FINISH THICKNESS. MINIMUM LEAD THICKNESS IS THE MINIMUM THICKNESS OF BASE MATERIAL.
4. A AND B DIMENSIONS DO NOT INCLUDE MOLD FLASH, PROTRUSIONS, OR GATE BURRS.

| DIM | MILLIMETERS |       | INCHES |        |
|-----|-------------|-------|--------|--------|
|     | MIN         | MAX   | MIN    | MAX    |
| A   | 2.90        | 3.10  | 0.1142 | 0.1220 |
| B   | 1.30        | 1.70  | 0.0512 | 0.0669 |
| C   | 0.90        | 1.10  | 0.0354 | 0.0433 |
| D   | 0.25        | 0.50  | 0.0098 | 0.0197 |
| G   | 0.85        | 1.05  | 0.0335 | 0.0413 |
| H   | 0.013       | 0.100 | 0.0005 | 0.0040 |
| J   | 0.10        | 0.26  | 0.0040 | 0.0102 |
| K   | 0.20        | 0.60  | 0.0079 | 0.0236 |
| L   | 1.25        | 1.55  | 0.0493 | 0.0610 |
| M   | 0           | 10    | 0      | 10     |
| S   | 2.50        | 3.00  | 0.0985 | 0.1181 |

ON Semiconductor and  are registered trademarks of Semiconductor Components Industries, LLC (SCILLC). SCILLC reserves the right to make changes without further notice to any products herein. SCILLC makes no warranty, representation or guarantee regarding the suitability of its products for any particular purpose, nor does SCILLC assume any liability arising out of the application or use of any product or circuit, and specifically disclaims any and all liability, including without limitation special, consequential or incidental damages. "Typical" parameters which may be provided in SCILLC data sheets and/or specifications can and do vary in different applications and actual performance may vary over time. All operating parameters, including "Typicals" must be validated for each customer application by customer's technical experts. SCILLC does not convey any license under its patent rights nor the rights of others. SCILLC products are not designed, intended, or authorized for use as components in systems intended for surgical implant into the body, or other applications intended to support or sustain life, or for any other application in which the failure of the SCILLC product could create a situation where personal injury or death may occur. Should Buyer purchase or use SCILLC products for any such unintended or unauthorized application, Buyer shall indemnify and hold SCILLC and its officers, employees, subsidiaries, affiliates, and distributors harmless against all claims, costs, damages, and expenses, and reasonable attorney fees arising out of, directly or indirectly, any claim of personal injury or death associated with such unintended or unauthorized use, even if such claim alleges that SCILLC was negligent regarding the design or manufacture of the part. SCILLC is an Equal Opportunity/Affirmative Action Employer. This literature is subject to all applicable copyright laws and is not for resale in any manner.

### PUBLICATION ORDERING INFORMATION

#### LITERATURE FULFILLMENT:

Literature Distribution Center for ON Semiconductor  
P.O. Box 61312, Phoenix, Arizona 85082-1312 USA  
Phone: 480-829-7710 or 800-344-3860 Toll Free USA/Canada  
Fax: 480-829-7709 or 800-344-3867 Toll Free USA/Canada  
Email: orderlit@onsemi.com

N. American Technical Support: 800-282-9855 Toll Free  
USA/Canada

Japan: ON Semiconductor, Japan Customer Focus Center  
2-9-1 Kamimeguro, Meguro-ku, Tokyo, Japan 153-0051  
Phone: 81-3-5773-3850

ON Semiconductor Website: <http://onsemi.com>

Order Literature: <http://www.onsemi.com/litorder>

For additional information, please contact your local Sales Representative.

NCS2500/D