

DATA SHEET

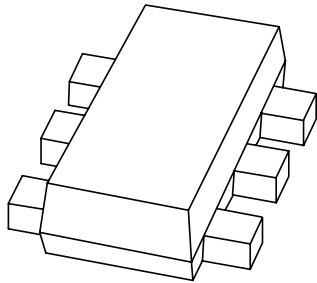

PEMZ7 NPN/PNP general purpose transistors

Product data sheet
Supersedes data of 2001 Sep 25

2001 Nov 07



NPN/PNP general purpose transistors

PEMZ7

FEATURES

- 300 mW total power dissipation
- Very small 1.6 × 1.2 mm ultra thin package
- Self alignment during soldering due to straight leads
- Low collector capacitance
- Low V_{CEsat}
- High current capabilities
- Improved thermal behaviour due to flat leads
- Reduced required PCB area
- Reduced pick and place costs.

APPLICATIONS

- Heavy duty battery powered equipment (automotive, telecom and audio-video) such as motor and lamp drivers
- V_{CEsat} critical applications such as latest low supply voltage IC applications
- All battery driven equipment, to save battery power.

DESCRIPTION

NPN/PNP low V_{CEsat} transistor pair in a SOT666 plastic package.

MARKING

TYPE NUMBER	MARKING CODE
PEMZ7	Z7

PINNING

PIN	DESCRIPTION
1, 4	emitter TR1; TR2
2, 5	base TR1; TR2
6, 3	collector TR1; TR2

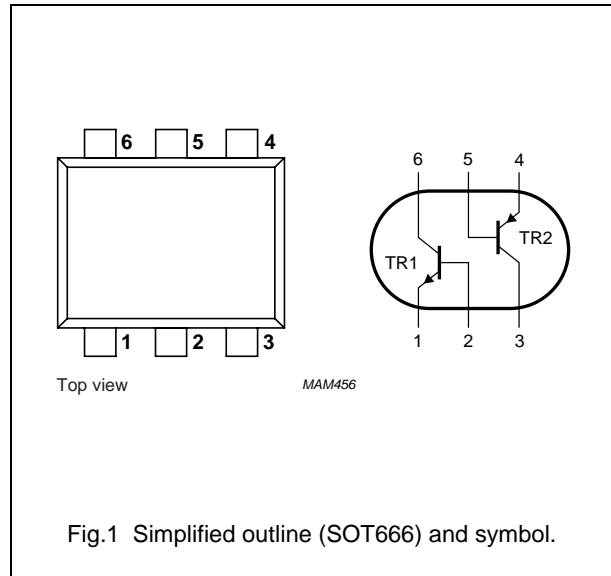

NPN/PNP general purpose transistors

PEMZ7

LIMITING VALUES

In accordance with the Absolute Maximum Rating System (IEC 60134).

SYMBOL	PARAMETER	CONDITIONS	MIN.	MAX.	UNIT
Per transistor; for the PNP transistor with negative polarity					
V _{CBO}	collector-base voltage	open emitter	–	15	V
V _{CEO}	collector-emitter voltage	open base	–	12	V
V _{EBO}	emitter-base voltage	open collector	–	6	V
I _C	collector current (DC)		–	500	mA
I _{CM}	peak collector current		–	1	A
I _{BM}	peak base current		–	100	mA
P _{tot}	total power dissipation	T _{amb} ≤ 25 °C; note 1	–	200	mW
T _{stg}	storage temperature		–65	+150	°C
T _j	junction temperature		–	150	°C
T _{amb}	operating ambient temperature		–65	+150	°C
Per device					
P _{tot}	total power dissipation	T _{amb} ≤ 25 °C; note 1	–	300	mW

Note

1. Transistor mounted on an FR4 printed-circuit board.

THERMAL CHARACTERISTICS

SYMBOL	PARAMETER	CONDITIONS	VALUE	UNIT
R _{th j-a}	thermal resistance from junction to ambient	notes 1 and 2	416	K/W

Notes

1. Transistor mounted on an FR4 printed-circuit board.
2. The only recommended soldering method is reflow soldering.

NPN/PNP general purpose transistors

PEMZ7

CHARACTERISTICS

T_{amb} = 25 °C; unless otherwise specified.

SYMBOL	PARAMETER	CONDITIONS	MIN.	TYP.	MAX.	UNIT
Per transistor; for the PNP transistor with negative polarity						
I _{CBO}	collector-base cut-off current	V _{CB} = 15 V; I _E = 0	–	–	100	nA
		V _{CB} = 15 V; I _E = 0; T _J = 150 °C	–	–	50	μA
I _{EBO}	emitter-base cut-off current	V _{EB} = 5 V; I _C = 0	–	–	100	nA
h _{FE}	DC current gain	V _{CE} = 2 V; I _C = 10 mA	200	–	–	
V _{CEsat}	collector-emitter saturation voltage	I _C = 200 mA; I _B = 10 mA	–	–	220	mV
f _T	transition frequency TR1 (NPN) TR2 (PNP)	I _C = 100 mA; V _{CE} = 5 V; f = 100 MHz	250	420	–	MHz
			100	280	–	MHz
C _c	collector capacitance TR1 (NPN) TR2 (PNP)	V _{CB} = 10 V; I _E = I _e = 0; f = 1 MHz	–	4.4	6	pF
			–	–	10	pF
			–	–	–	–

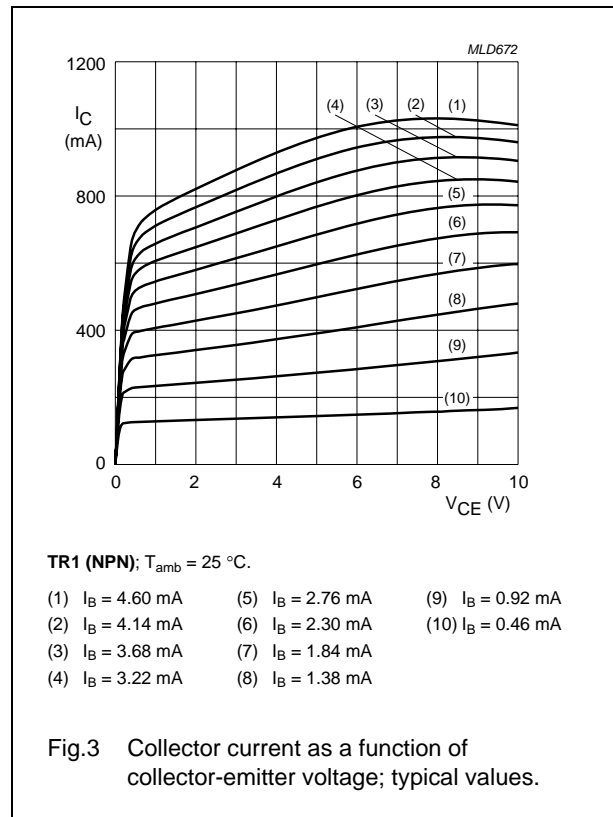
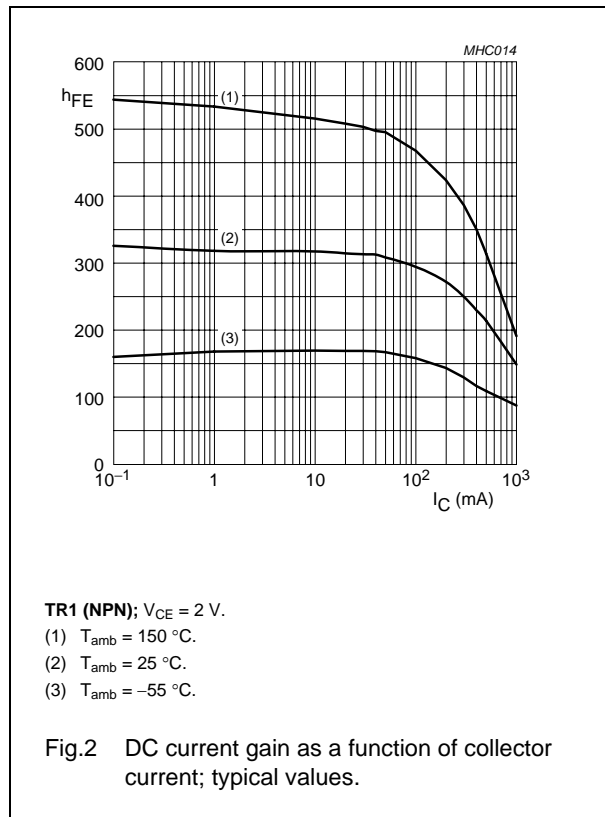

NPN/PNP general purpose transistors

PEMZ7

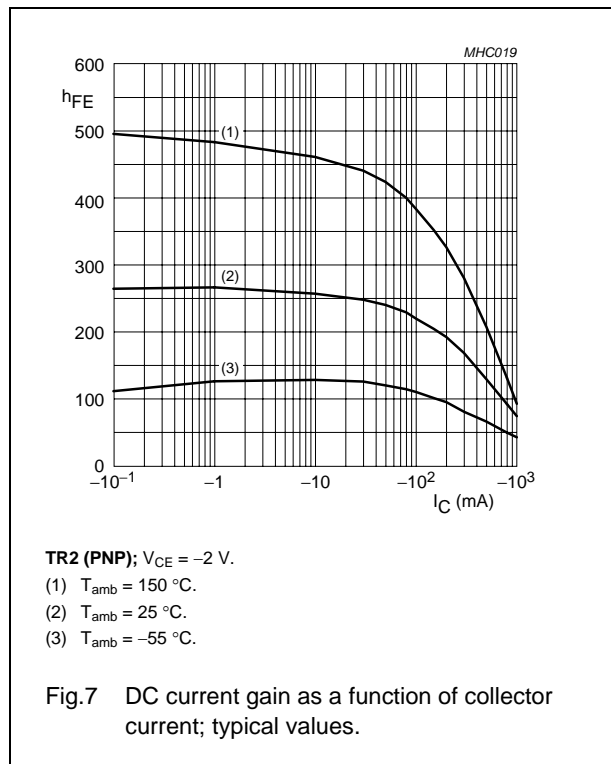
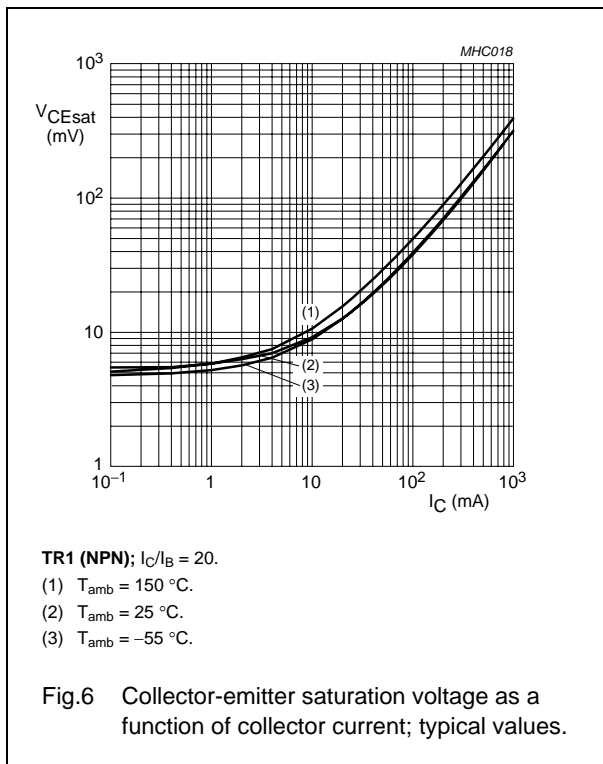
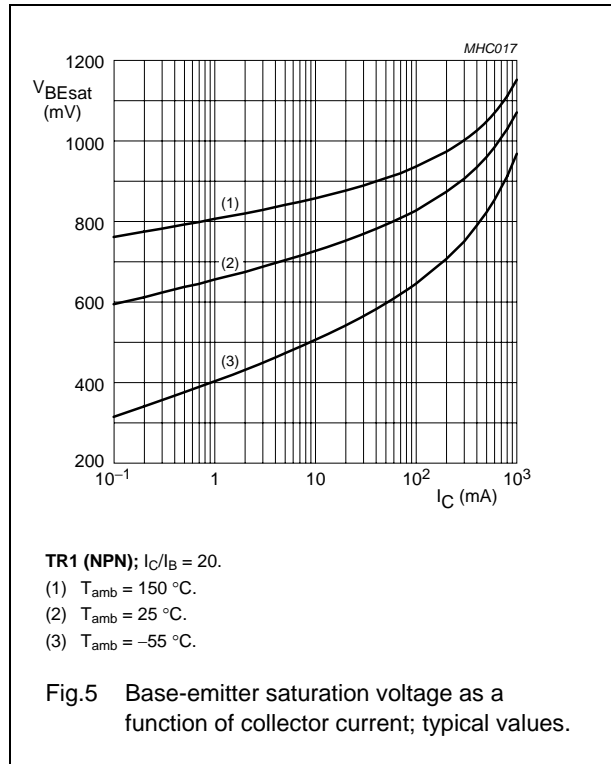
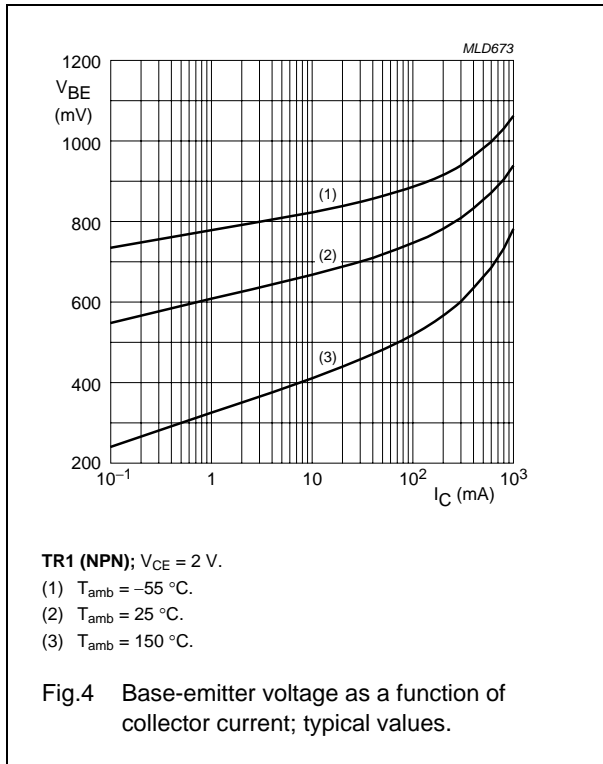

NPN/PNP general purpose transistors

PEMZ7

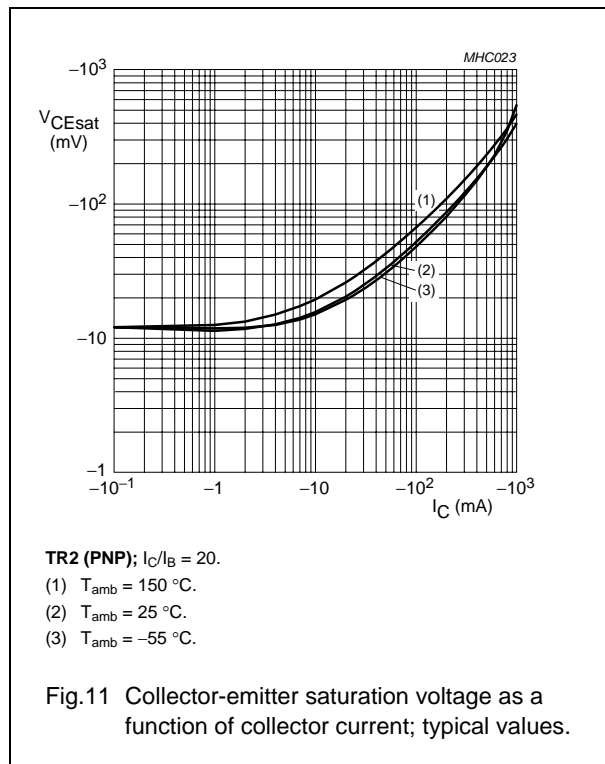
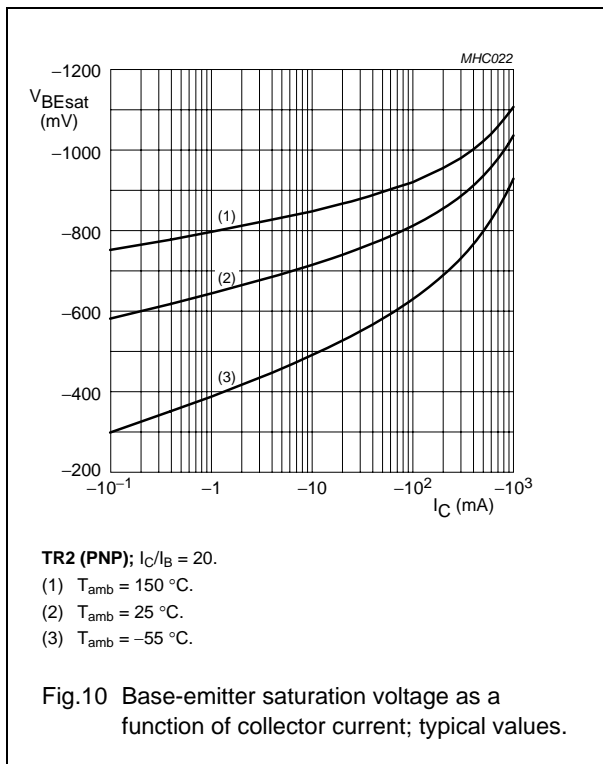
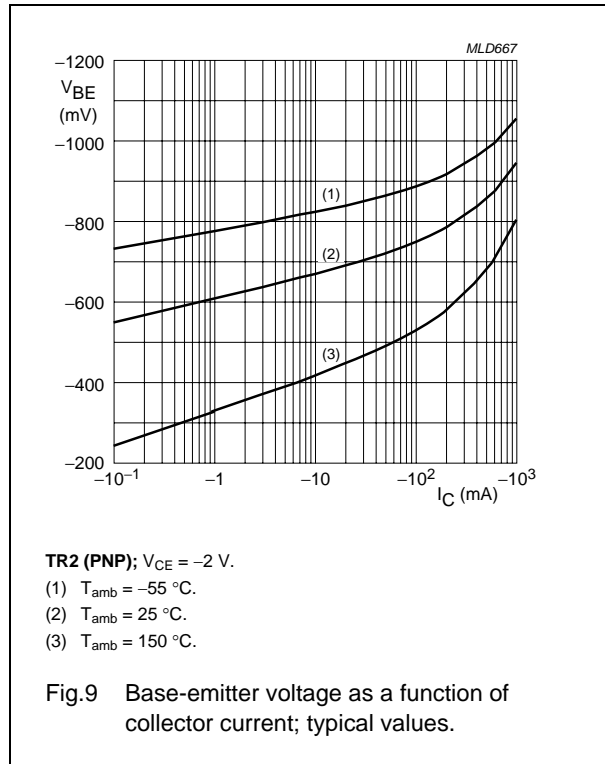
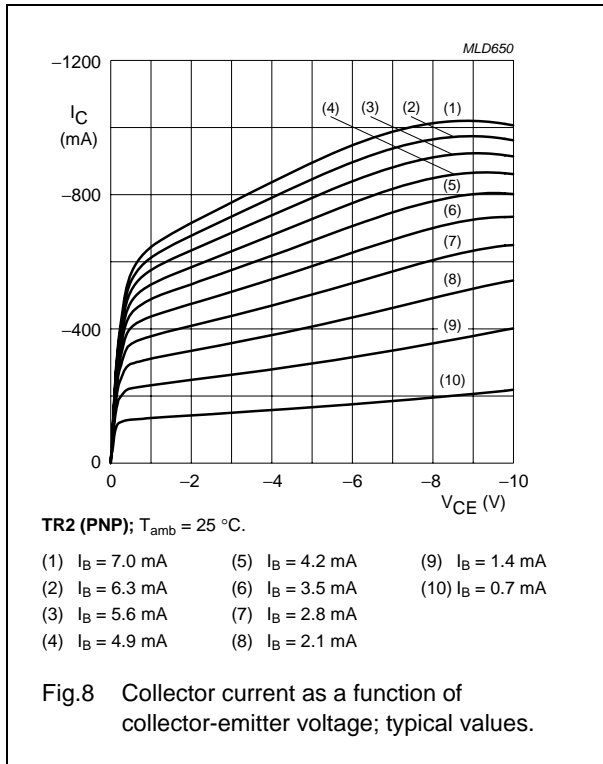

NPN/PNP general purpose transistors

PEMZ7

PACKAGE OUTLINE

Plastic surface mounted package; 6 leads

SOT666

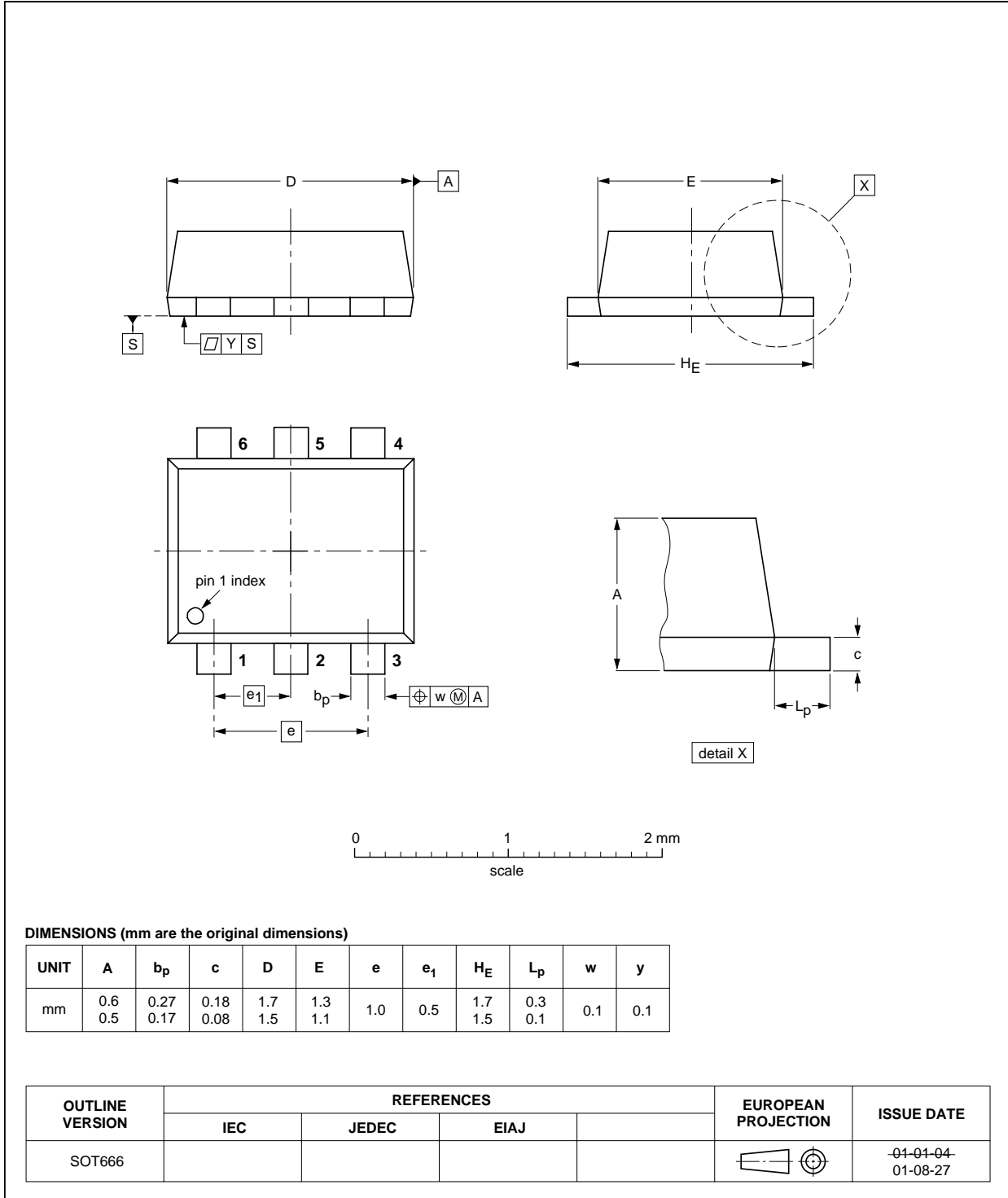

NPN/PNP general purpose transistors

PEMZ7

DATA SHEET STATUS

DOCUMENT STATUS ⁽¹⁾	PRODUCT STATUS ⁽²⁾	DEFINITION
Objective data sheet	Development	This document contains data from the objective specification for product development.
Preliminary data sheet	Qualification	This document contains data from the preliminary specification.
Product data sheet	Production	This document contains the product specification.

Notes

1. Please consult the most recently issued document before initiating or completing a design.
2. The product status of device(s) described in this document may have changed since this document was published and may differ in case of multiple devices. The latest product status information is available on the Internet at URL <http://www.nxp.com>.

DISCLAIMERS

General — Information in this document is believed to be accurate and reliable. However, NXP Semiconductors does not give any representations or warranties, expressed or implied, as to the accuracy or completeness of such information and shall have no liability for the consequences of use of such information.

Right to make changes — NXP Semiconductors reserves the right to make changes to information published in this document, including without limitation specifications and product descriptions, at any time and without notice. This document supersedes and replaces all information supplied prior to the publication hereof.

Suitability for use — NXP Semiconductors products are not designed, authorized or warranted to be suitable for use in medical, military, aircraft, space or life support equipment, nor in applications where failure or malfunction of an NXP Semiconductors product can reasonably be expected to result in personal injury, death or severe property or environmental damage. NXP Semiconductors accepts no liability for inclusion and/or use of NXP Semiconductors products in such equipment or applications and therefore such inclusion and/or use is at the customer's own risk.

Applications — Applications that are described herein for any of these products are for illustrative purposes only. NXP Semiconductors makes no representation or warranty that such applications will be suitable for the specified use without further testing or modification.

Limiting values — Stress above one or more limiting values (as defined in the Absolute Maximum Ratings System of IEC 60134) may cause permanent damage to the device. Limiting values are stress ratings only and operation of the device at these or any other conditions

above those given in the Characteristics sections of this document is not implied. Exposure to limiting values for extended periods may affect device reliability.

Terms and conditions of sale — NXP Semiconductors products are sold subject to the general terms and conditions of commercial sale, as published at <http://www.nxp.com/profile/terms>, including those pertaining to warranty, intellectual property rights infringement and limitation of liability, unless explicitly otherwise agreed to in writing by NXP Semiconductors. In case of any inconsistency or conflict between information in this document and such terms and conditions, the latter will prevail.

No offer to sell or license — Nothing in this document may be interpreted or construed as an offer to sell products that is open for acceptance or the grant, conveyance or implication of any license under any copyrights, patents or other industrial or intellectual property rights.

Export control — This document as well as the item(s) described herein may be subject to export control regulations. Export might require a prior authorization from national authorities.

Quick reference data — The Quick reference data is an extract of the product data given in the Limiting values and Characteristics sections of this document, and as such is not complete, exhaustive or legally binding.

NXP Semiconductors

Customer notification

This data sheet was changed to reflect the new company name NXP Semiconductors. No changes were made to the content, except for the legal definitions and disclaimers.

Contact information

For additional information please visit: <http://www.nxp.com>

For sales offices addresses send e-mail to: salesaddresses@nxp.com

© NXP B.V. 2009

All rights are reserved. Reproduction in whole or in part is prohibited without the prior written consent of the copyright owner.

The information presented in this document does not form part of any quotation or contract, is believed to be accurate and reliable and may be changed without notice. No liability will be accepted by the publisher for any consequence of its use. Publication thereof does not convey nor imply any license under patent- or other industrial or intellectual property rights.

Printed in The Netherlands

613514/02/pp9

Date of release: 2001 Nov 07

Document order number: 9397 750 09054

