

General Description

The MAX17502H evaluation kit (EV kit) provides a proven design to evaluate the MAX17502H high-efficiency, high-voltage, synchronous step-down DC-DC converter in a TSSOP package. The EV kit uses the device to generate 2.5V at load currents up to 1A from a 4.5V to 60V input supply. The device features a forced-PWM control scheme that provides constant switching-frequency operation at all load and line conditions.

Ordering Information appears at end of data sheet.

Component List

DESIGNATION	QTY	DESCRIPTION
C1	1	2.2µF ±10%, 100V X7R ceramic capacitor (1210) Murata GRM32ER72A225K
C2	1	1µF ±10%, 6.3V X7R ceramic capacitor (0603) Murata GRM188R70J105K
C3	1	6800pF ±10%, 25V X7R ceramic capacitor (0402) Murata GRM155R71E682K
C4	1	47µF ±10%, 6.3V X7R ceramic capacitor (1210) Murata GRM32ER70J476K
C5	1	3300pF ±10%, 50V X7R ceramic capacitor (0402) Murata GRM155R71H332K
C6	0	Not installed, ceramic capacitor (0402)
C7	1	33µF, 80V aluminum electrolytic (D = 8mm) Panasonic EEEFK1K330P
C8	0	Not installed, ceramic capacitor (1210)

Features

- Operates from a 4.5V to 60V Input Supply
- 2.5V Output Voltage
- 1A Output Current
- 300kHz Switching Frequency
- Enable/UVLO Input
- Resistor-Programmable UVLO Threshold
- Open-Drain $\overline{\text{RESET}}$ Output
- Overcurrent and Overtemperature Protection
- Proven PCB Layout
- Fully Assembled and Tested

DESIGNATION	QTY	DESCRIPTION
C9	1	47pF ±10%, 50V C0G ceramic capacitor (0402) Murata GRM1555C1H470J
JU1	1	3-pin header
L1	1	22µH, 1.7A inductor (6mm x 6mm x 3.5mm) Coilcraft LPS6235-223ML
R1	1	3.32MΩ ±1% resistor (0402)
R2	1	1MΩ ±1% resistor (0402)
R3	1	16.9kΩ ±1% resistor (0402)
R4	1	69.8kΩ ±1% resistor (0402)
R5	1	39.2kΩ ±1% resistor (0402)
R6	1	10kΩ ±1% resistor (0402)
R7	0	Not installed, resistor (0402)
TP1, TP2	0	Not installed, test points
U1	1	Buck converter (14 TSSOP) Maxim MAX17502HAUD+
—	1	Shunts
—	1	PCB: MAX17502HU EVALUATION KIT

Component Suppliers

SUPPLIER	PHONE	WEBSITE
Coilcraft, Inc.	847-639-6400	www.coilcraft.com
Murata Electronics North America, Inc.	770-436-1300	www.murata-northamerica.com
Panasonic Corp.	800-344-2112	www.panasonic.com

Note: Indicate that you are using the MAX17502 when contacting these component suppliers.

Quick Start

Recommended Equipment

- MAX17502H EV kit
- 4.5V to 60V, 2A DC input power supply
- Load capable of sinking 1A
- Function generator
- Digital voltmeter (DVM)

Procedure

The EV kit is fully assembled and tested. Follow the steps below to verify the board operation. **Caution: Do not turn on power supply until all connections are completed.**

- 1) Set the power supply at a voltage between 4.5V and 60V. Disable the power supply.
- 2) Connect the positive terminal of the power supply to the VIN PCB pad and the negative terminal to the nearest PGND PCB pad. Connect the positive terminal of the 1A load to the VOUT PCB pad and the negative terminal to the nearest PGND PCB pad.
- 3) Connect the DVM across the VOUT PCB pad and the nearest PGND PCB pad.
- 4) Verify that a shunt is installed across pins 1-2 on jumper JU1.
- 5) Turn on the DC power supply.
- 6) Enable the load.
- 7) Verify that the DVM displays the expected voltage.

To turn-on/off the part from EN/UVLO, follow the steps below:

- 1) Remove resistors R1 and R2 and the jumper connected across pins 1-2 on jumper JU1.
- 2) Connect the power supply to the EV kit and turn on the power supply. Set the power supply at a voltage between 4.5V and 60V.

- 3) Connect the function generator output to the EN/UVLO test loop.
- 4) The EN/UVLO rising threshold is 1.24V and falling threshold is 1.11V, so make sure that the voltage high and voltage low levels of the function generator output are greater than 1.24V and less than 1.11V, respectively.
- 5) While powering down the EV kit, first disconnect the function generator output from the EN/UVLO test loop and then turn off the DC power supply.

Detailed Description

The MAX17502H EV kit provides a proven design to evaluate the MAX17502H high-efficiency, high-voltage, synchronous step-down DC-DC converter in a TSSOP package. The EV kit generates 2.5V at load currents up to 1A from a 4.5V to 60V input supply. The EV kit features a 300kHz fixed switching frequency for optimum efficiency and component size. The device features a forced-PWM control scheme that provides constant switching-frequency operation at all load and line conditions.

The EV kit includes an EN/UVLO PCB pad to enable control of the converter output. An additional $\overline{\text{RESET}}$ PCB pad is available for monitoring the converter output. The VCC PCB pad helps measure the internal LDO voltage.

Soft-Start Input (SS)

The device utilizes an adjustable soft-start function to limit inrush current during startup. The soft-start time is adjusted by the value of C3, the external capacitor from SS to GND. To adjust the soft-start time, determine C3 using the following formula:

$$C3 = 5.55 \times t_{SS}$$

where t_{SS} is the required soft-start time in milliseconds and C3 is in nanofarads.

Table 1. Regulator Enable (EN/UVLO) Jumper JU1 Description

SHUNT POSITION	EN/UVLO PIN	MAX17502_ OUTPUT
1-2*	Connected to V_{IN}	Enabled
Not installed	Connected to center node of resistor-divider R1 and R2	Enabled, UVLO level set through R1 and R2 divider
2-3	Connected to GND	Disabled

*Default position.

Regulator Enable/Undervoltage Lockout Level (EN/UVLO)

The device features an EN/UVLO input. For normal operation, a shunt should be installed across pins 1-2 on jumper JU1. To disable the output, install a shunt across pins 2-3 on JU1 and the EN/UVLO pin is pulled to GND. See Table 1 for JU1 settings.

Setting the Undervoltage-Lockout Level

The device offers an adjustable input undervoltage-lockout level. Set the voltage at which the device turns on with a resistive voltage-divider connected from V_{IN} to GND (see Figure 1). Connect the center node of the divider to EN/UVLO.

Choose R1 to be $3.3M\Omega$ and then calculate R2 as follows:

$$R2 = \frac{R1 \times 1.218}{(V_{INU} - 1.218)}$$

where V_{INU} is the voltage at which the device is required to turn on. Ensure that V_{INU} is higher than $0.8 \times V_{OUT}$.

Adjusting Output Voltage

The device offers an adjustable output voltage. Set the output voltage with a resistive voltage-divider connected from the positive terminal of the output capacitor (V_{OUT}) to GND (see Figure 6). Connect the center node of the divider to FB/VO.

To choose the values of R4 and R5, select the parallel combination of R4 and R5, R_p to be less than $30k\Omega$. Once R_p is selected, calculate R4 as follows:

$$R4 = \frac{R_p \times V_{OUT}}{0.9}$$

Calculate R5 as follows:

$$R5 = \frac{R4 \times 0.9}{(V_{OUT} - 0.9)}$$

EV Kit Performance Report

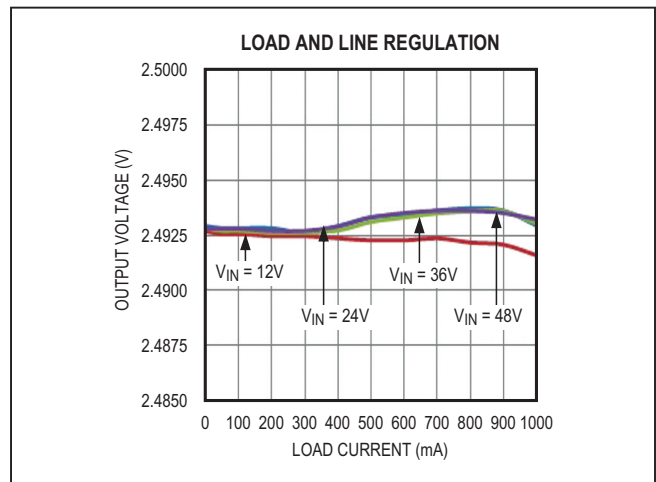

Figure 1. MAX17502H Load and Line Regulation

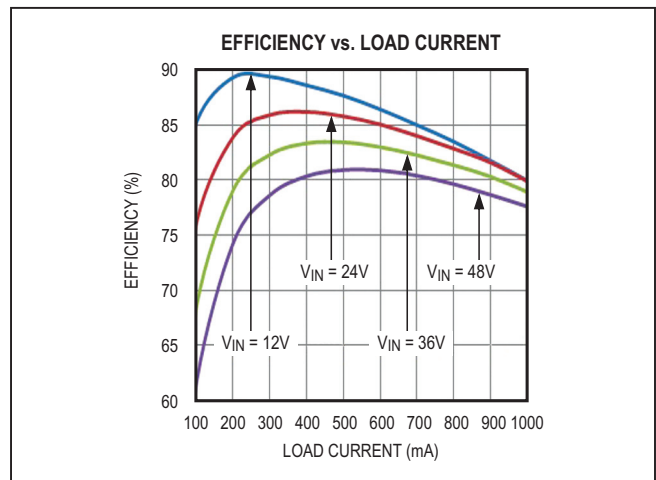

Figure 2. MAX17502H Efficiency

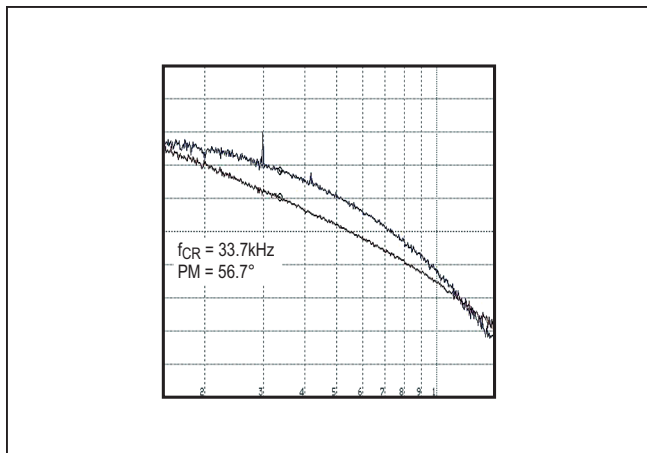

Figure 3. MAX17502H Full Load Bode Plot ($V_{IN} = 24V$)

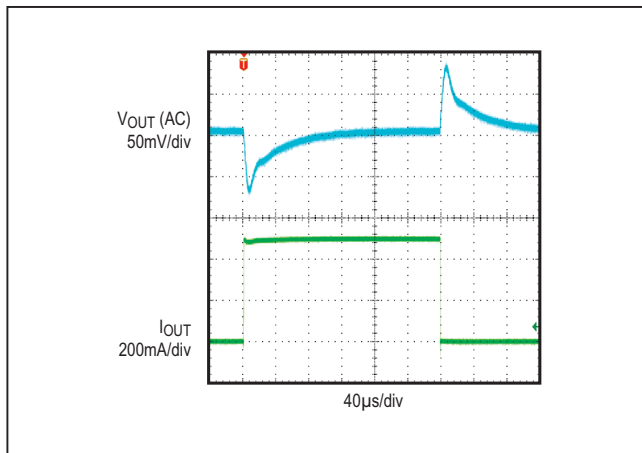

Figure 4. MAX17502H No Load to 500mA Load Transient

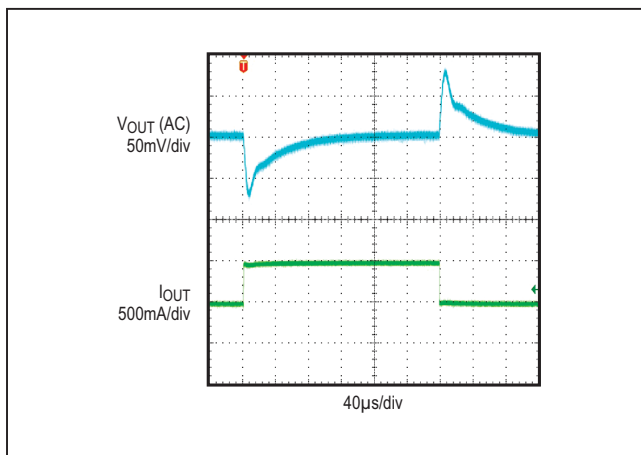

Figure 5. MAX17502H 500mA to 1A Load Transient

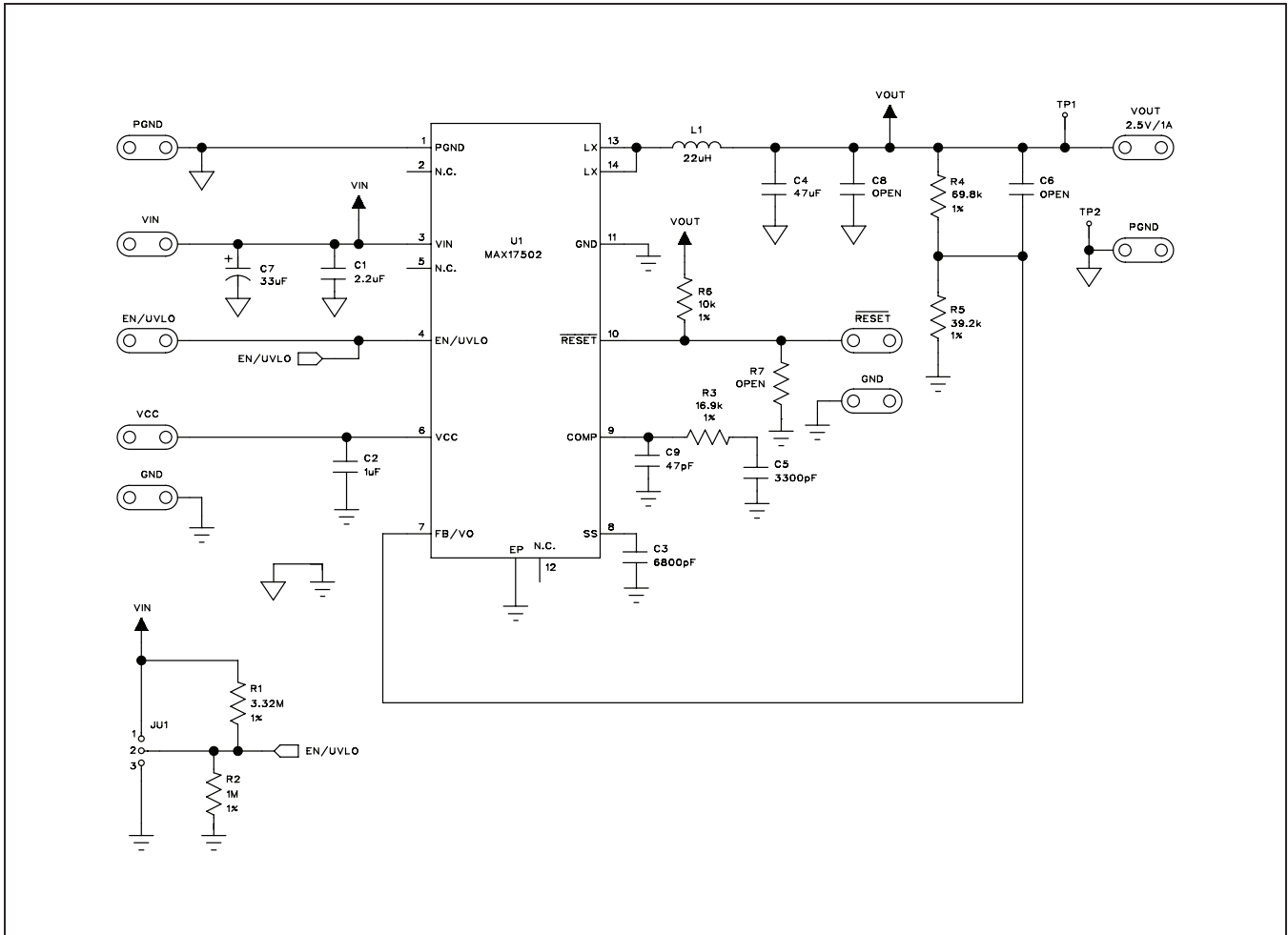

Figure 6. MAX17502H EV Kit Schematic

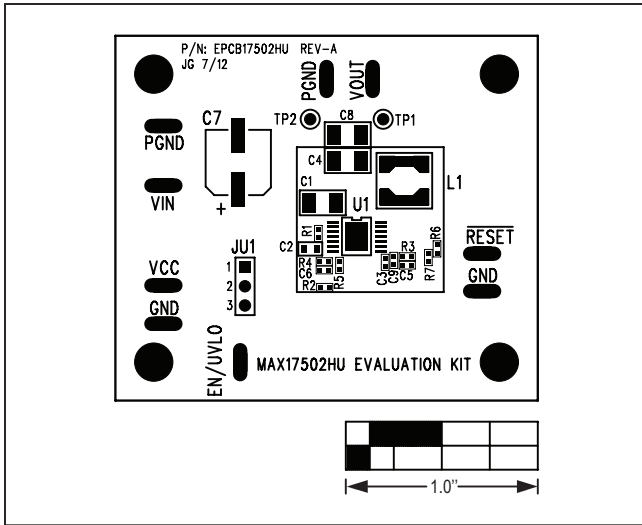

Figure 7. MAX17502H EV Kit Component Placement Guide—Component Side

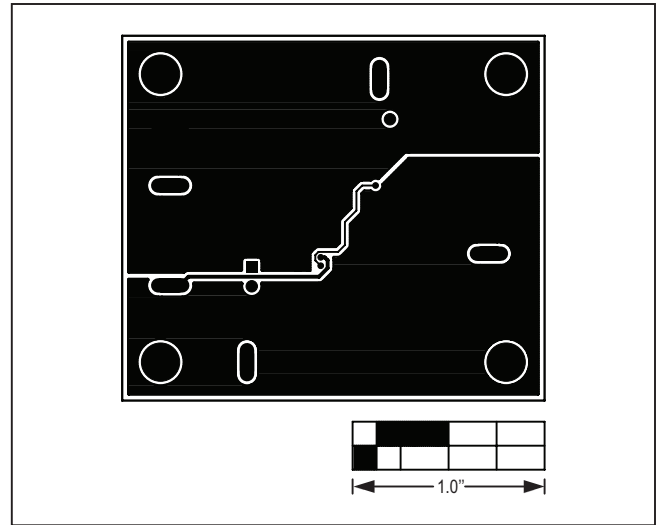

Figure 9. MAX17502HU EV Kit PCB Layout—Solder Side

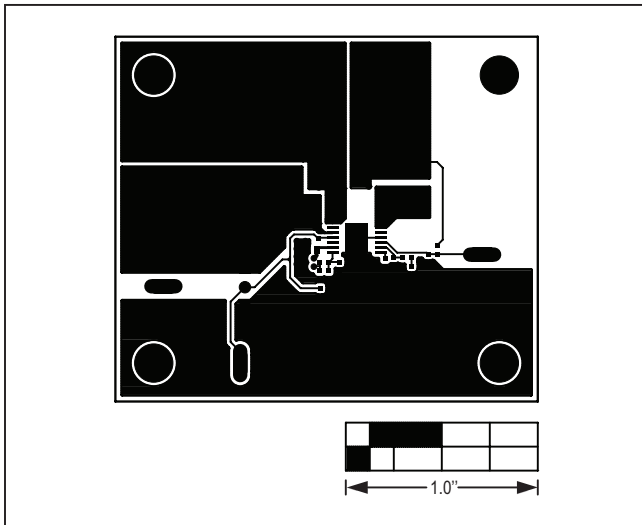

Figure 8. MAX17502H EV PCB Layout—Component Side

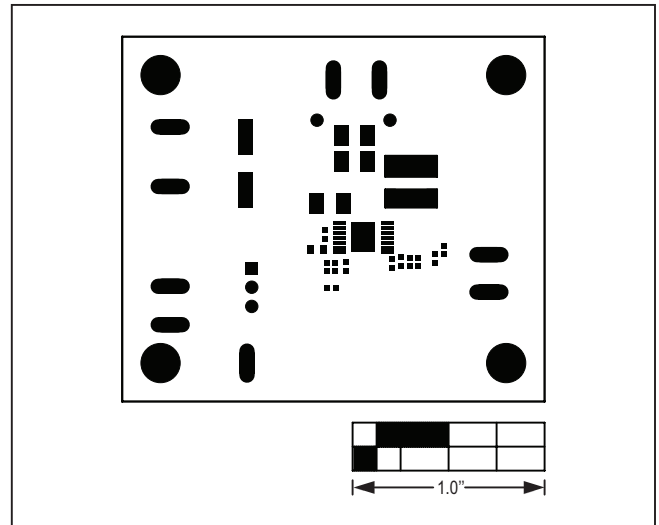

Figure 10. MAX17502HU EV Kit PCB Layout—Top Solder Mask

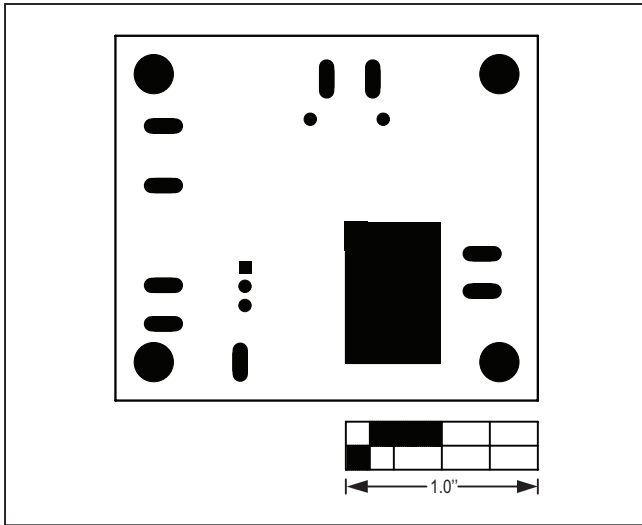

Figure 11. MAX17502HU EV Kit PCB Layout—Bottom Solder Mask

Ordering Information

PART	TYPE
MAX17502HUEVKIT#	EV Kit

#Denotes RoHS compliant.

Revision History

REVISION NUMBER	REVISION DATE	DESCRIPTION	PAGES CHANGED
0	11/12	Initial release	—

For pricing, delivery, and ordering information, please contact Maxim Direct at 1-888-629-4642, or visit Maxim Integrated's website at www.maximintegrated.com.

Maxim Integrated cannot assume responsibility for use of any circuitry other than circuitry entirely embodied in a Maxim Integrated product. No circuit patent licenses are implied. Maxim Integrated reserves the right to change the circuitry and specifications without notice at any time.