

User Guide for
FEBFAN6863W_CP452v1
Evaluation Board

Highly Integrated Green-Mode PWM
Controller FAN6863W
19 V / 2.1 A Notebook Adapter

Featured Fairchild Product:
FAN6863W

***Direct questions or comments
about this evaluation board to:
“Worldwide Direct Support”***

Fairchild Semiconductor.com

Table of Contents

1. Introduction.....	4
1.1. Description	4
1.2. Features	4
2. Evaluation Board Specifications.....	5
3. Photographs.....	6
4. Printed Circuit Board	7
5. Schematic.....	8
6. Bill of Materials	9
7. Test Conditions & Test Equipment.....	10
8. Input Current.....	11
8.1. Test Condition	11
9. Input Wattage at No-load Condition.....	11
9.1. Test Condition	11
9.2. Measured Waveforms	11
10. Turn-On Time	12
10.1. Test Condition	12
11. Hold-up Time.....	12
11.1. Test Condition	12
11.2. Measured Waveform	12
12. DC Output Rising Time	13
12.1. Test Condition	13
12.2. Measured Waveform	13
13. Line & Load Regulation	14
13.1. Test Condition	14
14. Efficiency	14
14.1. Test Condition	14
15. Output Ripple & Noise	16
15.1. Test Condition	16
15.2. Measured Waveform	16
16. Step Response	17
16.1. Test Condition	17
16.2. Measured Waveform	17

17. Over-Current Protection (OCP)	18
17.1. Test Condition	18
18. Short-Circuit Protection	18
18.1. Test Condition	18
18.2. Measured Waveform (Output-Short Condition)	18
19. Brownout Test	19
19.1. Test Condition	19
20. V_{DD} Voltage Level	19
20.1. Measured Waveform	19
21. Voltage Stress on MOSFET & Rectifiers	20
21.1. Test Condition	20
21.2. Measured Waveform	20
21.3. Electromagnetic Interference (EMI) Test	21
22. Surge Test	22
23. ESD Test	22
24. Revision History	28

This user guide supports the evaluation kit for the FAN6863W. This FEBFAN6863W_CP452v1 evaluation board can be identified by the silkscreen marking PLM0068 REV:1 on the bottom side of the PCB. It should be used in conjunction with the FAN6863W datasheet as well as Fairchild's application notes and technical support team. Please visit Fairchild's website at www.fairchildsemi.com.

1. Introduction

This document describes a 40 W power supply using the FAN6863W.

1.1. Description

The operating current in FAN6863W is as small as 3 mA. The small operating current results in higher efficiency and reduces the V_{DD} hold-up capacitance requirement. Once FAN6863W enter “deep” Green Mode, the operating current is reduced to 0.6 mA, assisting the power supply in meeting power conservation requirements.

By using FAN6863W, an adapter can be implemented with few external components and minimized cost.

1.2. Features

- Low Standby Power: Under 0.1 W
- Low Startup Current: 8 μ A
- Low Operating Current in Green Mode: 600 μ A
- Peak-Current Mode Operation with Cycle-by-Cycle Current Limiting
- PWM Frequency Continuously Decreasing with Burst Mode at Light Loads
- V_{DD} Over-Voltage Protection (OVP)
- Constant Output Power Limit (Full AC Input Range)
- Internal Latch Circuit (FAN6863WL) for OVP, OTP
- SENSE Pin Short-Circuit Protection (SSCP)
- Fixed PWM Frequency (65 KHz) with Frequency Hopping
- Feedback Open-Loop Protection: 60 ms Delay
- GATE Output Maximum Voltage Clamp: 13.5 V
- Soft-Start Time: 5 ms
- Soft Driving for EMI Improvement
- Full-Range Frequency Hopping
- Internal OTP Sensor with Hysteresis
- Gate Driving Capability: 400 mA

2. Evaluation Board Specifications

Table 1. Summary of Features and Performance

All result is tested with output DC cable, AWG 18, 1.8 M.

Specification	Min.	Max.	Unit
Input			
Voltage	90	264	V _{AC}
Frequency	47	63	Hz
Output			
Output Voltage 1		19	V
Output Current 1	0	2.1	A
Total Output Power			
Full-load Output Power	0	40	W

3. Photographs



Figure 1. Top View



Figure 2. Bottom View

4. Printed Circuit Board

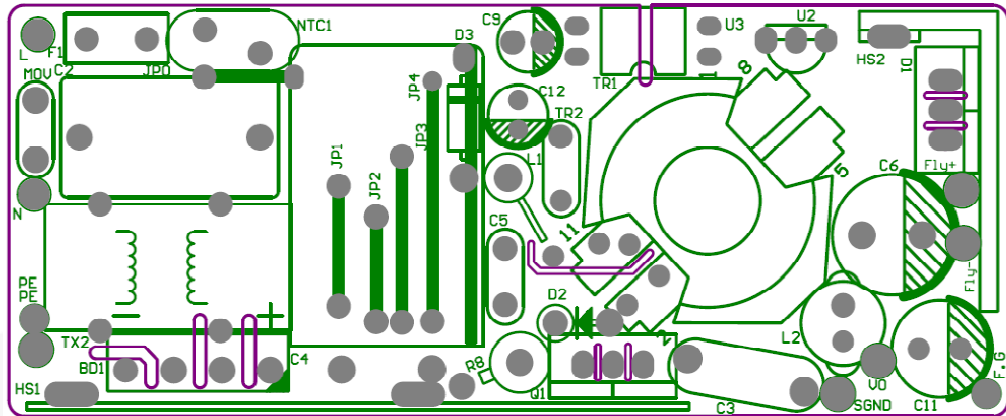

Figure 3. Top Overlay

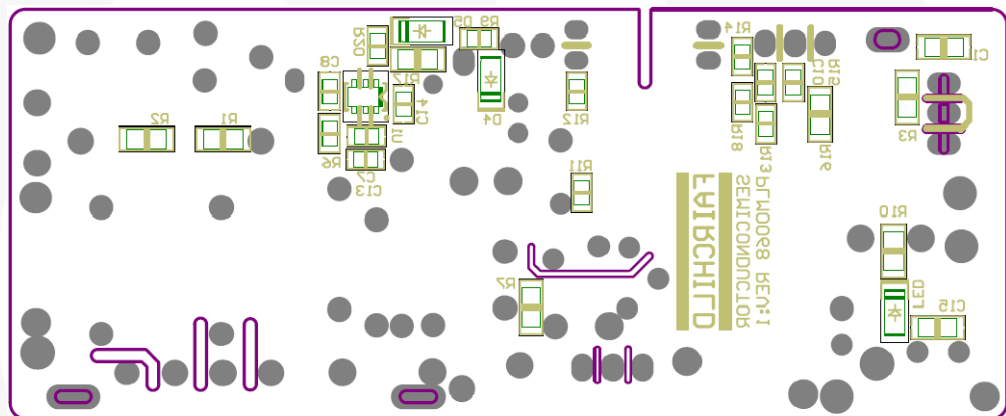

Figure 4. Bottom Overlay

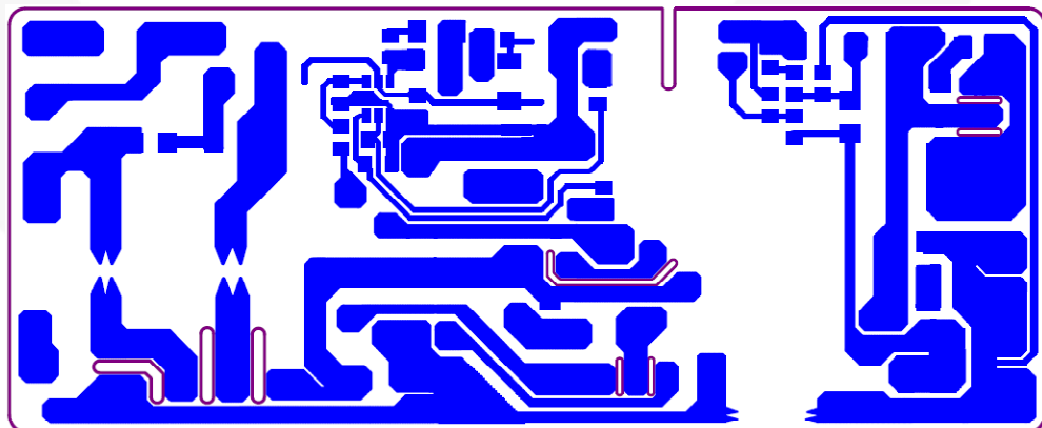

Figure 5. Bottom Layer

5. Schematic

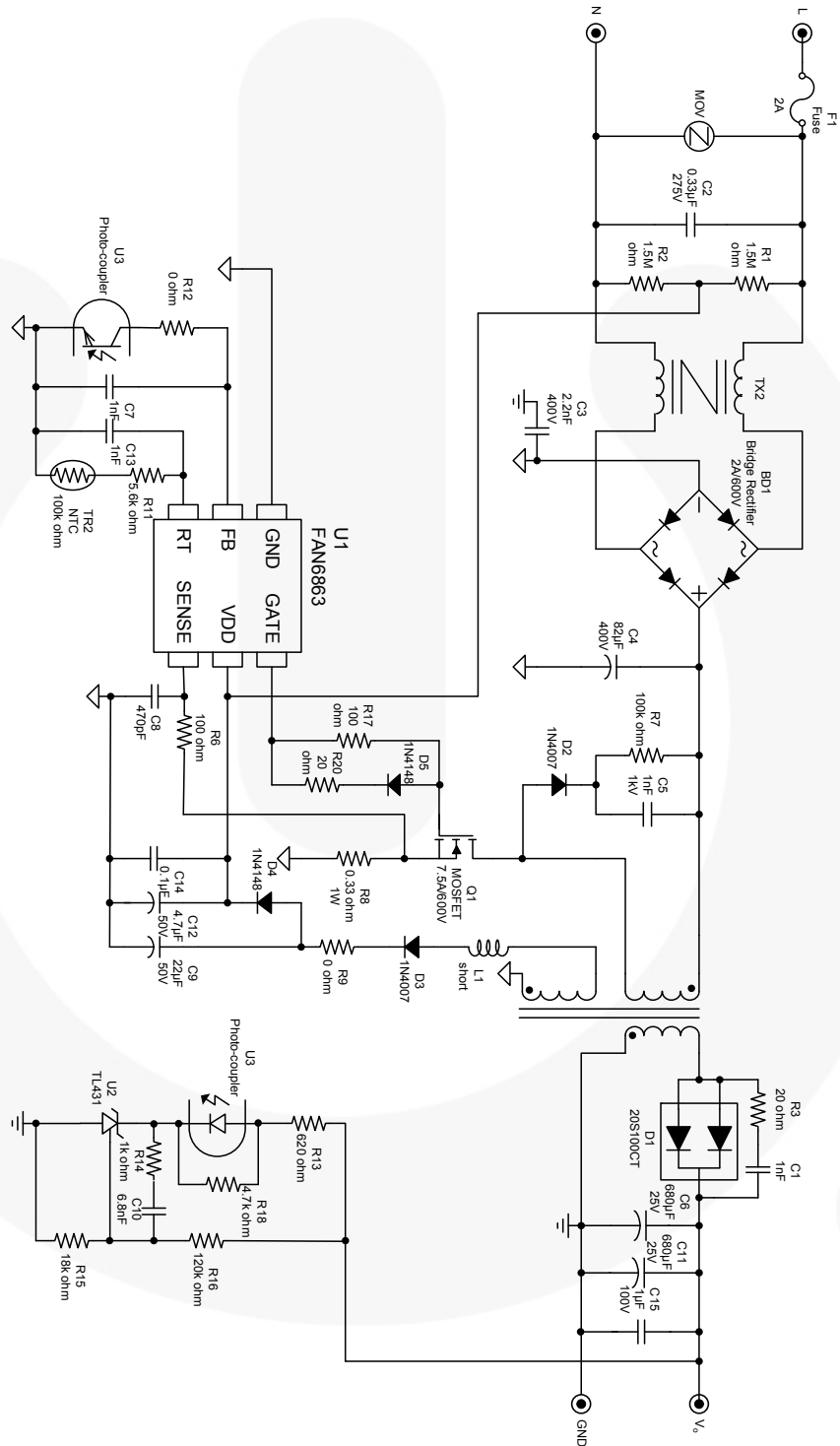

Figure 6. Evaluation Board Schematic

6. Bill of Materials

Part Type	Qty.	Part No.	Manufacturer	Designator
JUMPER WIRE 0.8ψ(mm)	8			JP0~JP4, NTC1, L1, L2
Metal-Oxide Resistor 1 W 0.33 Ω ±10%	1			R8
SMD Resistor 0805 0 Ω ±%	1			R9, R12
SMD Resistor 0805 20 Ω ±5%	1			R20
SMD Resistor 0805 100 Ω ±5%	2			R6
SMD Resistor 0805 620 Ω ±5%	1			R13
SMD Resistor 0805 1 kΩ ±5%	1			R14
SMD Resistor 0805 5.6 kΩ ±5%	1			R11
SMD Resistor 0805 18 kΩ ±5%	1			R15
SMD Resistor 0805 47 kΩ ±5%	1			R18
SMD Resistor 1206 20 Ω ±5%	1			R3
SMD Resistor 1206 100 Ω ±5%	1			R17
SMD Resistor 1206 100 kΩ ±5%	1			R7
SMD Resistor 1206 120 kΩ ±5%	1			R16
SMD Resistor 1206 1.5 MΩ ±5%	2			R1, R2
0805 X7R +/-10% 1 nF 50 V	2			C7, C13
0805 X7R +/-10% 470 pF 50 V	1			C8
0805 X7R +/-10% 6.8 nF 50 V	1			C10
0805 X7R +/-10% 0.1 μF 50 V	1			C14
1206 X7R +/-10% 1 nF 100 V	1			C1
1206 X7R +/-10% 1 μF 100 V	1			C15
Ceramic Capacitor 1 nF 1K V	1			C5
Electrolytic Capacitor 82 μF 400 V 105°C	1	KMG	NCC	C4
Electrolytic Capacitor 680 μF 25 V 105°C	1	KY	NCC	C6
Electrolytic Capacitor 22 μF 50 V 105°C	1	LHK	Jackcon	C9
Electrolytic Capacitor 680 μF 25 V 105°C	1	LHK	Jackcon	C11
Electrolytic Capacitor 4.7 μF 50 V 105°C	1	LHK	Jackcon	C12
X2 Capacitor 0.33 μF 275 V ±10%	1			C2
Y1 Capacitor 2.2 nF 250 V ±20%	1			C3
MOV Oxide Varistor 471	1			MOV
Common choke 30 mH ±10%	1	TRN0279	SEN HUEI	TX2
Transformer RM-8 L=920 μH	1	TRN0280	SEN HUEI	TR1
FUSE MICRO RST 250 V / 2 A Time-Lag	1		Walter	F1
NTC Resistor 100 kΩ	1	TTC104	Thinking	TR2
SMD Diode 1 A / 1000 V SOD-80	2	LL4148	Fairchild Semiconductor	D4, D5
Diode 1A/700V DO-41	2	1N4007	Fairchild Semiconductor	D2, D3
Bridge Rectifier 2 A / 600 V	1	2KBP06M	Fairchild Semiconductor	BD1
Schottky Diode 20 A / 100 V TO-220	1	YM20S100CT	Fairchild Semiconductor	D1
MOSFET 7.5 A/600 V TO-220	1	FQP8N60C	Fairchild Semiconductor	Q1
REGULATOR ±% TO-92	1	FAN431ACZ-AP	Fairchild Semiconductor	U2
Photo Coupler DIP	1	FOD817A	Fairchild Semiconductor	U3
PWM Controller SSOT-6	1	FAN6863W	Fairchild Semiconductor	U1
Heat Sink 55X20X1.5 mm	1	MCH0636		HS1
Heat Sink 11.5X24.9(L)X17(H)X1.5(W) mm	1	MCH0637		HS2
PCB PLM0068 REV0	1			

7. Test Conditions & Test Equipment

Table 2. Test Conditions & Test Equipment

Test Temperature	Ambient
Test Equipment	AC Source: 6810 AC POWER SOURCE (MG-0010) Electronic Load: Chroma 63102 (MG-0081) Power Meter: BM817 (MG-0011) Oscilloscope: LeCory 423 (MG-0008)
Test Items	<ol style="list-style-type: none"> 1. Input Current 2. Input Wattage at No Load Condition 3. Turn On Time 4. Hold Up Time 5. DC Output Rising Time 6. Line & Load Regulation 7. Efficiency 8. Output Ripple & Noise 9. Step Response 10. Over-Current Protection 11. Short-Circuit Protection 12. Brownout Test 13. V_{DD} Voltage Level 14. Voltage Stress on MOSFET & Rectifiers 15. EMI Test

8. Input Current

8.1. Test Condition

Measure the AC input current at maximum loading.

Table 3. Test Result

Input Voltage	Input Current (mA)
90 V / 60 Hz	824
264 V / 50 Hz	359

9. Input Wattage at No-load Condition

9.1. Test Condition

Measure the input wattage and output voltage at no load.

Table 4. Test Result

Input Voltage	Input Wattage (mW)	Output Voltage(V)	Specification
90 V / 60Hz	34	19.28	<0.3W
115 V / 60 Hz	37	19.28	
230 V / 50 Hz	68	19.28	
264 V / 50 Hz	81	19.28	
90 V / 60 Hz	34	19.28	

9.2. Measured Waveforms

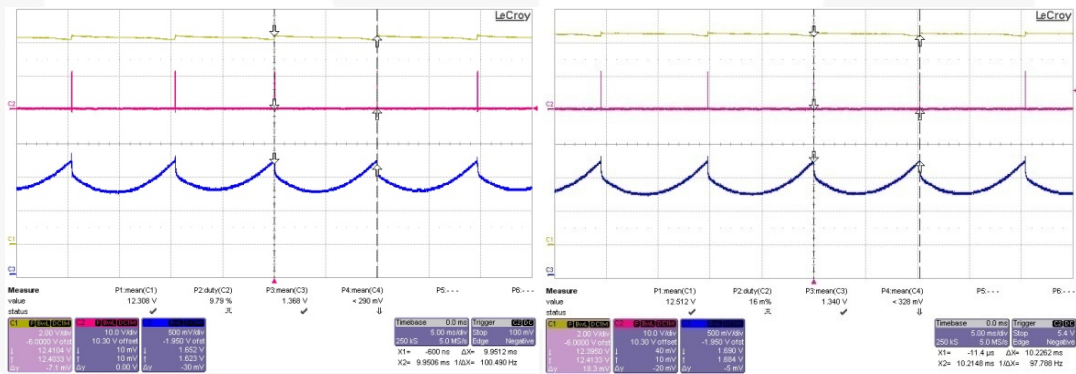

Figure 7. 90 V / 60 Hz at No Load, Ch1: V_{DD}, Ch2: V_{GATE}, Ch3: FB

Figure 8. 264 V / 50 Hz at No Load, Ch1: V_{DD}, Ch2: V_{GATE}, Ch3: FB

10. Turn-On Time

10.1. Test Condition

Set the output at maximum loading. Measure the interval between the AC plug-in and stable output.

Table 5. Test Result

Input Voltage	Turn On Time (s)	Specification
90 V / 60 Hz	1.56	<3 s
264 V / 50 Hz	0.465	

11. Hold-up Time

11.1. Test Condition

Set the output at maximum load. Measure the time interval between the AC power-off and output voltage falling to the lower limit of rated value. The AC waveform should be off at zero degrees.

Table 6. Test Result

Input Voltage	Hold-up Time (ms)
90 V / 60 Hz	7.7
115 V / 60 Hz	15.1
230 V / 50 Hz	83.9
264 V / 50 Hz	115.2

11.2. Measured Waveform

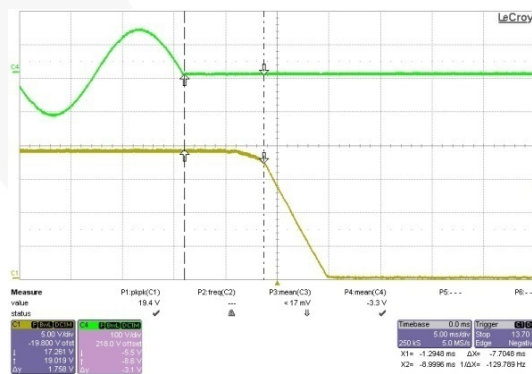

Figure 9. 90 V / 60 Hz at Maximum Load, Ch1: V_{AC}, Ch4: V_O

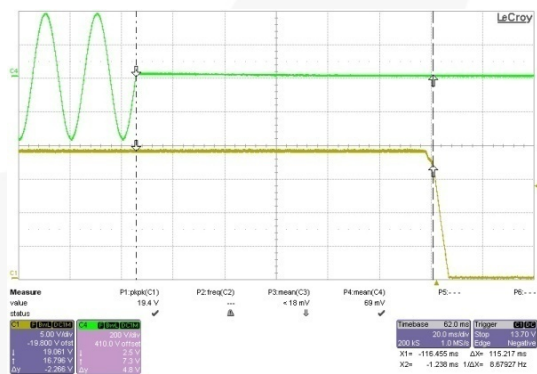

Figure 10. 264 V / 50 Hz at Maximum Load, Ch1: V_{AC}, Ch4: V_O

12. DC Output Rising Time

12.1. Test Condition

Set the output at maximum loading and no loading. Measure the time interval between 10% to 90% of the output during startup.

Table 7. Test Result

Input Voltage	Maximum Load (ms)	No Load (ms)	Specification
90 V / 60 Hz	5.18	4.25	< 20 ms
264 V / 50 Hz	4.28	3.49	

12.2. Measured Waveform

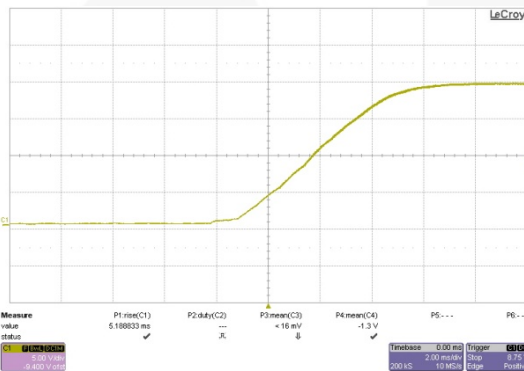

Figure 11. 90 V / 60 Hz at Maximum Load, Ch1: V_O

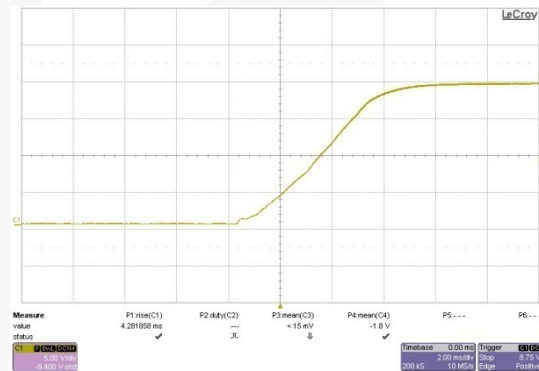

Figure 12. 264 V / 50 Hz at Maximum Load, Ch1: V_O

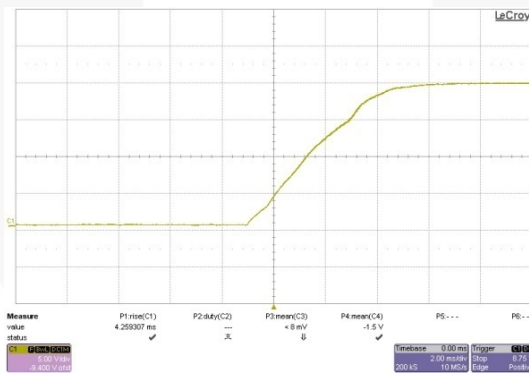

Figure 13. 90 V / 60 Hz at No Load, Ch1: V_O

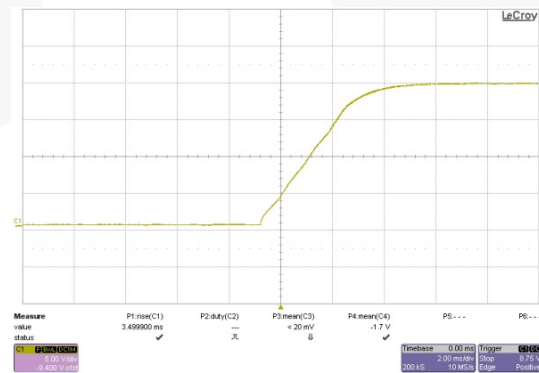

Figure 14. 264 V / 50 Hz at No Load, Ch4: V_O

13. Line & Load Regulation

13.1. Test Condition

Measure line and load regulation according to Table 8.

Table 8. Test Result

Input Voltage	Output Voltage at Max. Load (V)	Output Voltage at Min. Load(V)	Load Regulation (%)	Specification
90 V / 60 Hz	19.106	19.28	0.90	5%
115 V / 60 Hz	19.100	19.28	0.90	
132 V / 60 Hz	19.090	19.27	0.90	
180 V / 50 Hz	19.090	19.27	0.90	
230 V / 50 Hz	19.088	19.27	0.90	
264 V / 50 Hz	19.080	19.27	0.90	
Line Regulation	0.13%	0.05%		

14. Efficiency

14.1. Test Condition

Output at maximum load.

Table 9. Test Result

Input Voltage	Input Wattage (W)	Output Wattage (W)	Efficiency (%)	Specification
90 V / 60 Hz	45.32	39.98	88.20	
115 V / 60 Hz	44.69	39.96	89.40	
132 V / 60 Hz	44.50	39.91	89.60	
180 V / 50 Hz	44.31	39.91	90.06	
230 V / 50 Hz	44.26	39.91	90.10	
264 V / 50 Hz	44.56	39.92	89.58	

Table 10. Test Result

Input Voltage	Efficiency (%)					Specification
	25% Load	50% Load	75% Load	100% Load	Avg.	
115 V / 60 Hz	89.4	90.0	89.5	89.4	89.5	
230 V / 50 Hz	89.4	89.6	90.3	90.2	89.8	

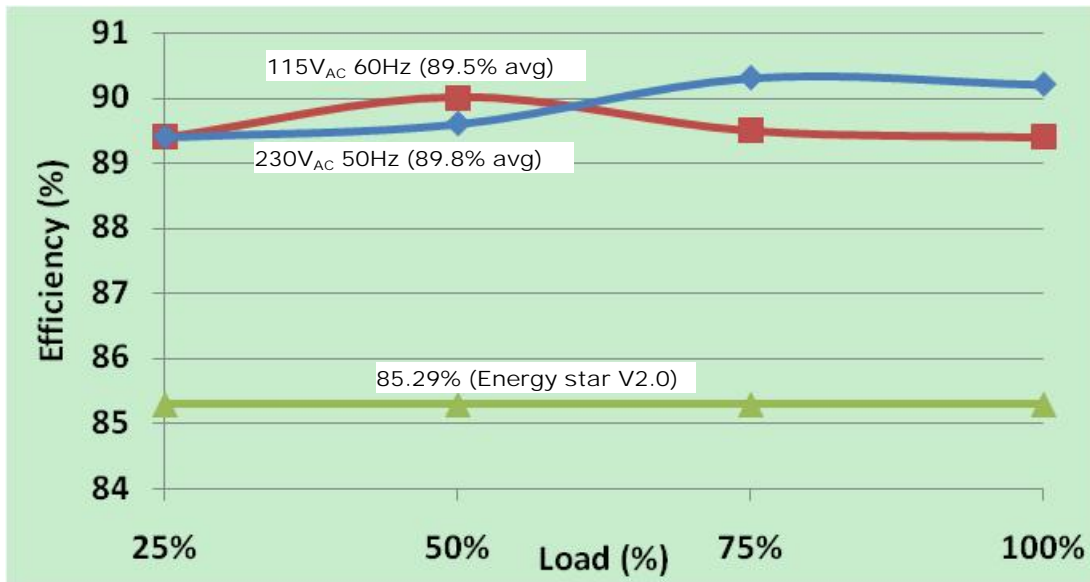

Figure 15. Efficiency at Various Loads

15. Output Ripple & Noise

15.1. Test Condition

Ripple and noise are measured by using a 20 MHz bandwidth-limited oscilloscope with a 10 μ F capacitor paralleled with a high-frequency 0.1 μ F capacitor across each output.

Table 11. Test Result

Input Voltage	Maximum Load (mV)	Minimum Load (mV)
90 V / 60 Hz	286	117
115 V / 60 Hz	264	125
230 V / 50 Hz	255	150
264 V / 50 Hz	248	160

15.2. Measured Waveform

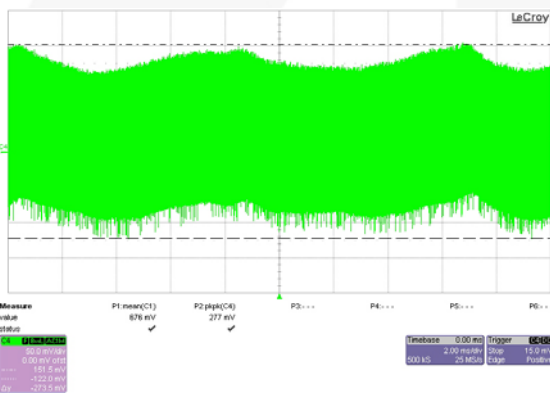

Figure 16. 90 V / 60 Hz at Maximum Load, Ch4: V_O

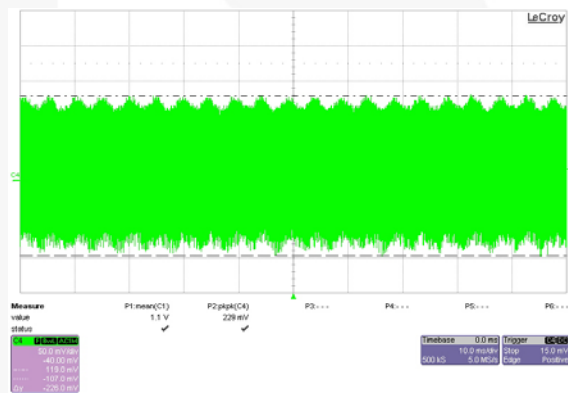

Figure 17. 264 V / 50 Hz at Maximum Load, Ch4: V_O

16. Step Response

16.1. Test Condition

Dynamic loading (20%~80% of the full load, 5 ms duty cycle, 2.5 A/ μ s rise / fall time).

Table 12. Test Result

Input Voltage	Overshoot (mV)	Undershoot (mV)
115 V / 60 Hz	217	152
230 V / 50 Hz	276	159

16.2. Measured Waveform

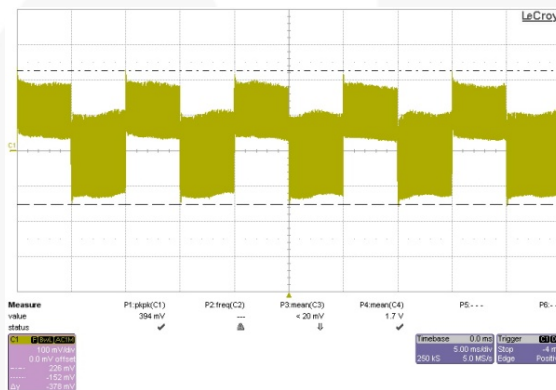

Figure 18. 115 V / 60 Hz at Maximum Load, Ch1: V_O

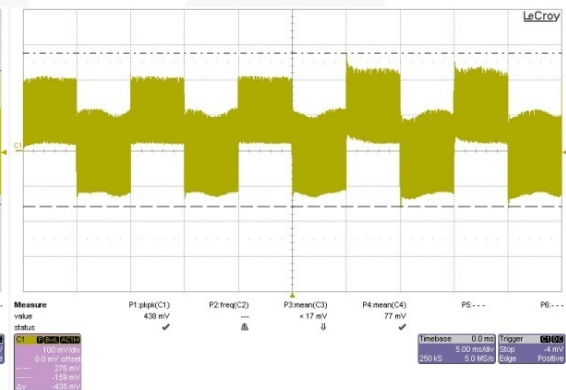

Figure 19. 264 V / 50 Hz at Maximum Load, Ch1: V_O

17. Over-Current Protection (OCP)

17.1. Test Condition

Increase output loading gradually. Measure the output maximum current.

Table 13. Test Result

Input Voltage	Maximum Load (ms)
90 V / 60 Hz	2.94
115 V / 60 Hz	3.27
230 V / 50 Hz	3.39
264 V / 50 Hz	3.37

18. Short-Circuit Protection

18.1. Test Condition

Short the output of the power supply. The power supply should enter “Hiccup” Mode protection with less than 2 W input voltage.

Table 14. Test Result

Input Voltage	Input Wattage at Maximum Loading (W)	Input Wattage at Minimum Loading (W)	Specification
90 V / 60 Hz	0.15	0.15	<2 W
264 V / 50 Hz	0.35	0.34	

18.2. Measured Waveform (Output-Short Condition)

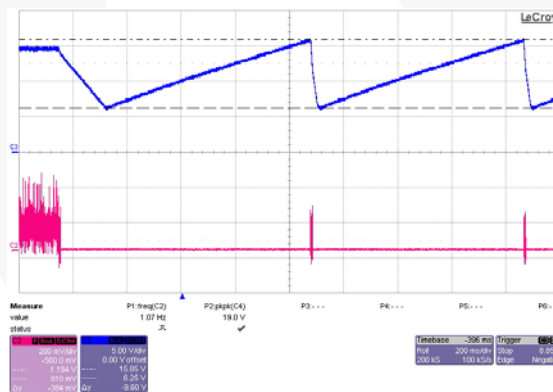

Figure 20. 90 V / 60 Hz at Maximum Load, Ch2: V_{CS}, Ch3: V_{DD}

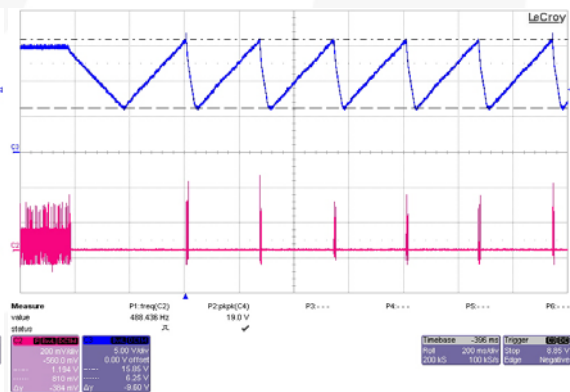

Figure 21. 264 V / 50 Hz at Maximum Load, Ch2: V_{CS}, Ch3: V_{DD}

19. Brownout Test

19.1. Test Condition

Set the output at maximum loading. Decrease the input voltage with 5 V_{AC} step. Record the input wattage and output voltage. After the output is off, increase the AC voltage gradually and record the recovery voltage.

Table 15. Test Result

Input Voltage	Input Wattage (W)	Output Voltage (V)
90 V / 60 Hz	45.75	19.10
85 V / 60 Hz	45.87	19.10
80 V / 60 Hz	46.26	19.10
75 V / 60 Hz	46.62	19.10
70 V / 60 Hz	0	0
65 V / 60 Hz	0	0
60 V / 60 Hz	0	0
55 V / 60 Hz	0	0

20. V_{DD} Voltage Level

Table 16. Test Result

	Minimum Load (V)	Maximum Load (V)	Near OPP (V)	Output S.C. (Maximum Value) (V)
90 V / 60 Hz	12.45	14.80	16.40	15.95
264V / 50 Hz	12.60	14.00	15.00	15.95

20.1. Measured Waveform

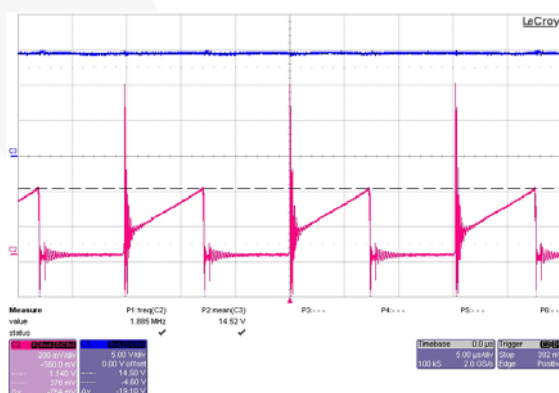

Figure 22. 90 V / 60 Hz at Maximum Load, Ch1: V_{DD}, Ch2: V_{CS}

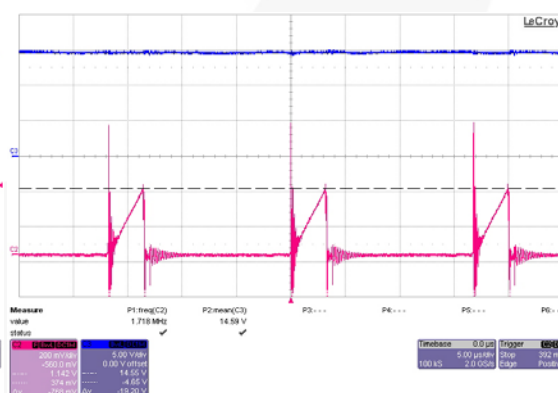

Figure 23. 264 V / 50 Hz at Maximum Load, Ch1: V_{DD}, Ch2: V_{CS}

21. Voltage Stress on MOSFET & Rectifiers

21.1. Test Condition

Measure the voltage stress on the MOSFET and secondary rectifiers under below specified conditions.

Table 17. Test Result

	Stress On MOSFET	Rating	Stress On Output Rectifier	Rating
90 V / 60 Hz, Maximum Load	322	600 V	55	100 V
90 V / 60 Hz, Maximum Load, Startup	361		49	
90 V / 60 Hz, Maximum Load, Output Short	294		28	
264 V / 50 Hz, Maximum Load	582		86	
264 V / 50 Hz, Maximum Load, Startup	534		99	
264 V / 50 Hz, Maximum Load, Output Short	502		93	
264 V / 50 Hz, Maximum Load Turns Off	322		55	

21.2. Measured Waveform

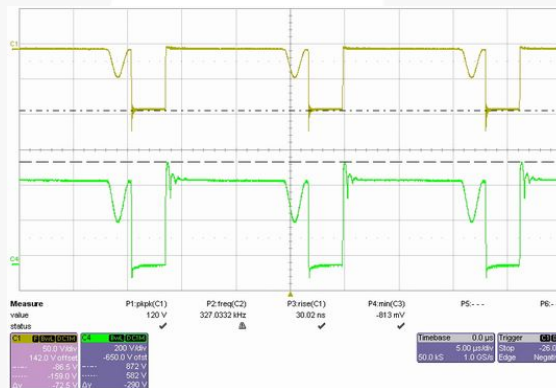

Figure 24. 264 V / 50 Hz at Maximum Load, Ch1: $V_{DS}(\text{MOSFET})$, Ch4: $V_{AK}(\text{RECTIFIER})$

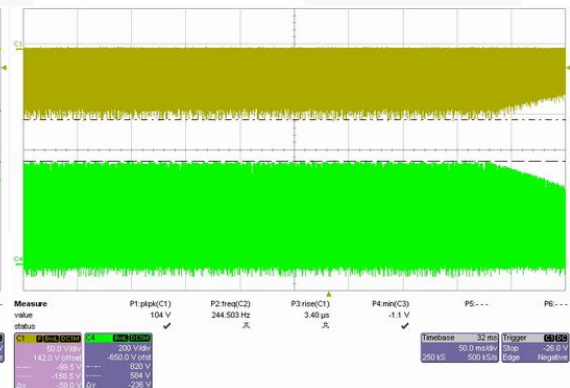

Figure 25. 264 V / 50 Hz at Maximum Load (Turns Off), Ch1: $V_{DS}(\text{MOSFET})$, Ch4: $V_{AK}(\text{RECTIFIER})$

21.3. Electromagnetic Interference (EMI) Test

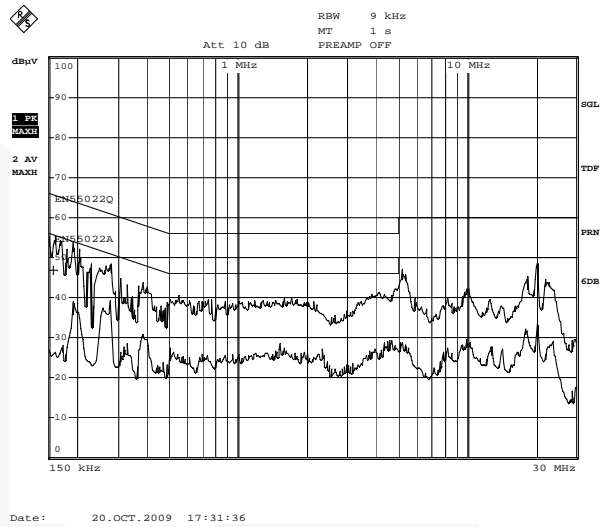
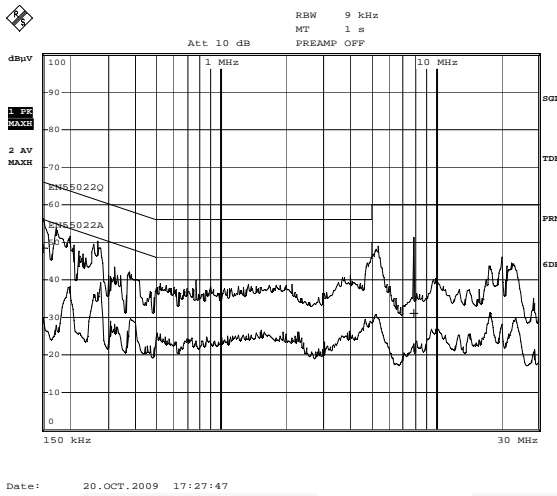

Figure 26. Conduction-Line & Neutral at 115V_{AC}

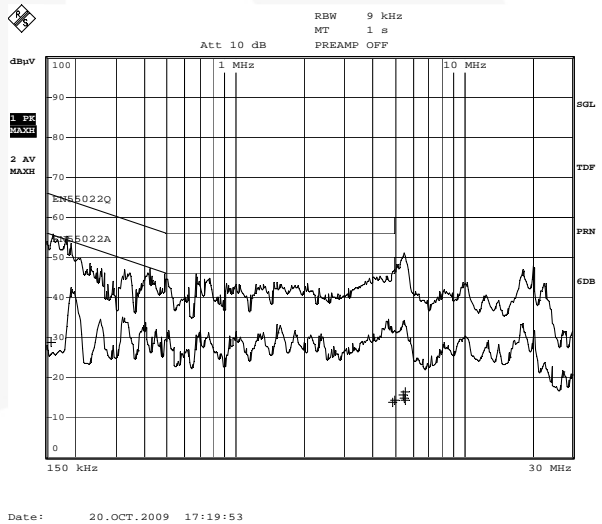
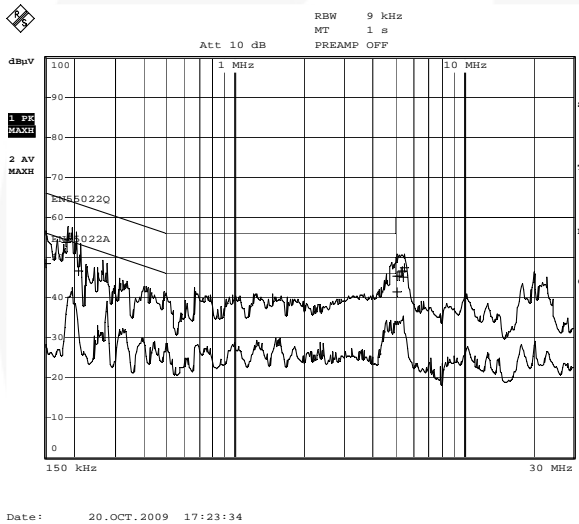

Figure 27. Conduction-Line & Neutral At 115V_{AC}

22. Surge Test

Mode	Polarity	Phase	Voltage	Condition
L-PE	±	0°	4.4 kV	Pass
	±	90°		Pass
	±	180°		Pass
	±	270°		Pass
N-PE	±	0°	4.4 kV	Pass
	±	90°		Pass
	±	180°		Pass
	±	270°		Pass
L-N	±	0°	2.0 kV	Pass
	±	90°		Pass
	±	180°		Pass
	±	270°		Pass

23. ESD Test

Air Discharge (16.5 kV)		Contact Discharge (8.8 kV)	
Pass	Pass	Pass	Pass

SPECIFICATION APPROVAL

Customer	SYSTEM GENERAL CORP.			P/N:	TRN-0279
DATE	08/02/2010	Version	A	Page	1/1

1. DIMENSION :

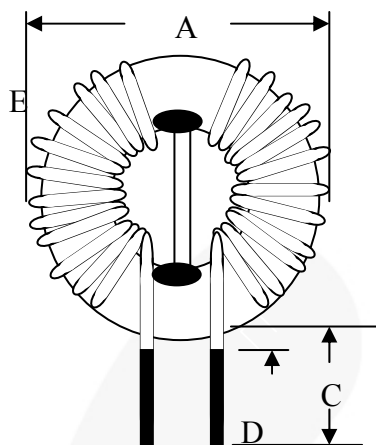

UNIT : mm

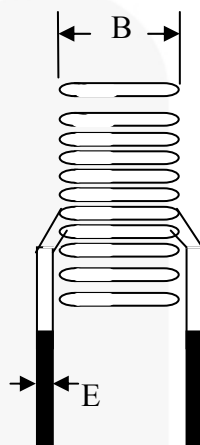

A	22 max
B	12 max
C	18 ± 1
D	15 max
E	φ0.6 ±0.1

2. ELECTRICAL SPECIFICATION : at 1 kHz, 1 V

2.1 INDUCTANCE : L1=L2 : 22 mH min

2.2 DC RESISTANCE : L1=L2 : 0.78 Ohm max

2.3 TURN & WIRE : L1=L2 : φ0.6 x 40TS

MATERIALS LIST :

COMPONENT	MATERIAL	MANUFACTURE	UL FILE NO.
1.CORE	T18.5x9.8x7	core T18.5x9.8x8 JFE FERRITE Corp.	
2.WIRE	THFN-216	Ta Ya electric wire CO.,LTD	E197768
	UEWN/U	PACIFIC wire & cable CO.,LTD	E201757
	UEWE	Tai-l electric wire & cable CO.,LTD	E85640
	UWY	Jang Shing wire CO.,LTD	E174837
3.SOLDER	96.5% Sn,3% Ag,0.5% Cu,	Xin Yuan CO.,LTD	

UNIT	m/m	DRAWN	CHECK	TITLE	
TEL	(02)29450588	Ci wun Chen	Guo long Huang	IDENT N O.	TRN-0279
FAX	(02)29447647	SEN HUEI INDUSTRIAL CO.,LTD.		D W G N O.	
No.26-1, Lane 128, Sec. 2, Singnan Rd., Jhonghe City, Taipei County 235, Taiwan (R.O.C.)					

SPECIFICATION APPROVAL

Customer	SYSTEM GENERAL CORP.			P/N:	TRN-0280
DATE	08/12/2010	Version	A	Page	1/4

1.DIMENSION : Unit : mm

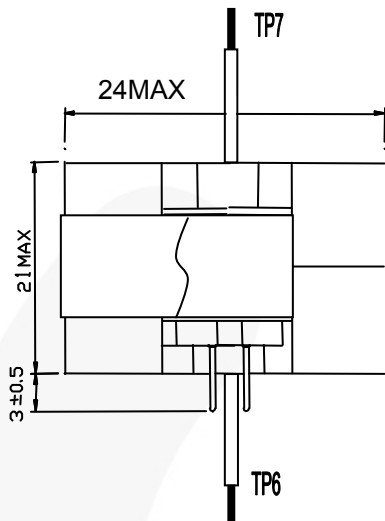

ELEVATION VIEW

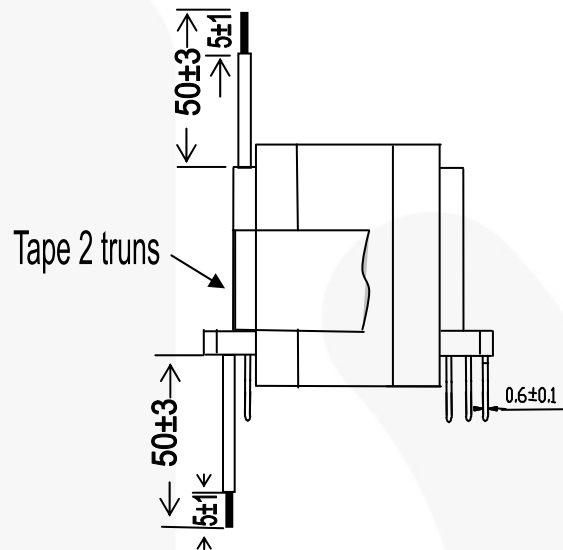

SIDE VIEW

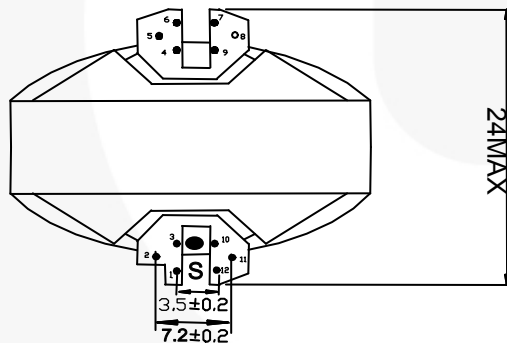

BOTTOM VIEW

TRN-0280

Past label on the top of transformer,
and the wording peak faces pin 1 & pin 12

NOTE:

- 1) Cut off pin 2,4,5,6,7,8,9,12.
- 2) Core package of two turns tape.

UNIT	m/m	DRAWN	CHECK	TITLE	TRANS
TEL	(02)29450588	Ci wun Chen	Guo long Huang	IDENT N O.	TRN-0280
FAX	(02)29447647	SEN HUEI INDUSTRIAL CO.,LTD.		D W G N O.	I0802
No.26-1, Lane 128, Sec. 2, Singnan Rd., Jhonghe City, Taipei County 235, Taiwan (R.O.C.)					

SPECIFICATION APPROVAL

Customer	SYSTEM GENERAL CORP.			P/N:	TRN-0280
DATE	08/12/2010	Version	A	Page	2/4

2.SCHEMATIC :

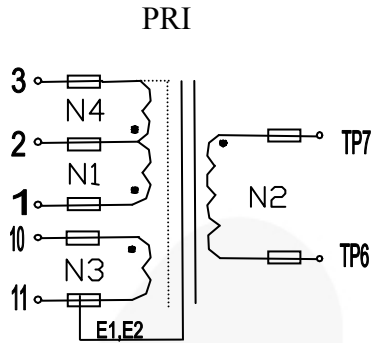

2.1SCHEMATIC :

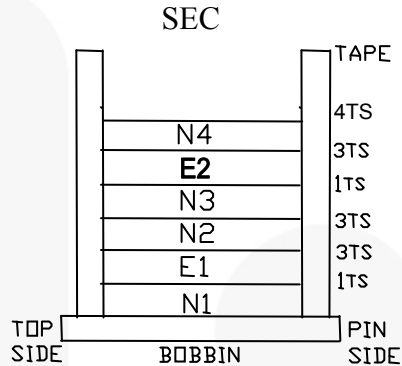

Note: The shielding winds Copper Foil 7.5mm, and connects the pin11.

2.3 WINDING :

SET	WINDING	MATERIAL	START-FINISH	TURNS	TAPE	REMARK
1	N1	2UEW-φ0.25×1P	1-2	33 ^{TS}	1 ^{TS}	
2	E1	2UEW-φ0.2×1P	11	1.2 ^{TS}	3 ^{TS}	Add 7.5 mm tape of copper foil
3	N2	TLW-φ0.5×2P	TP6-TP7	12 ^{TS}	3 ^{TS}	Add Tube of Teflon
4	N3	2UEW-φ0.25×1P	10-11	9 ^{TS}	1 ^{TS}	
5	E2	2UEW-φ0.2×1P	11	1.2 ^{TS}	3 ^{TS}	Add 7.5 mm tape of copper foil
6	N4	2UEW-φ0.25×1P	2-3	33 ^{TS}	4 ^{TS}	

UNIT	m/m	DRAWN	CHECK	TITLE	TRANS
TEL	(02)29450588	Ci wun Chen	Guo long Huang	IDENT N O.	TRN-0280
FAX	(02)29447647	SEN HUEI INDUSTRIAL CO.,LTD.		D W G N O.	I0802
No.26-1, Lane 128, Sec. 2, Singnan Rd., Jhonghe City, Taipei County 235, Taiwan (R.O.C.)					

SPECIFICATION APPROVAL

Customer	SYSTEM GENERAL CORP.			P/N:	TRN-0280
DATE	08/12/2010	Version	A	Page	3/4
<p>3.ELECTRICAL SPECIFICATION :</p> <p>3.1 Inductance test : at 1 KHz ,1 V L3-1=920 μH\pm5%</p> <p>3.2 Leakage inductance : at 1 KHz ,1 V P(4-6) : 15 μH Max (shorted A,B)</p> <p>3.3 DC Resistance test at 25°C P(4-6) : 23 mΩ Max</p> <p>3.4 Hi-pot test :</p> <p>AC 3.0 KV /60 Hz/0.5 mA hi-pot for one minute between primary to sec. AC 1.5 KV /60 Hz/0.5 mA hi-pot for one minute between primary to core. AC 1.5 KV /60 Hz/0.5 mA hi-pot for one minute between sec to core.</p> <p>3.5 Insulation test :</p> <p>The insulation resistance is between primary to sec and windings to core measured by DC 500 V, must Be over 100 MΩ.</p> <p>3.6 Terminal strength :</p> <p>1.0 Kg on terminals for 30 seconds, test the breakdown.</p>					
UNIT	m/m	DRAWN	Ci wun Chen	CHECK	Guo long Huang
TEL	(02)29450588	SEN HUEI INDUSTRIAL CO.,LTD.		IDENT N O.	TRN-0280
FAX	(02)29447647			D W G N O.	I0802
No.26-1, Lane 128, Sec. 2, Singnan Rd., Jhonghe City, Taipei County 235, Taiwan (R.O.C.)					

SPECIFICATION APPROVAL

Customer	SYSTEM GENERAL CORP.			P/N:	TRN-0280
DATE	08/12/2010	Version	A	Page	4/4

MATERIALS LIST

COMPONENT	MATERIAL	MANUFACTURE	FILE NO.
1.Bobbin	Phenolic 94v-0,T375J,150°C	RM-8 Chang Chun plastics co. ltd.	E59481(S)
2.Core	FERRITE 3C90 R2K (GAP)	Ferrite core RM-8 YANG GUANG DA CO.,LTD	
3.Wire	UEY 130°C	HOI LUEN ELECTRICAL MFR CO.,LTD	E164409
	TEX-E 130°C	SHEN ZHEN CHANGYUAN ELECTRONIC MATERIAL CO.,LTD	E249037
4.Varnish	48562/C 155°C	HANG CHEUNG PETROCHEMICAL LTD	E200154
5.Tape	MYLAR TAPE (PZ-YELLOW)	JINGJIANG YA HUA PRESSURE SENSITIVE GLUE CO.,LTD	E165111(N)
6.Tube	TEFOLN 200°C 150V	SHEN ZHEN WOER HEAT SHRINKABLE MATERIAL CO.,LTD	E203950
7.Terminals	Tin coated- Copper wire	Will fore special wire corp	
8.Shield	Copper foil	BO TONG CO.,LTD (copper foil : T0.025mm×7mm +TAPE)	
9.SOLDER	96.5% Su 3% Ag 0.5% Cu	Xin Yuan CO.,LTD	

UNIT	m/m	DRAWN	CHECK	TITLE	TRANS
TEL	(02)29450588	Ci wun Chen	Guo long Huang	IDENT N O.	TRN-0280
FAX	(02)29447647	SEN HUEI INDUSTRIAL CO.,LTD.		D W G N O.	I0802
No.26-1, Lane 128, Sec. 2, Singnan Rd., Jhonghe City, Taipei County 235, Taiwan (R.O.C.)					

24. Revision History

Rev.	Date	Description
1.0.0	September 2012	Initial Release

WARNING AND DISCLAIMER

Replace components on the Evaluation Board only with those parts shown on the parts list (or Bill of Materials) in the Users' Guide. Contact an authorized Fairchild representative with any questions.

This board is intended to be used by certified professionals, in a lab environment, following proper safety procedures. Use at your own risk. The Evaluation board (or kit) is for demonstration purposes only and neither the Board nor this User's Guide constitute a sales contract or create any kind of warranty, whether express or implied, as to the applications or products involved. Fairchild warrants that its products meet Fairchild's published specifications, but does not guarantee that its products work in any specific application. Fairchild reserves the right to make changes without notice to any products described herein to improve reliability, function, or design. Either the applicable sales contract signed by Fairchild and Buyer or, if no contract exists, Fairchild's standard Terms and Conditions on the back of Fairchild invoices, govern the terms of sale of the products described herein.

DISCLAIMER

FAIRCHILD SEMICONDUCTOR RESERVES THE RIGHT TO MAKE CHANGES WITHOUT FURTHER NOTICE TO ANY PRODUCTS HEREIN TO IMPROVE RELIABILITY, FUNCTION, OR DESIGN. FAIRCHILD DOES NOT ASSUME ANY LIABILITY ARISING OUT OF THE APPLICATION OR USE OF ANY PRODUCT OR CIRCUIT DESCRIBED HEREIN; NEITHER DOES IT CONVEY ANY LICENSE UNDER ITS PATENT RIGHTS, NOR THE RIGHTS OF OTHERS.

LIFE SUPPORT POLICY

FAIRCHILD'S PRODUCTS ARE NOT AUTHORIZED FOR USE AS CRITICAL COMPONENTS IN LIFE SUPPORT DEVICES OR SYSTEMS WITHOUT THE EXPRESS WRITTEN APPROVAL OF THE PRESIDENT OF FAIRCHILD SEMICONDUCTOR CORPORATION.

As used herein:

- Life support devices or systems are devices or systems which, (a) are intended for surgical implant into the body, or (b) support or sustain life, or (c) whose failure to perform when properly used in accordance with instructions for use provided in the labeling, can be reasonably expected to result in significant injury to the user.
- A critical component is any component of a life support device or system whose failure to perform can be reasonably expected to cause the failure of the life support device or system, or to affect its safety or effectiveness.

ANTI-COUNTERFEITING POLICY

Fairchild Semiconductor Corporation's Anti-Counterfeiting Policy. Fairchild's Anti-Counterfeiting Policy is also stated on our external website, www.fairchildsemi.com, under Sales Support.

Counterfeiting of semiconductor parts is a growing problem in the industry. All manufacturers of semiconductor products are experiencing counterfeiting of their parts. Customers who inadvertently purchase counterfeit parts experience many problems such as loss of brand reputation, substandard performance, failed applications, and increased cost of production and manufacturing delays. Fairchild is taking strong measures to protect ourselves and our customers from the proliferation of counterfeit parts. Fairchild strongly encourages customers to purchase Fairchild parts either directly from Fairchild or from Authorized Fairchild Distributors who are listed by country on our web page cited above. Products customers buy either from Fairchild directly or from Authorized Fairchild Distributors are genuine parts, have full traceability, meet Fairchild's quality standards for handling and storage and provide access to Fairchild's full range of up-to-date technical and product information. Fairchild and our Authorized Distributors will stand behind all warranties and will appropriately address any warranty issues that may arise. Fairchild will not provide any warranty coverage or other assistance for parts bought from Unauthorized Sources. Fairchild is committed to combat this global problem and encourage our customers to do their part in stopping this practice by buying direct or from authorized distributors.

EXPORT COMPLIANCE STATEMENT

These commodities, technology, or software were exported from the United States in accordance with the Export Administration Regulations for the ultimate destination listed on the commercial invoice. Diversion contrary to U.S. law is prohibited.

U.S. origin products and products made with U.S. origin technology are subject to U.S. Re-export laws. In the event of re-export, the user will be responsible to ensure the appropriate U.S. export regulations are followed.