

SN2100 Bluetooth Class 1 Module

User Manual And Datasheet

Version: 1.0

Aug 13, 2012

Note: SyChip, L.L.C. reserves the right to make changes in specifications at any time and without notice. The information furnished in this data sheet is believed to be accurate and reliable. However, no responsibility is assumed by SyChip for its use, nor any infringements of patents or other rights of third parties resulting from its use. No license is generated under any rights of SyChip or its supporters unless specifically agreed.

Revision History

Revision	Date	Author	Change Description
0.1	Jul-07-2011		Release the first datasheet.
0.5	Nov-15-2011	N. Nagayama	Update the block diagram / BT IC product number Update the SyChip Part Number
0.6	Jan-05-2012	Viet H.	Update the spec table
0.61	Jan-31-2012	Y Fang	Added disclaimer
0.62	Apr-10-2012	JAG	Added packaging, labeling and regulatory information
0.63	May-22-2012	Viet H.	Update the spec table
1.0	Aug 10	Y Fang	Added Software and Development Tool sections

Table of Contents

1	SYSTEM DESCRIPTIONS	6
1.1	APPLICATIONS	6
1.2	MODULE SUMMARY	6
1.3	BLOCK DIAGRAM	7
2	MECHANICAL SPECIFICATIONS	8
2.1	MODULE DIMENSION.....	8
2.2	MODULE TOP AND SIDE VIEW	8
2.3	MODULE BOTTOM VIEW.....	9
2.4	DETAILED MECHANICAL DATA (TOP VIEW).....	10
2.5	MODULE PIN-OUT.....	11
3	DC ELECTRICAL SPECIFICATIONS	13
3.1	TYPICAL POWER CONSUMPTION.....	13
3.2	DIGITAL IO SPECIFICATION	13
4	RF SPECIFICATIONS	14
4.1	BLUETOOTH SPECIFICATION	14
4.2	RF CHARACTERISTICS (TX)	14
4.3	RF CHARACTERISTICS (RX).....	16
5	ENVIRONMENTAL SPECIFICATIONS	17
5.1	ABSOLUTE MAXIMUM RATINGS	17
5.2	OPERATION CONDITIONS	17
6	APPLICATION INFORMATION	18
6.1	HOST PCB LAYOUT RECOMMENDATIONS	18
6.2	MODULE LOCATION	19
6.2.1	<i>Location in x-y plane</i>	19
6.2.2	<i>Location in z-plane</i>	20
7	SOFTWARE	21
7.1	SOFTWARE ARCHITECTURE	21
7.2	BLUETOOTH PROFILE STACKS	21
8	DEVELOPMENT TOOLS	22
9	ASSEMBLY INFORMATION	23
9.1	LEAD-FREE SOLDERING REFLOW PROFILE.....	23
10	PACKAGING AND MARKING INFORMATION	24
10.1	CARRIER TAPE DIMENSIONS	24
10.2	MODULE MARKING INFORMATION	24
11	ORDERING INFORMATION	25
12	ROHS DECLARATION	25
13	REGULATORY INFORMATION	25
13.1	FCC NOTICE (USA)	25
13.2	FCC LABELING REQUIREMENTS.....	26
13.3	RF EXPOSURE.....	26



Murata Wireless Solutions



13.4	IC NOTICE (CANADA).....	26
13.5	IC LABELING REQUIREMENTS	27
13.6	CE NOTICE (EUROPE).....	27
13.7	CE LABELING REQUIREMENTS	27
14	TECHNICAL SUPPORT CONTACT	28
15	DISCLAIMER	28

LIST OF FIGURES

FIGURE 1 SN2100 MODULE BLOCK DIAGRAM	7
FIGURE 2 MODULE TOP AND SIDE VIEW	8
FIGURE 3 MODULE BOTTOM VIEW	9
FIGURE 4 DETAILED MECHANICAL DATA (TOP VIEW).....	10
FIGURE 5 RECOMMENDED HOST CIRCUIT BOARD DESIGN UNDERNEATH THE MODULE.....	18
FIGURE 6 RECOMMENDED LOCATIONS IN XY-PLANE	19
FIGURE 7 LOCATIONS NOT RECOMMENDED IN XY-PLANE	19
FIGURE 8 RECOMMENDED LOCATIONS IN Z-PLANE.....	20
FIGURE 9 LOCATIONS NOT RECOMMENDED IN XY-PLANE	20
FIGURE 10 REFLOW PROFILE PATTERN	23
FIGURE 11 CARRIER TAPE DIMENSIONS.....	24
FIGURE 12 MODULE MARKING DETAIL.....	24

LIST OF TABLES

TABLE 1 MODULE CONNECTOR SIGNAL DESCRIPTION.....	11
TABLE 2 TYPICAL POWER CONSUMPTION.....	13
TABLE 3 DIGITAL IO SPECIFICATION	13
TABLE 4 RF SPECIFICATIONS.....	14
TABLE 5 RF SPECIFICATIONS.....	16
TABLE 6 ABSOLUTE MAXIMUM RATING	17
TABLE 7 RECOMMENDED OPERATING CONDITIONS	17
TABLE 8 BLUETOOTH STACK AVAILABILITY	21
TABLE 9 DEVELOPMENT TOOLS	22
TABLE 10 REFLOW PROFILE RECOMMENDATION	23
TABLE 11 ORDERING INFORMATION.....	25

1 System Descriptions

1.1 Applications

SN2100 is a complete industrial grade high power (class 1) Bluetooth® module with on-board antenna for M2M application. It integrates Bluetooth® IC, PA, RF front end, TCXO and chip antenna into a small LGA form factor and can be simply dropped into the OEM's design. The SN2100 offers total 110 dB link budget, which is significantly better than most of the Bluetooth® modules do in the market. This makes it a good fit for industrial control application that usually requires longer distance coverage. The module offers extended product life and industrial standard operating temperature range to fit the industrial usage. The SN2100 offers standard HCI interface to the host CPU.

1.2 Module Summary

- Bluetooth V2.0
- Power Grade: Class 1
- Dimensions: 17.5mm x 16.0mm x 2.0 mm
- Supply voltage: 2.2V to 3.3V
- Antenna: on-module
- 32kHz clock circuit : on-module
- Host Interface : UART/PCM
- RoHS compliant
- MSL JEDEC level 3
- FCC/IC certified; CE compliant

1.3 Block Diagram

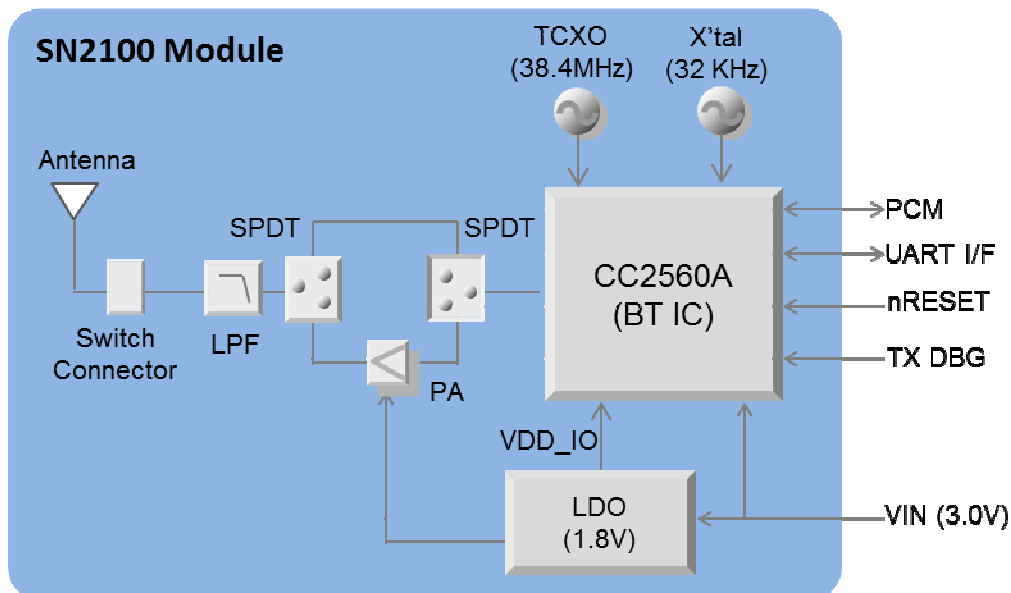

Figure 1 SN2100 Module Block Diagram

2 Mechanical Specifications

2.1 Module Dimension

Parameter	Typical	Unit
Dimension (LxWxH)	17.5 x 16.0 x 2.0	mm
Dimension tolerances (LxWxH)	+/- 0.2 mm	mm

2.2 Module top and side view

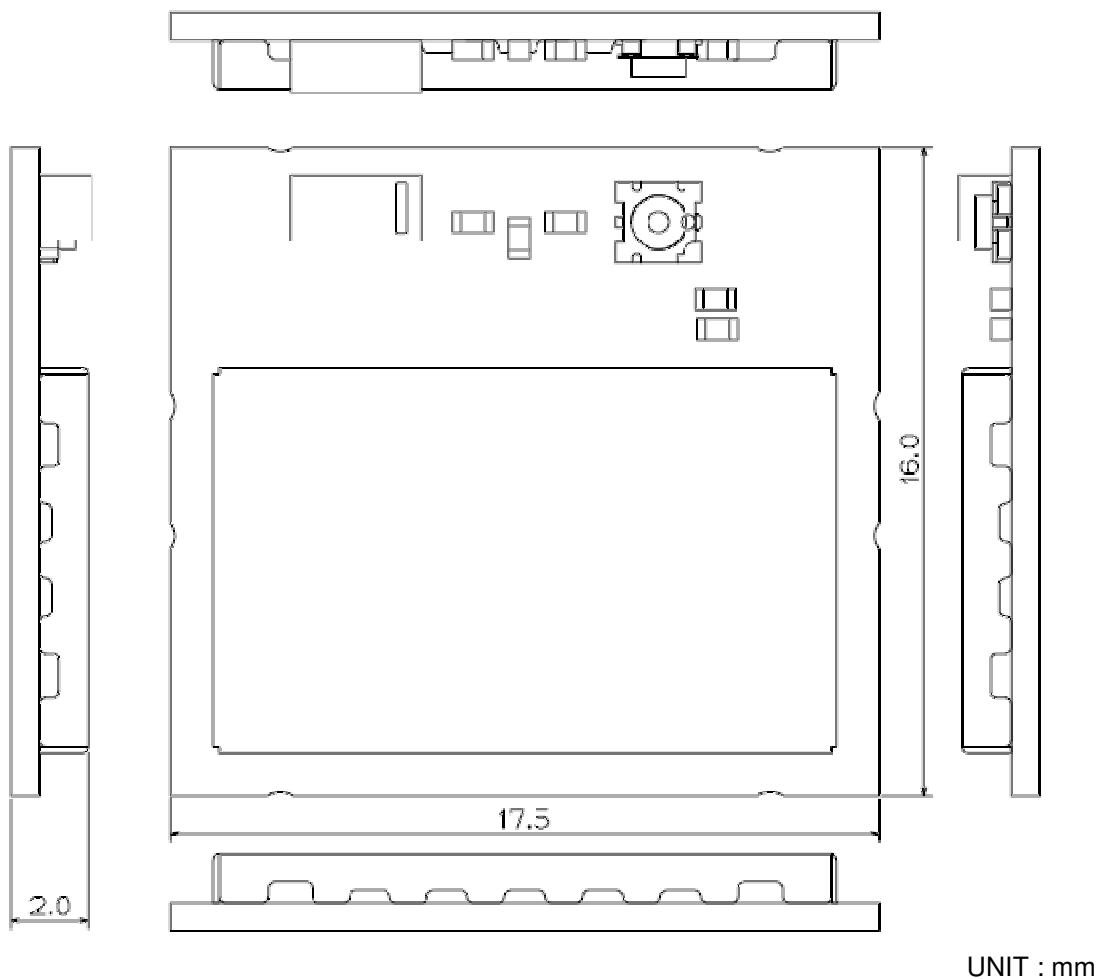

Figure 2 Module Top and Side View

2.3 Module bottom view

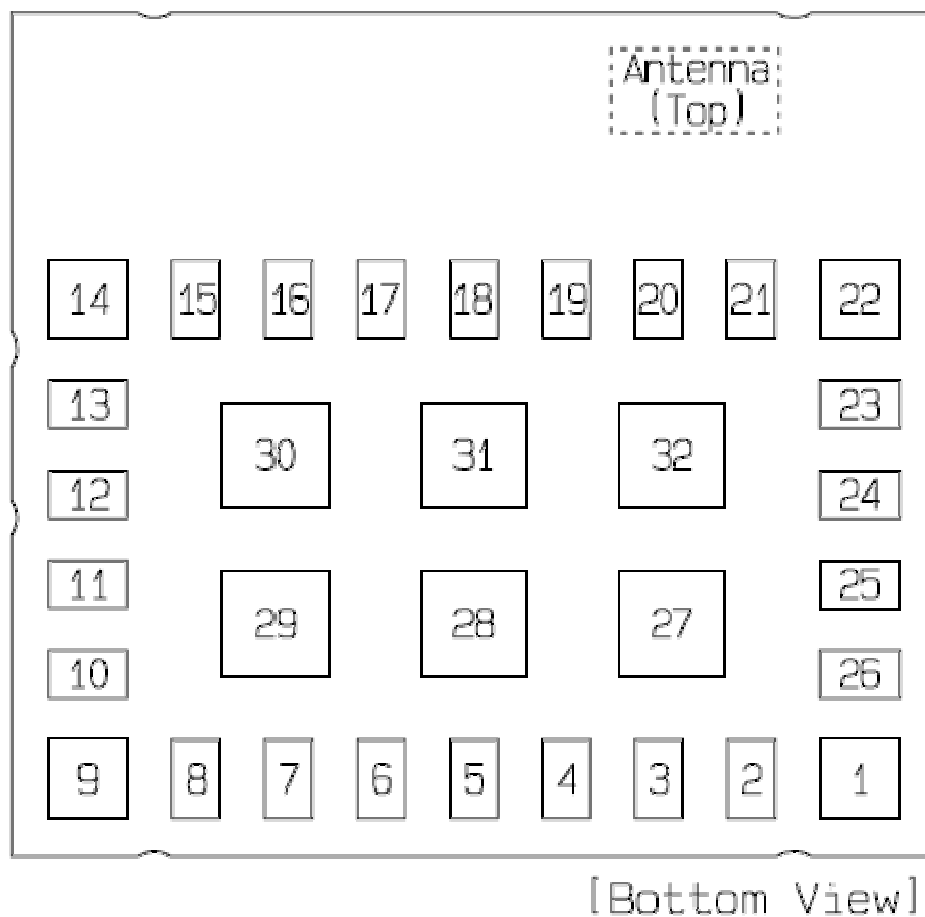

Figure 3 Module Bottom View

2.4 Detailed mechanical data (top view)

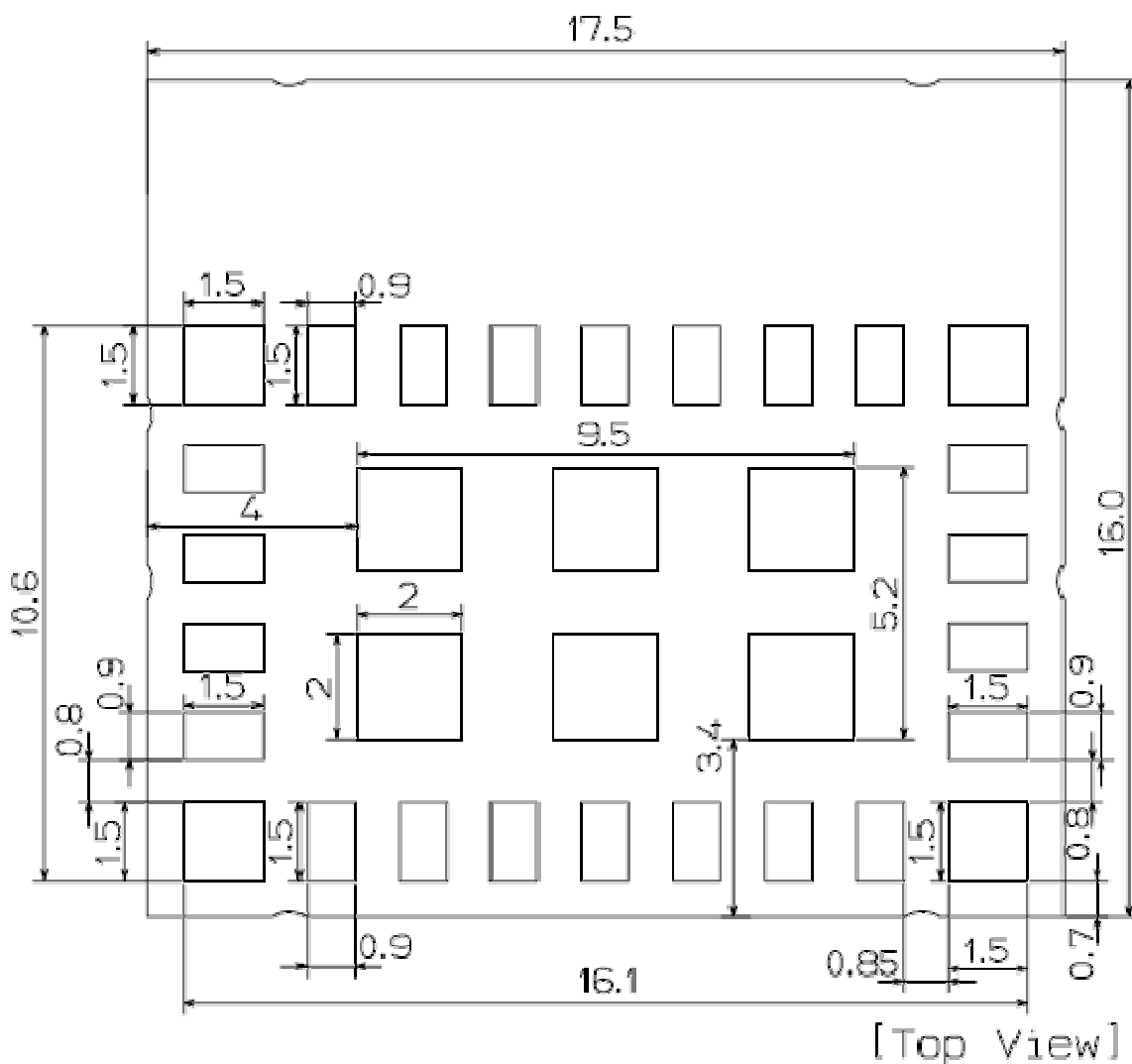

Figure 4 Detailed Mechanical Data (top view)

2.5 Module Pin-out

Table 1 Module Connector Signal Description

Pin #	Pin name	I/O	Description
1	GND	-	Ground
2	VIN	I	Module Power Supply
3	Reserved	O	Internal for debugging use only
4	HCI_CTS	I	HCI UART Clear-To-Send. Module is allowed to send data when HCI_CTS is low.
5	HCI_TX	O	HCI UART data transmit
6	HCI_RTS	O	HCI UART Request-To-Send Host is allowed to send data when RTS is low.
7	HCI_RX	I	HCI UART data receive
8	nRESET	I	Shutdown input (Active Low)
9	GND	-	Ground
10	AUD_IN	I	PCM Data Input
11	AUD_OUT	O	PCM Data Output
12	AUD_CLK	I/O	PCM Clock
13	AUD_SYNC	I/O	PCM Frame Sync
14	GND	-	Ground
15	GND	-	Ground
16	GND	-	Ground
17	GND	-	Ground
18	GND	-	Ground
19	GND	-	Ground
20	GND	-	Ground
21	GND	-	Ground
22	GND	-	Ground
23	GND	-	Ground
24	GND	-	Ground
25	GND	-	Ground
26	Reserved	-	Internal use only
27	GND	-	Ground
28	GND	-	Ground

Pin #	Pin name	I/O	Description
29	GND	-	Ground
30	GND	-	Ground
31	GND	-	Ground
32	GND	-	Ground

3 DC Electrical Specifications

3.1 Typical Power Consumption

Table 2 Typical Power Consumption

Item	Condition	Values			Units
		Min	Typ	Max	
Standby mode (after send script)	VIN = 3.0V, TEMP = 25°C	-	3.5	-	mA
TX maximum current	VIN = 3.0V, TEMP = 25°C	-	165	-	mA
RX maximum current	VIN = 3.0V, TEMP = 25°C	-	50	-	mA

3.2 Digital IO Specification

VIN = 3.0V, TEMP = 25°C, unless otherwise stated

Table 3 Digital IO Specification

Item	Condition	Symbol	Min	Max	UNIT
High Level Input Voltage		V_{IH}	0.65 x VDD	VDD	V
Low Level Input Voltage		V_{IL}	0	0.35 x VDD	V
High Level Output Voltage	At 2/4/8 mA	V_{OH}	0.8 x VDD	VDD	V
	At 0.1 mA		VDD - 0.2	VDD	V
Low Level output Voltage	At 2/4/8 mA	V_{OL}	0	0.2 x VDD	V
	At 0.1 mA		0	0.2	V

VDD : 1.8V

4 RF Specifications

4.1 Bluetooth Specification

Parameter	Contents
Bluetooth Specification	Ver.2.0
Channel Spacing	1 MHz
The number of channel	79
Power Class	1

4.2 RF Characteristics (TX)

VIN = 3.0V, TEMP = 25 °C, at 50Ω terminal load connected to the RF connector

Table 4 RF Specifications

Parameter	Min	Typ	Max	BT Spec	Units
Output Power	-	18	-	20 ⁽¹⁾	dBm
Operation Frequency range (RX/TX)	2402	-	2480	-	MHz
-20 dB bandwidth	-	0.928	-	1	MHz
Adjacent Channel Power					
[M-N] = 2	-	-40	-	<-20	dBm
[M-N] >= 3	-	-43	-	<-40	dBm
Modulation Characteristics					
Modulation delta f1 avg	-	159	-	140< <175	kHz
Modulation delta f2 max	-	136	-	115<	kHz
Modulation delta f2 avg/delta f1 avg	-	0.9	-	0.8<	-
Initial Carrier Frequency Tolerance	-	-2	-	-75< <75	kHz
Carrier Frequency Drift					
1 slot	-25	2	-	-25< <25	kHz
3 slot	-40	1	-	-40< <40	kHz
5 slot	-40	1	-	-40< <40	kHz
Maximum drift rate	-20	0.5	-	-20< <20	kHz/50 us
Out of Band Spurious Emissions					
30 – 1000 MHz (Operation Mode)	-	-50	-	<-36	dBm
1000 – 12750 MHz (Operation Mode)	-	-52	-	<-30	dBm
1800 – 1900 MHz (Operation Mode)	-	-54	-	<-47	dBm
5150 – 5300 MHz (Operation Mode)	-	-54	-	<-47	dBm

(1) EIRP.

4.3 RF Characteristics (RX)

VIN = 3.0V, TEMP = 25 °C, at 50Ω terminal load connected to the RF connector

Table 5 RF Specifications

Parameter	Min	Typ	Max	BT Spec	Units
Sensitivity (BER ≤ 0.1%)	-	-92	-	< -70	dBm
C/I Performance (BER ≤ 0.1%)					
Co-channel ratio (-60 dBm input)	-	10	-	< 11	dB
1MHz ratio (-60dBm input)	-	-7	-	< 0	dB
2MHz ratio (-60dBm input)	-	-21	-	< -30	dB
3MHz ratio (-67dBm input)	-	-44	-	< -40	dB
Blocking Performance (BER ≤ 0.1%)					
30MHz – 2000MHz	-5	-	-	-10<	dBm
2000MHz – 2400MHz	-5	-	-	-27<	dBm
2500MHz – 3000MHz	-5	-	-	-27<	dBm
3000MHz – 12750MHz	-5	-	-	-10<	dBm
Intermodulation Performance (BER ≤ 0.1%, -64 dBm input)	-	-36	-	-39<	dBm
Maximum Input Level	-4	-	-	-20<	dBm

5 Environmental Specifications

5.1 Absolute maximum ratings

Table 6 Absolute Maximum Rating

Symbol	Description	Min	Max	Units
T _{op}	Operating temperature	-40	85	°C
T _{st}	Storage temperature	-40	85	°C
V _{IN}	Power supply	-0.3	5.0	V
MSL	Moisture Sensitivity Level	3		
RoHS	Restriction of Hazardous Substances	Compliant		

5.2 Operation conditions

Table 7 Recommended Operating Conditions

Symbol	Parameter	Min	Typ	Max	Units
V _{IN}	Power supply	2.2	3.0	3.3	V
T _{op}	Operating temperature	-40	-	85	°C

6 Application Information

6.1 Host PCB layout recommendations

The SN3020 module has an onboard antenna therefore it requires some special host PCB layout underneath the module such that the radio can achieve its best RF performance. Refer to Figure 5 for the requirements.

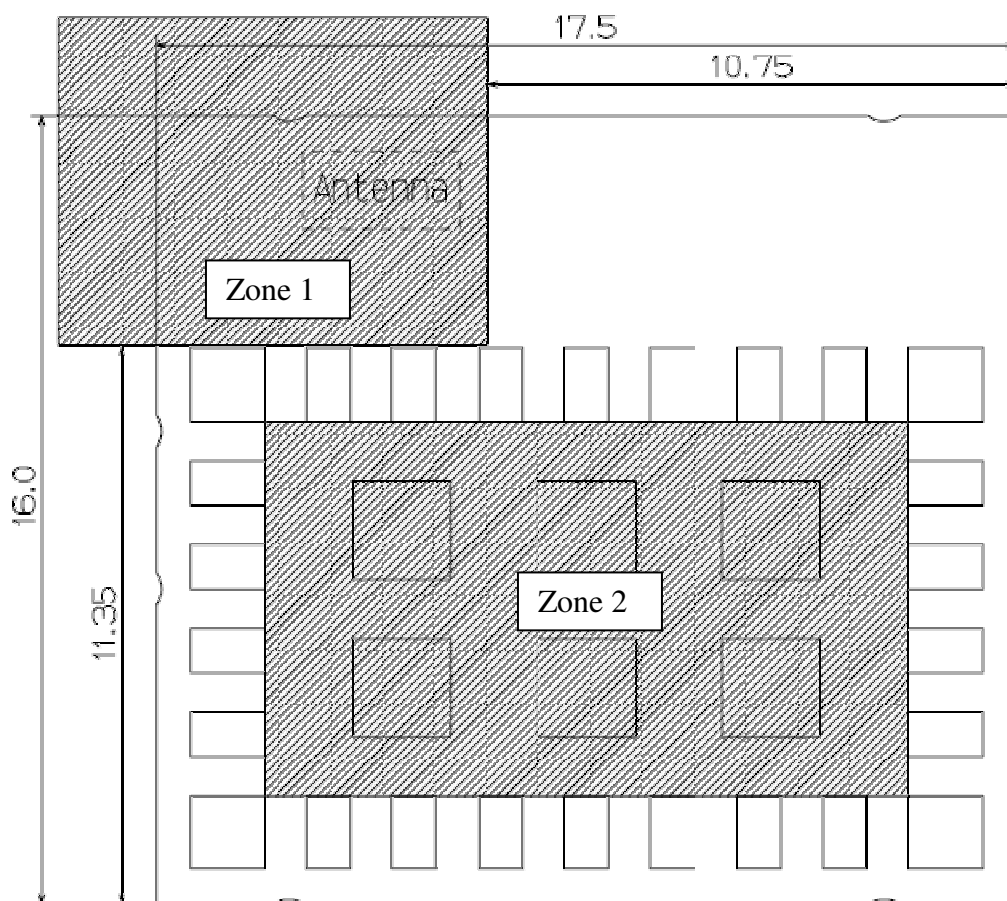

Figure 5 Recommended Host Circuit Board Design underneath the Module

Notes:

1. Due to the surface mount antenna on the module, the area in 'Zone1' on all layers of the customer circuit board should be free of any metal objects. Specifically, there should be no ground plane, traces, or metal shield case.
2. The area in 'Zone2' on the top layer of the customer circuit board should have ground only with no signal traces.

6.2 Module Location

For optimum EIRP, customer is advised to use the recommended module location on their respective PCB.

6.2.1 Location in x-y plane

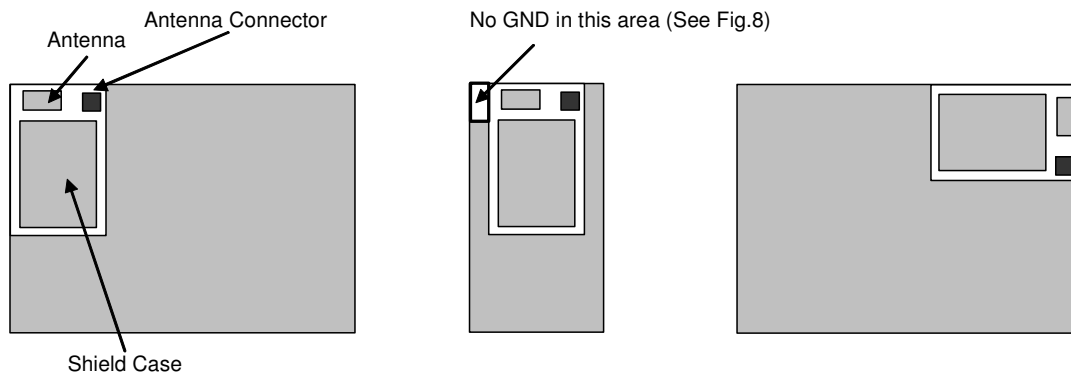

Figure 6 Recommended Locations in xy-plane

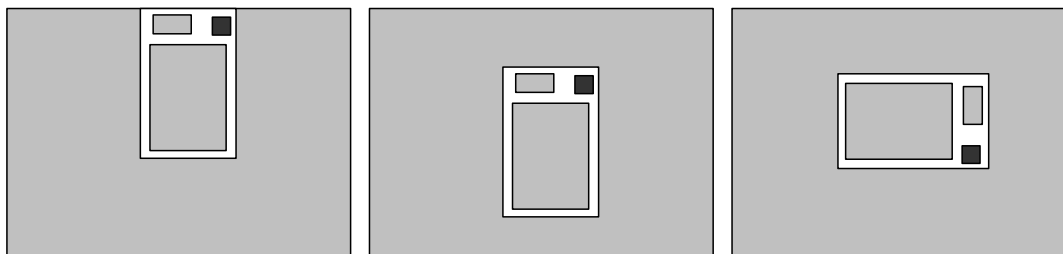

Figure 7 Locations Not Recommended in xy-plane

6.2.2 Location in z-plane

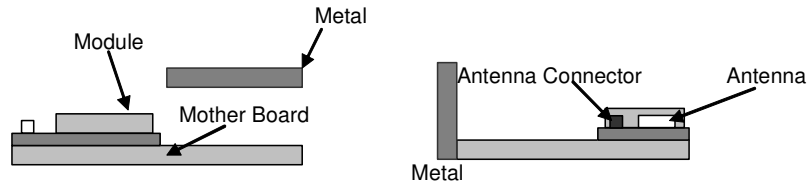

Figure 8 Recommended Locations in z-plane

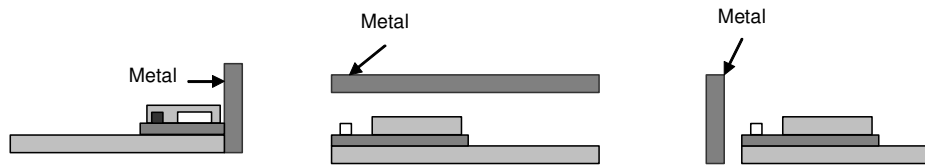

Figure 9 Locations Not Recommended in xy-plane

7 Software

7.1 Software Architecture

SN2100 module communicates with host processor via HCI interface. The HCI interface transports commands, events, ACL, and synchronous data between the device and the host using HCI data packets.

The Bluetooth profile stack beyond HCI layer is required to be supported from host processor.

7.2 Bluetooth Profile Stacks

The table below lists the available Bluetooth Profiles and the sources.

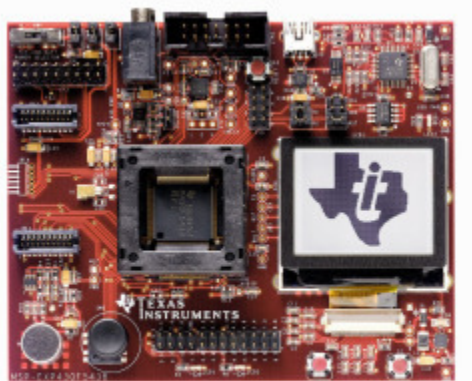

Table 8 Bluetooth Stack Availability

Profiles	Source	Platform
SPP, A2DP and others	Stonestreet One	TI MSP430, TI Stellaris

8 Development Tools

SN2100 EM Development Kit is offered for customer application development on Texas Instruments MSP430 and Stellaris® platform. The table below lists the related tools that the customer may need.

Table 9 Development Tools

	Tool	Description	Online Resources
1	88-00150-85	SN2100 EM Development Kit 	http://www.murata-ws.com/2100.htm
2	TI MSP-EXP430F5438	MSP430 Experimenter Board  MSP-EXP430F5438 MSP430F5438 Experimenter Board	http://www.ti.com/tool/msp-exp430f5438
3	TI MSP-FET430UIF	MSP430 USB Debugging Interface  TEXAS INSTRUMENTS MSP430	http://www.ti.com/tool/msp-fet430uif

9 Assembly Information

9.1 Lead-free soldering reflow profile

The lead-free solder reflow profile is recommended in the table & graph below. The profile is used to attach the module to its host PCB.

The module is designed to withstand 2 reflows. Opposite side reflow is prohibited due to the module weight.

Table 10 Reflow Profile Recommendation

Ramp up rate	3°C/second max
Maximum time maintained above 217°C	120 seconds
Peak temperature	250°C
Maximum time within 5°C of peak temperature	20 seconds
Ramp down rate	6°C/second max

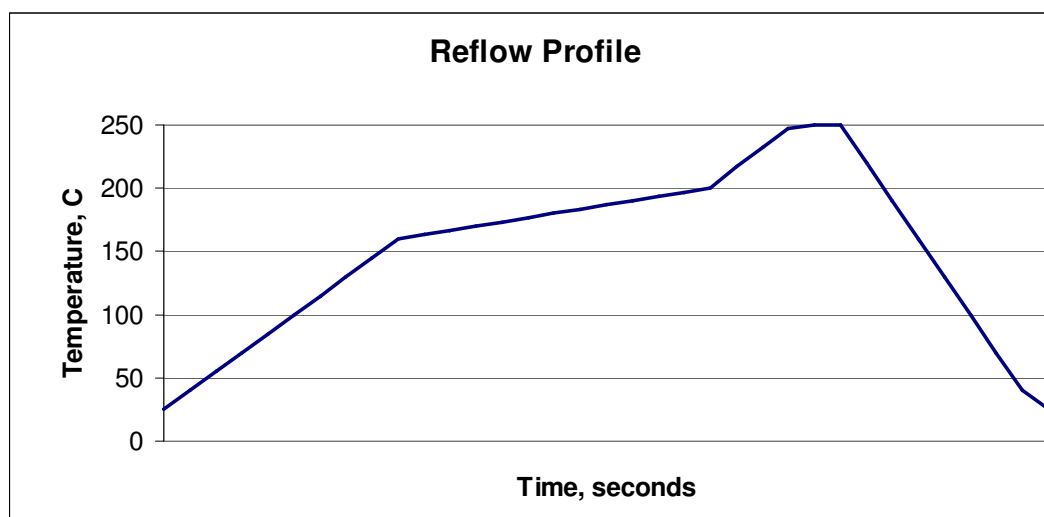
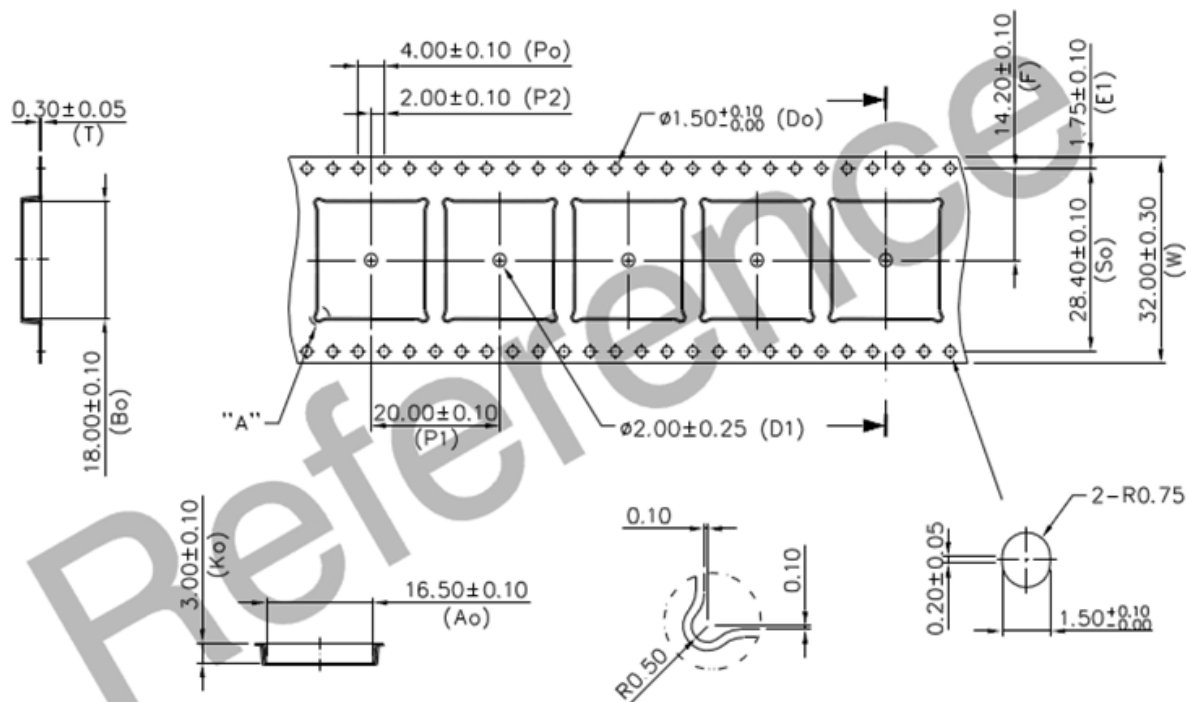

Figure 10 Reflow Profile Pattern

10 Packaging and Marking Information

10.1 Carrier Tape Dimensions



NOTES:
1. DIM IN MM.

Figure 11 Carrier Tape Dimensions

10.2 Module Marking Information

The following marking information may be printed on a permanent label affixed to the module shield or permanently laser written into the module shield itself. The 2D barcode is used for internal purposes. A pin 1 ID is stamped into the shield.



Figure 12 Module Marking Detail

11 Ordering Information

Table 11 Ordering Information

Product	SyChip Model Number	SyChip Part Number	Standard Order Increment
EM Development Kit	SN2100EMK	88-0150-85	1 pc
Module in Tape and Reel	SN2100	88-0150-00	500 pcs

12 RoHS Declaration

Given supplier declarations, this product does not contain substances that are banned by Directive 2002/95/EC or contains a maximum concentration of 0.1% by weight in homogeneous materials for

- Lead and lead compounds
- Mercury and mercury compounds
- Chromium (VI)
- PBB (polybrominated biphenyl)
- PBDE (polybrominated biphenyl ether)

And a maximum concentration of 0.01% by weight in homogeneous materials for

- Cadmium and cadmium compounds

13 Regulatory Information

SN2100 has obtained the certifications described below.

13.1 FCC Notice (USA)

This device using the integrated antenna has been tested to comply with FCC CFR Part 15. The device meets the requirements for modular transmitter approval as detailed in the FCC public notice DA00.1407. Operation is subject to the following two conditions: (1) this device may not cause harmful interference, and (2) this device must accept any interference received, including interference that may cause undesired operation.

The FCC requires the OEM (original equipment manufacturer) to be notified that any changes or modifications not expressly approved by SyChip, L.L.C may void the user's authority to operate the equipment. While an application of the SN2100 module in a product is not required to obtain a new FCC authorization for the module, this does not preclude the possibility that some other form of authorization or testing may be required for that end product.

This equipment has been tested and found to comply with the limits for a Class B digital device, pursuant to Part 15 of the FCC Rules. These limits are designed to provide reasonable protection against harmful interference in a residential installation. This equipment generates uses and can radiate radio frequency energy and, if not installed and used in accordance with the instructions, may cause harmful interference to radio communications. However, there is no guarantee that interference will not occur in a particular installation. If this equipment does cause harmful interference to radio or television reception, which can be determined by turning the equipment off and on, the user is encouraged to try to correct the interference by one or more of the following measures: reorient or relocate the receiving antenna, increase the separation between the equipment and receiver, connect the equipment into an outlet on a circuit different from that to which the receiver is connected, or consult the dealer or an experienced radio/TV technician for help.

13.2 FCC Labeling Requirements

When integrating the SN2100 into a product, the FCC labeling requirements must be met by the OEM. This includes placing a clearly visible label on the outside of the finished product specifying the SN2100 FCC identifier (FCC ID:QPU2100) as well as the underlined FCC Notice above. The exterior label can use wording such as “Contains Transmitter Module FCC ID:QPU2100” or “Contains FCC ID:QPU2100” although any similar wording that expresses the same meaning may be used.

13.3 RF Exposure

This module has been certified for remote and base radio applications and is not intended to be operated within 20cm of the body. If the module will be used for portable applications, the device must undergo SAR testing.

The following statement must be included as a CAUTION statement in manuals for the products to alert users on FCC RF exposure compliance:

“WARNING: To satisfy FCC RF exposure requirements for mobile transmitting devices, a separation distance of 20cm or more should be maintained between the antenna of this device and persons during operation. To ensure compliance, operations at closer distances than this are not recommended.”

13.4 IC Notice (Canada)

The term “IC” before the certification/registration number only signifies that the Industry Canada technical specifications were met.

Le terme “IC” devant le numéro de certification /d’enregistrement signifie seulement que les spécifications techniques Industrie Canada ont été respectées.

This device complies with Industry Canada license-exempt RSS standard(s). Operation is subject to the following two conditions: (1) this device may not cause interference, and (2) this device must accept any interference, including interference that may cause undesired operation of the device.

Cet appareil est conforme avec Industrie Canada RSS standard exempts de licence (s). Son utilisation est soumise à Les deux conditions suivantes: (1) cet appareil ne peut pas provoquer d'interférences et (2) cet appareil doit accepter Toute interférence, y compris les interférences qui peuvent causer un mauvais fonctionnement du dispositif.

This device complies with Health Canada's Safety Code 6 / IC RSS-210. The installer of this device should ensure that RF radiation is not emitted in excess of the Health Canada's requirement. Information can be obtained at: http://www.hc-sc.gc.ca/ewh-semt/pubs/radiation/radio_guide-lignes_direct-eng.php

Cet appareil est conforme avec Santé Canada Code de sécurité 6 / IC RSS-210. Le programme d'installation de cet appareil doit s'assurer que les rayonnements RF n'est pas émis au-delà de l'exigence de Santé Canada. Les informations peuvent être obtenues: http://www.hc-sc.gc.ca/ewh-semt/pubs/radiation/radio_guide-lignes_direct-eng.php

13.5 IC Labeling Requirements

The host device should be properly labeled to identify the module within the host device. The Industry Canada certification label of a module shall be clearly visible at all times when installed in the host device, otherwise the host device must be labeled to display the Industry Canada certification number of the module, preceded by the words "Contains transmitter module", or the word "Contains", or similar wording expressing the same meaning, as follows:

Contains transmitter module IC:4523A-SN2100,
where 4523A-SN2100 is the module's certification number.

13.6 CE Notice (Europe)

This device has been tested and certified for use in the European Union.

If this device is used in a product, the OEM has responsibility to verify compliance of the final product to the EU standards. A Declaration of Conformity must be issued and kept on file as described in Annex II of the Radio and Telecommunications Terminal Equipment Directive.

13.7 CE Labeling Requirements

The 'CE' mark must be placed on the OEM product per the labeling requirements of the Directive. Given that the operating frequency band is not harmonized by a few European countries, the restriction or alert sign must be placed alongside the 'CE' mark as shown below. The restriction is that, if the radio is operated outdoors in the 2450-2483.5 MHz

band, the power must be limited to 10 mW instead of 100 mW. The OEM must account for this and the product must have the alert mark. It does not require country notifications, however.



14 Technical Support Contact

SyChip, LLC
2805 Dallas Parkway, Suite 400
Plano, TX 75093
USA
Tel: (972) 202-8900
Fax: (972) 633-0327

Note: SyChip, LLC is an operating unit within Murata Wireless Solutions

15 Disclaimer

Please read this notice before using the SN2100 product.

1. Please note that the only warranty that SyChip LLC (“SyChip”) provides regarding the products is its conformance to the specifications provided herein. Accordingly, SyChip shall not be responsible for any defects in products or equipment incorporating such products, which are caused under the conditions other than those specified in this specification.

SYCHIP HEREBY DISCLAIMS ALL OTHER WARRANTIES REGARDING THE PRODUCTS, EXPRESS OR IMPLIED, INCLUDING WITHOUT LIMITATION ANY WARRANTY OF FITNESS FOR A PARTICULAR PURPOSE, THAT THEY ARE DEFECT-FREE, OR AGAINST INFRINGEMENT OF INTELLECTUAL PROPERTY RIGHTS. YOU AGREE TO INDEMNIFY AND DEFEND SYCHIP AND ITS AFFILIATES AGAINST ALL CLAIMS, DAMAGES, COSTS AND EXPENSES THAT MAY BE INCURRED, INCLUDING WITHOUT LIMITATION, ATTORNEY FEES AND COSTS, DUE TO THE USE OF PRODUCTS.

2. The product is designed and manufactured for general applications, and not for any particular application, so testing and use of the product shall be conducted at your own risk and responsibility. Specifically, please observe the following:

- i) Please conduct validation and verification of the products in actual condition of mounting and operating environment before commercial shipment of the equipment.

- ii) Please pay attention to minimize any mechanical vibration or shock, not to drop the product or a substrate that contains the product during transportation.
- iii) Since the application of static electricity or overvoltage may cause a defect in the product or deterioration of its reliability, caution must be taken against exposure to any static electricity generated by electrified items such as work benches, soldering irons, tools, carrying containers, etc.
- iv) Caution shall be taken to avoid overstress to the product during and after the soldering process.
- v) Since the applied soldering method may deteriorate the reliability, thorough evaluation is recommended.
- vi) In case the product is to be used in equipment or electric circuit that requires high safety or reliability function or performance, sufficient reliability evaluation checks for safety shall be performed before commercial shipment and moreover, due consideration to install a protective circuit is strongly recommended at customer's design stage. Please provide an appropriate fail-safe function on your product to prevent any damages that may be caused by the abnormal function or the failure of our product.

Notwithstanding the foregoing, the product shall not be used in any application listed below which requires especially high reliability for the prevention of such defect as may directly cause damage to the third party's life, body or property.

- Aircraft equipment
- Aerospace equipment
- Undersea equipment
- Power plant control equipment
- Medical equipment
- Transportation equipment (vehicles, trains, ships, etc.)
- Traffic signal equipment
- Disaster prevention / crime prevention equipment
- Application of similar complexity and/or reliability requirements to the applications listed in the above.

3. SyChip's warranty as provided in Clause 1 above that the products comply with descriptions expressly specified in the specifications shall be effective for a period of six (6) months from the date of delivery. SyChip shall not be liable for any defects that occur in dry packed products that are installed more than six (6) months after shipment.

SyChip's liability under this warranty shall be limited to products that are returned during the warranty period to the address designated by SyChip and that are determined by SyChip not to conform to such warranty. If SyChip elects to repair or replace such products, SyChip shall have reasonable time to repair such products or provide

replacements. Repaired products shall be warranted for the remainder of the original warranty period. Replaced products shall be warranted for a new full warranty period.

For avoidance of doubt, SyChip shall not be liable for any defects that are caused by neglect, misuse or mistreatment by an entity other than SyChip including improper installation or testing, or for any products that have been altered or modified in any way by an entity other than SyChip. Moreover, SyChip shall not be liable for any defects that result from your or third party's design, specifications or instructions for such products.

4. Testing and other quality control techniques are used to the extent SyChip deems necessary. Unless mandated by government requirements, SyChip does not necessarily test all parameters of each product.

5. End of Life - Please note that we may discontinue the manufacture of products, due to reasons such as, but not limited to, end of supply of materials and/or components from our suppliers.