



Fully integrated stepper motor driver mounting the L6470

Data brief — production data

Features

- Voltage range from 8 V to 45 V
- Phase current up to 3 A_{rms}
- SPI with daisy-chain feature
- Socket for external resonator or crystal
- SW input
- FLAG and BUSY LED indicators
- Adjustable supply voltage compensation
- Suitable to be used in combination with STEVAL-PCC009V2

Description

The EVAL6470H demonstration board is a fully integrated microstepping motor driver. In combination with the STEVAL-PCC009V2 communication board and the dSPIN evaluation software, the board allows the user to investigate all the features of the L6470 device. In particular, the board can be used to check the voltage mode driving and to regulate the L6470 parameters in order to fit the application requirements.

The EVAL6470H supports the daisy-chain configuration making it suitable for the evaluation of the L6470 in multi-motor applications.



1 Board description

Table 1. EVAL6470H specifications

Parameter	Value
Supply voltage (VS)	8 to 45 V
Maximum output current (each phase)	3 A _{r.m.s.}
Logic supply voltage (VREG)	Externally supplied: 3.3 V, internally supplied: 3 V (typ.)
Logic interface voltage (VDD)	Externally supplied: 3.3 V or 5 V, internally supplied: VREG
Low level logic inputs voltage	0 V
High level logic input voltage	VDD ⁽¹⁾
Operating temperature	-25 to +125 °C
L6470H thermal resistance junction-to-ambient	21 °C/W (typ.)

1. All logic inputs are 5 V tolerant.

Figure 1. Jumpers and connectors location

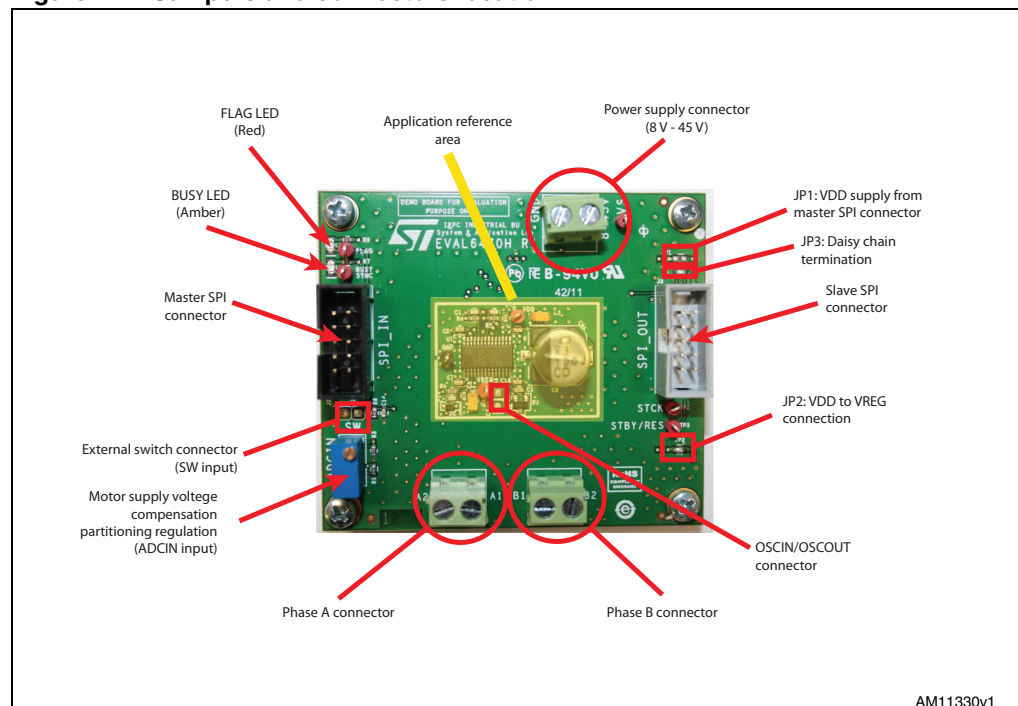

AM11330v1

Table 2. Jumpers and connectors description

Name	Type	Function
J1	Power supply	Motor supply voltage
J5	Power output	Bridge A outputs
J6	Power output	Bridge B outputs
J2	SPI connector	Master SPI
J3	SPI connector	Slave SPI
J4	NM connector	OSCIN and OSCOUT pins
J7	NM connector	External switch input
TP1 (VS)	Test point	Motor supply voltage test point
TP4 (VDD)	Test point	Logic interface supply voltage test point
TP5 (VREG)	Test point	Logic supply voltage/L6470 internal regulator test point
TP6 (GND)	Test point	Ground test point
TP2 (STCK)	Test point	Step clock input test point
TP3 (STBY/RES)	Test point	Standby/reset input test point
TP7 (FLAG)	Test point	FLAG output test point
TP8 (BUSY/SYNC)	Test point	BUSY/SYNC output test point

Table 3. Master SPI connector pinout (J10)

Pin number	Type	Description
1	Open drain output	L6470 BUSY/SYNC output
2	Open drain output	L6470 FLAG output
3	Ground	Ground
4	Supply	EXT_VDD (can be used as external logic power supply)
5	Digital output	SPI Master-In Slave-Out signal (connected to L6470 SDO output through daisy-chain termination jumper JP2)
6	Digital input	SPI serial clock signal (connected to L6470 CK input)
7	Digital input	SPI Master-Out Slave-In signal (connected to L6470 SDI input)
8	Digital input	SPI slave select signal (connected to L6470 CS input)
9	Digital input	L6470 step-clock input
10	Digital input	L6470 STBY/RST input

Table 4. Slave SPI connector pinout (J11)

Pin number	Type	Description
1	Open drain output	L6470 BUSY/SYNC output
2	Open drain output	L6470 FLAG output

Table 4. Slave SPI connector pinout (J11) (continued)

Pin number	Type	Description
3	Ground	Ground
4	Supply	EXT_VDD (can be used as external logic power supply)
5	Digital output	SPI Master-In Slave-Out signal (connected to pin 5 of J10)
6	Digital input	SPI serial clock signal (connected to L6470 CK input)
7	Digital input	SPI Master-Out Slave-In signal (connected to L6470 SDO output)
8	Digital input	SPI slave select signal (connected to L6470 CS input)
9	Digital input	L6470 step-clock input
10	Digital input	L6470 STBY/RST input

Figure 2. EVAL6470H - schematic

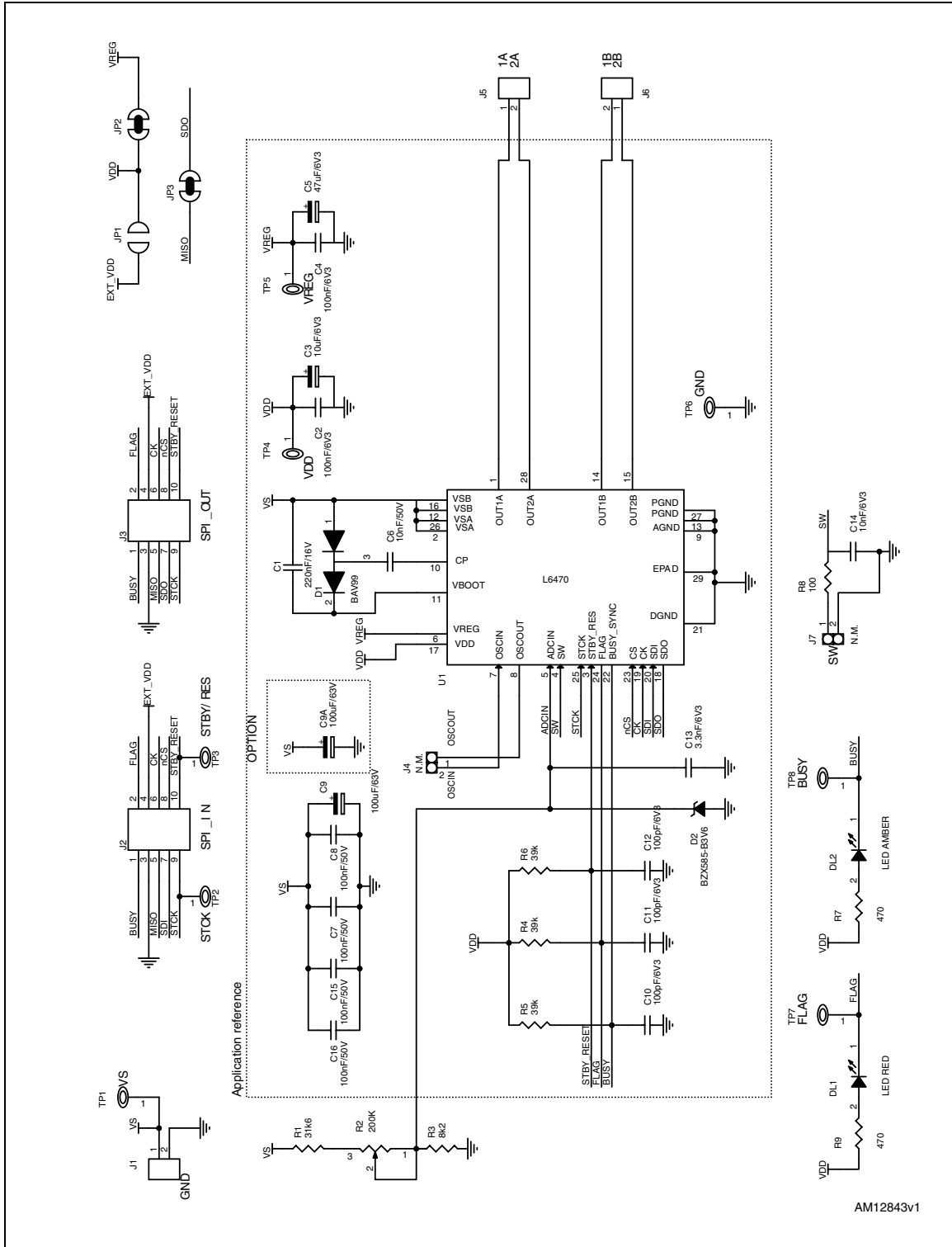

Table 5. EVAL6470H - bill of material

Item	Quantity	Reference	Value	Package
1	1	C1	220 nF/16 V	CAPC-0603
2	2	C2,C4	100 nF/6.3 V	CAPC-0603
3	1	C3	10 μ F/6.3 V	CAPC-3216
4	1	C5	47 μ F/6.3 V	CAPC-3216
5	1	C6	10 nF/50 V	CAPC-0603
6	4	C7,C8,C15,C16	100 nF/50 V	CAPC-0603
7	1	C9A	100 μ F/63 V	CAPE-R8H12-P35
8	1	C9	100 μ F/63 V	CAPE-R10HXX
9	3	C10,C11,C12	100 pF/6.3 V	CAPC-0603
10	1	C13	3.3 nF/6.3 V	CAPC-0603
11	1	C14	10 nF/6.3 V	CAPC-0603
12	1	DL1	LED diode (red)	LEDC-0805
13	1	DL2	LED diode (amber)	LEDC-0805
14	1	D1	BAV99	SOT23
15	1	D2	BZX585-B3V6(1)	SOD523
16	1	JP1	Jumper - OPEN	JP2SO
17	2	JP2,JP3	Jumper - CLOSED	JP2SO
18	3	J1,J5,J6	Screw connector 2 poles	MORSV-508-2P
19	2	J2,J3	Pol. IDC male header vertical 10 poles	CON-FLAT-5X2-180M
20	2	J4,J7	N.M.	STRIP254P-M-2
21	1	R1	31.6 k Ω	RESC-0603
22	1	R2	200 k Ω	TRIMM-100X50X110-64W
23	1	R3	8.2 k Ω	RESC-0603
24	3	R4,R5,R6	39 k Ω	RESC-0603
25	2	R7,R9	470 Ω	RESC-0603
26	1	R8	100 Ω	RESC-0603
27	8	TP1, TP2, TP3, TP4, TP5, TP6, TP7, TP8	Test point	TH
28	1	U1	L6470H	HTSSOP28

Figure 3. EVAL6470H - layout (silk screen)

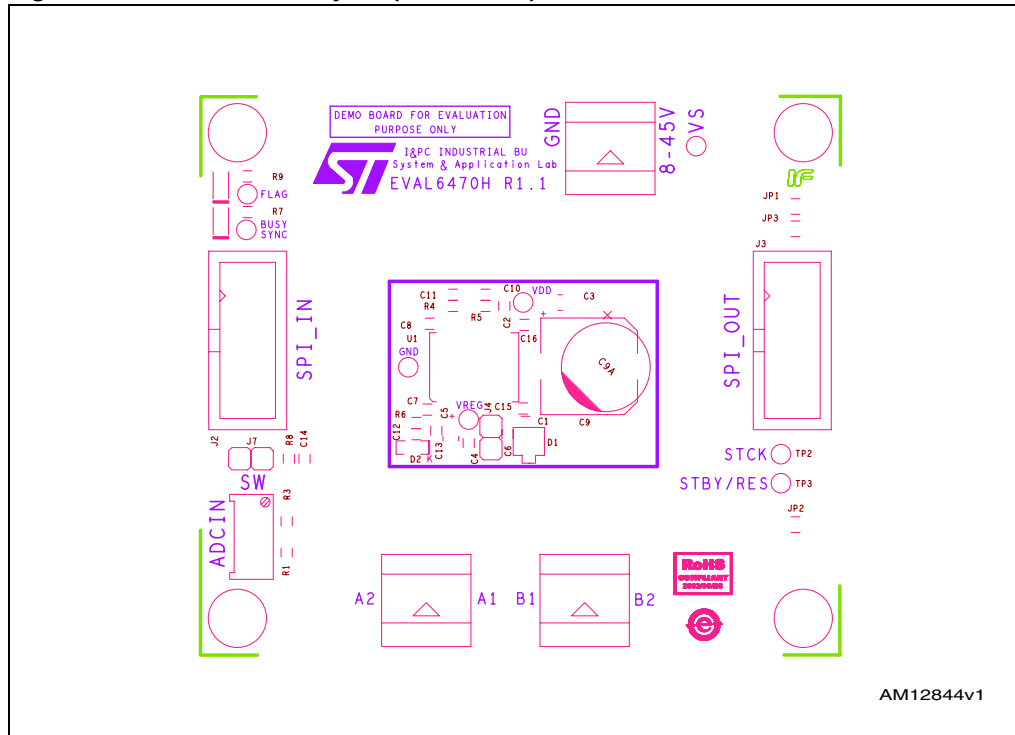

Figure 4. EVAL6470H - layout (top layer)

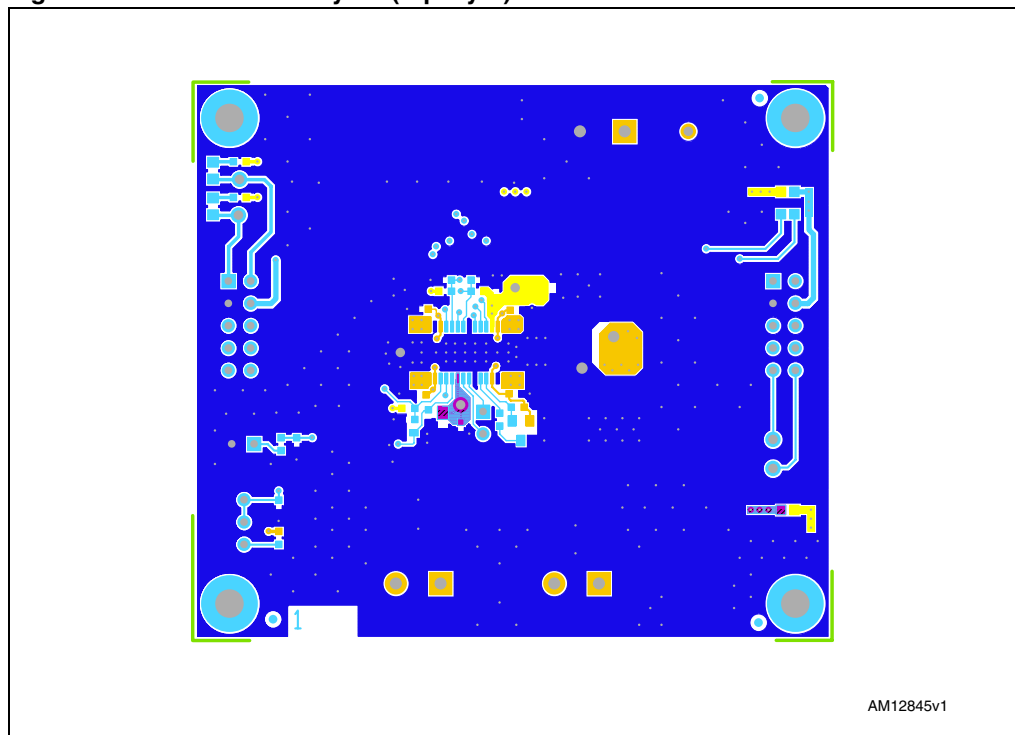

Figure 5. EVAL6470H - layout (inner layer 2)

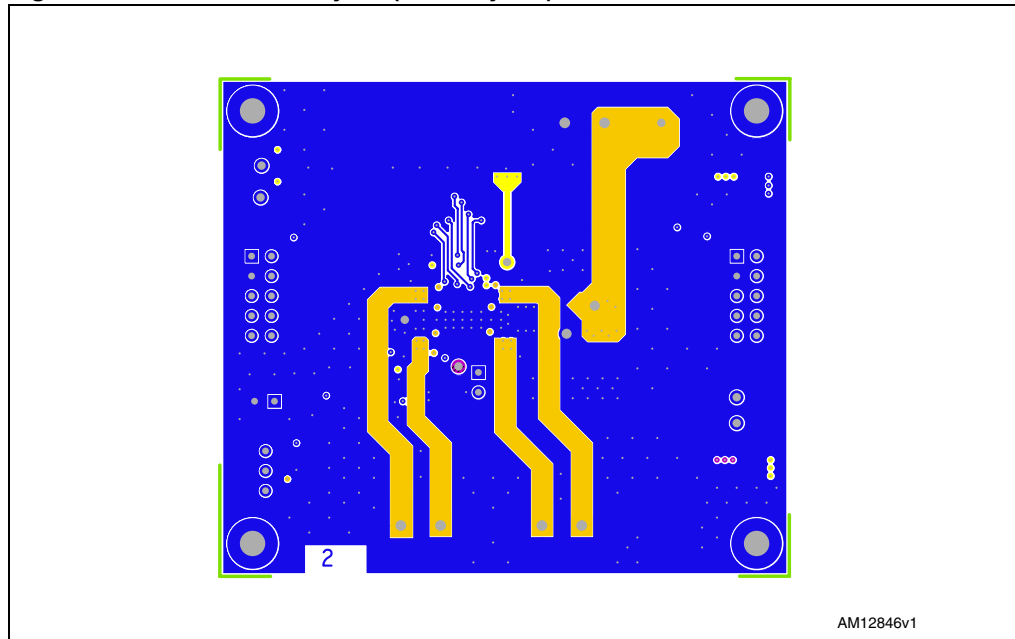

Figure 6. EVAL6470H - layout (inner layer 3)

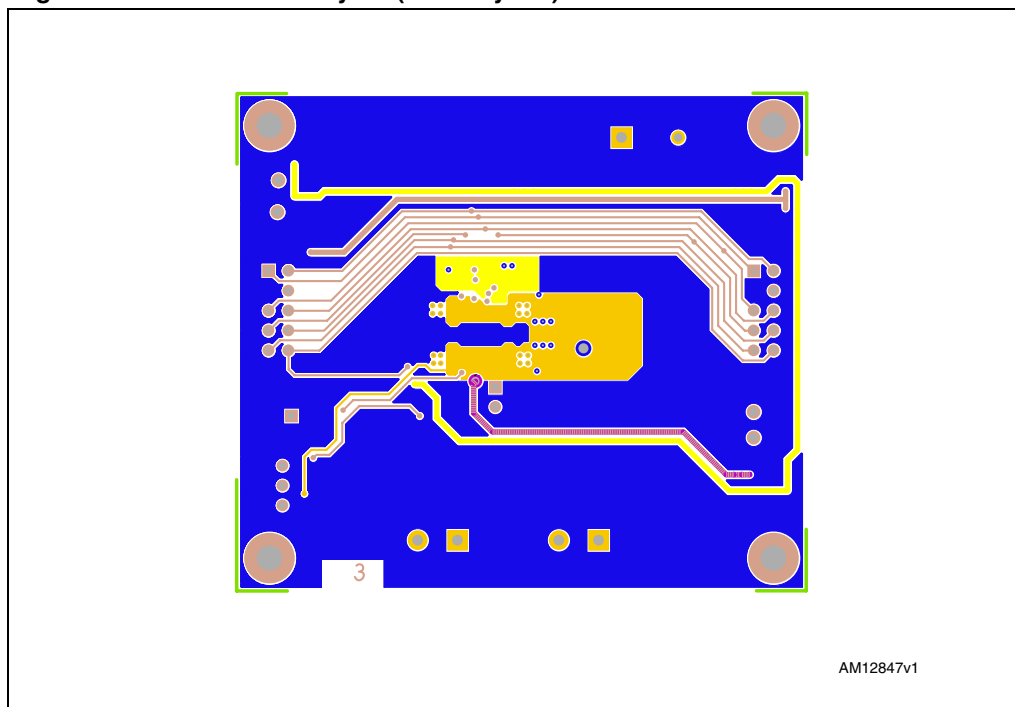
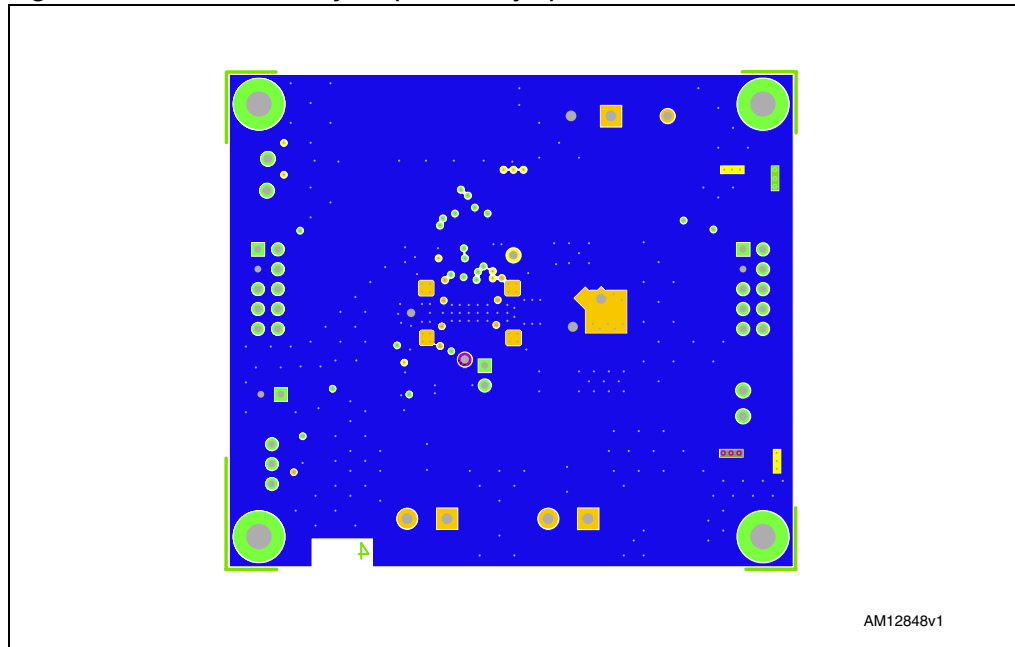
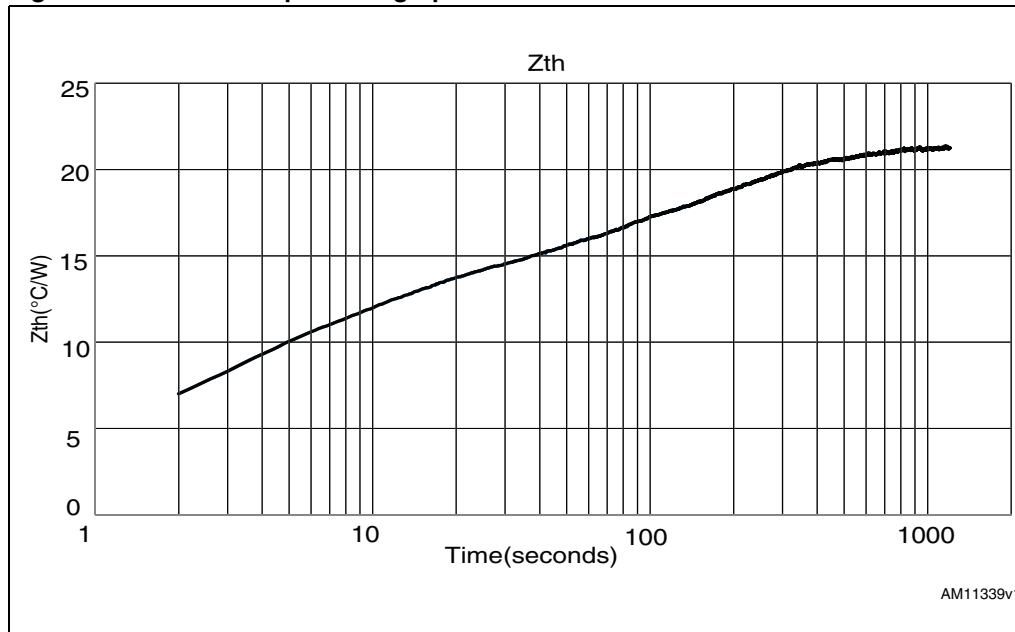

Figure 7. EVAL6470H - layout (bottom layer)



1.1 Thermal data

Figure 8. Thermal impedance graph



2 Revision history

Table 6. Document revision history

Date	Revision	Changes
25-Jan-2012	1	Initial release.
23-Apr-2012	2	Updated information: Table 2 for connector TP3 (STBY/RES). Table 3 , and Table 4 description changed for pin 1 and pin10 Table 5 for item15. Updated: Figure 2 , Figure 3 , Figure 4 , Figure 5 , Figure 6 , and Figure 7 .

Please Read Carefully:

Information in this document is provided solely in connection with ST products. STMicroelectronics NV and its subsidiaries ("ST") reserve the right to make changes, corrections, modifications or improvements, to this document, and the products and services described herein at any time, without notice.

All ST products are sold pursuant to ST's terms and conditions of sale.

Purchasers are solely responsible for the choice, selection and use of the ST products and services described herein, and ST assumes no liability whatsoever relating to the choice, selection or use of the ST products and services described herein.

No license, express or implied, by estoppel or otherwise, to any intellectual property rights is granted under this document. If any part of this document refers to any third party products or services it shall not be deemed a license grant by ST for the use of such third party products or services, or any intellectual property contained therein or considered as a warranty covering the use in any manner whatsoever of such third party products or services or any intellectual property contained therein.

UNLESS OTHERWISE SET FORTH IN ST'S TERMS AND CONDITIONS OF SALE ST DISCLAIMS ANY EXPRESS OR IMPLIED WARRANTY WITH RESPECT TO THE USE AND/OR SALE OF ST PRODUCTS INCLUDING WITHOUT LIMITATION IMPLIED WARRANTIES OF MERCHANTABILITY, FITNESS FOR A PARTICULAR PURPOSE (AND THEIR EQUIVALENTS UNDER THE LAWS OF ANY JURISDICTION), OR INFRINGEMENT OF ANY PATENT, COPYRIGHT OR OTHER INTELLECTUAL PROPERTY RIGHT.

UNLESS EXPRESSLY APPROVED IN WRITING BY TWO AUTHORIZED ST REPRESENTATIVES, ST PRODUCTS ARE NOT RECOMMENDED, AUTHORIZED OR WARRANTED FOR USE IN MILITARY, AIR CRAFT, SPACE, LIFE SAVING, OR LIFE SUSTAINING APPLICATIONS, NOR IN PRODUCTS OR SYSTEMS WHERE FAILURE OR MALFUNCTION MAY RESULT IN PERSONAL INJURY, DEATH, OR SEVERE PROPERTY OR ENVIRONMENTAL DAMAGE. ST PRODUCTS WHICH ARE NOT SPECIFIED AS "AUTOMOTIVE GRADE" MAY ONLY BE USED IN AUTOMOTIVE APPLICATIONS AT USER'S OWN RISK.

Resale of ST products with provisions different from the statements and/or technical features set forth in this document shall immediately void any warranty granted by ST for the ST product or service described herein and shall not create or extend in any manner whatsoever, any liability of ST.

ST and the ST logo are trademarks or registered trademarks of ST in various countries.

Information in this document supersedes and replaces all information previously supplied.

The ST logo is a registered trademark of STMicroelectronics. All other names are the property of their respective owners.

© 2012 STMicroelectronics - All rights reserved

STMicroelectronics group of companies

Australia - Belgium - Brazil - Canada - China - Czech Republic - Finland - France - Germany - Hong Kong - India - Israel - Italy - Japan - Malaysia - Malta - Morocco - Philippines - Singapore - Spain - Sweden - Switzerland - United Kingdom - United States of America

www.st.com

