

**SURFACE MOUNT  
GLASS PASSIVATED SILICON RECTIFIER  
VOLTAGE RANGE 50 to 1000 Volts CURRENT 1.0 Ampere**

**FEATURES**

- \* Glass passivated device
- \* Ideal for surface mounted applications
- \* Low leakage current
- \* Metallurgically bonded construction
- \* Mounting position: Any
- \* Weight: 0.015 gram

**MECHANICAL DATA**

- \* Epoxy : Device has UL flammability classification 94V-0

**DISCONTINUED-**

"This series is replaced by the FM400X series that meets to the same fit and function parameters and share the same solder pad layout. The FM400X series is preferred for error-free vacuum pick-up and PCB assembly."

**MAXIMUM RATINGS AND ELECTRICAL CHARACTERISTICS**

Ratings at 25°C ambient temperature unless otherwise specified.  
Single phase, half wave, 60 Hz, resistive or inductive load.  
For capacitive load, derate current by 20%.

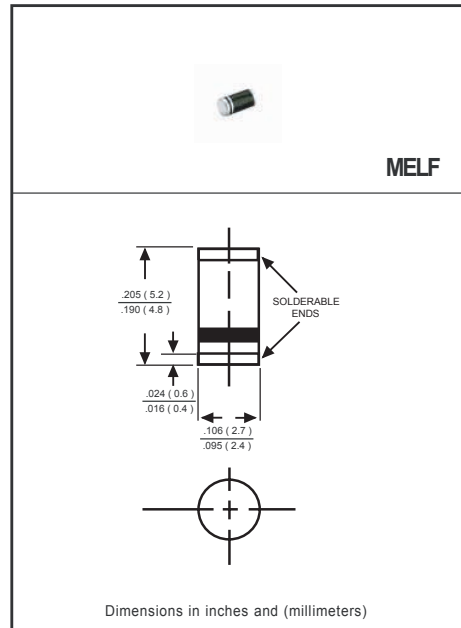

**MAXIMUM RATINGS (@TA=25 °C unless otherwise noted)**

RATINGS	SYMBOL	SM4001	SM4002	SM4003	SM4004	SM4005	SM4006	SM4007	UNITS
Maximum Recurrent Peak Reverse Voltage	V <sub>RRM</sub>	50	100	200	400	600	800	1000	Volts
Maximum RMS Voltage	V <sub>RMS</sub>	35	70	140	280	420	560	700	Volts
Maximum DC Blocking Voltage	V <sub>DC</sub>	50	100	200	400	600	800	1000	Volts
Maximum Average Forward Rectified Current at Ambient Temperature	I <sub>O</sub>	1.0							Amps
Peak Forward Surge Current 8.3 ms single half sine-wave superimposed on rated load (JEDEC method)	I <sub>FSM</sub>	30							Amps
Typical Thermal Resistance (Note 1)	R <sub>θJA</sub>	50							°C/W
Typical Thermal Resistance (Note 1)	R <sub>θJC</sub>	20							°C/W
Typical Junction Capacitance (Note 2)	C <sub>J</sub>	15							pF
Operating Temperature Range	T <sub>J</sub>	150							°C
Storage Temperature Range	T <sub>STG</sub>	-55 to + 150							°C

**ELECTRICAL CHARACTERISTICS(@TA=25 °C unless otherwise noted)**

CHARACTERISTICS	SYMBOL	SM4001	SM4002	SM4003	SM4004	SM4005	SM4006	SM4007	UNITS
Maximum Instantaneous Forward Voltage at 1.0A DC	V <sub>F</sub>	1.1							Volts
Maximum Average Reverse Current at Rated DC Blocking Voltage	@T <sub>A</sub> = 25°C	5.0							uA
	@T <sub>A</sub> = 100°C	100							uA

- NOTES : 1. Thermal Resistance :Mounted on PCB.  
2. Measured at 1 MHz and applied reverse voltage of 4.0 volts.  
3. "Fully ROHS compliant", "100% Sn plating (Pb-free)".

## RATING AND CHARACTERISTICS CURVES ( SM4001 THRU SM4007 )

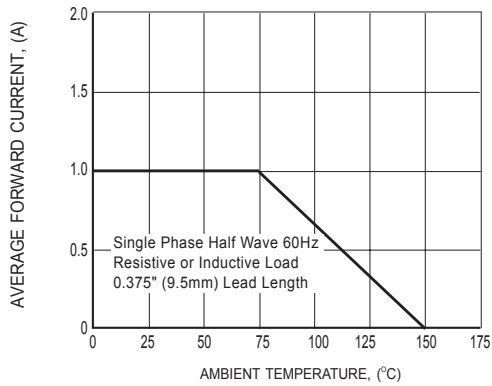

FIG.1 TYPICAL FORWARD CURRENT DERATING CURVE

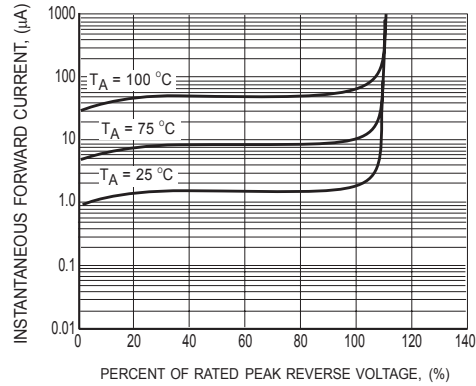

FIG.2 TYPICAL REVERSE CHARACTERISTICS

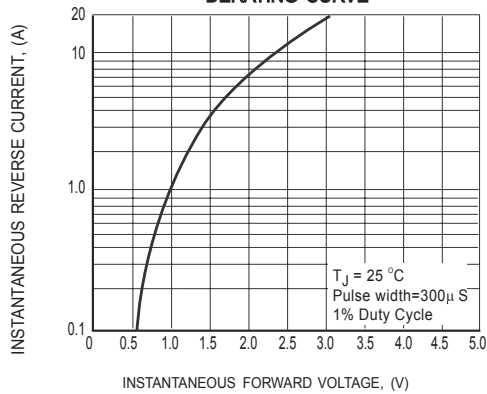

FIG.3 TYPICAL INSTANTANEOUS FORWARD CHARACTERISTICS

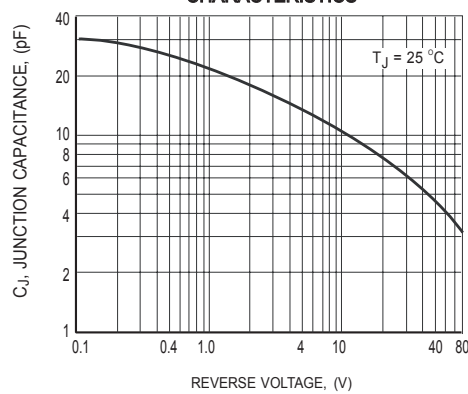

FIG.4 TYPICAL JUNCTION CAPACITANCE

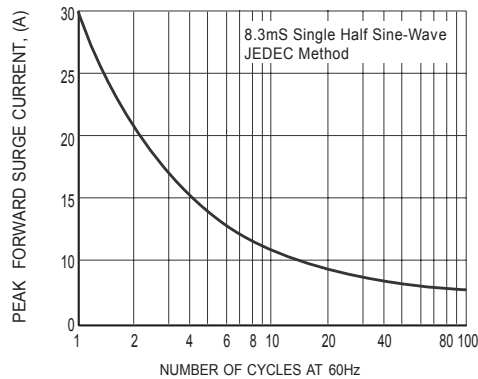
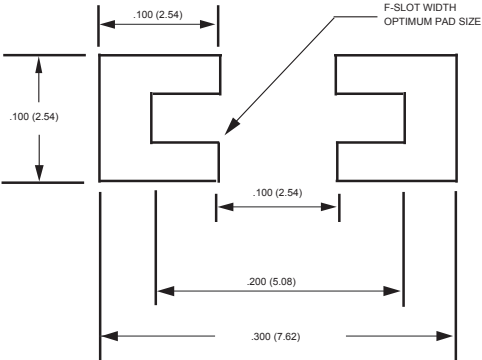

FIG.5 MAXIMUM NON-REPETITIVE FORWARD SURGE CURRENT

# Mounting Pad Layout



Dimensions in inches and (millimeters)



## DISCLAIMER NOTICE

Rectron Inc reserves the right to make changes without notice to any product specification herein, to make corrections, modifications, enhancements or other changes. Rectron Inc or anyone on its behalf assumes no responsibility or liability for any errors or inaccuracies. Data sheet specifications and its information contained are intended to provide a product description only. "Typical" parameters which may be included on RECTRON data sheets and/ or specifications can and do vary in different applications and actual performance may vary over time. Rectron Inc does not assume any liability arising out of the application or use of any product or circuit.

Rectron products are not designed, intended or authorized for use in medical, life-saving implant or other applications intended for life-sustaining or other related applications where a failure or malfunction of component or circuitry may directly or indirectly cause injury or threaten a life without expressed written approval of Rectron Inc. Customers using or selling Rectron components for use in such applications do so at their own risk and shall agree to fully indemnify Rectron Inc and its subsidiaries harmless against all claims, damages and expenditures.

