

GLASS PASSIVATED SUPER FAST RECTIFIER

VOLTAGE RANGE 50 to 600 Volts CURRENT 1.0 Ampere

FEATURES

- * High reliability
- * Low leakage
- * Low forward voltage
- * High current capability
- * Super fast switching speed
- * High surge capability
- * Good for switching mode circuit

MECHANICAL DATA

- * Case: Molded plastic
- * Epoxy: Device has UL flammability classification 94V-O
- * Lead: MIL-STD-202E method 208C guaranteed
- * Mounting position: Any
- * Weight: 0.33 gram

MAXIMUM RATINGS AND ELECTRICAL CHARACTERISTICS

Ratings at 25 °C ambient temperature unless otherwise specified.
Single phase, half wave, 60 Hz, resistive or inductive load.
For capacitive load, derate current by 20%.

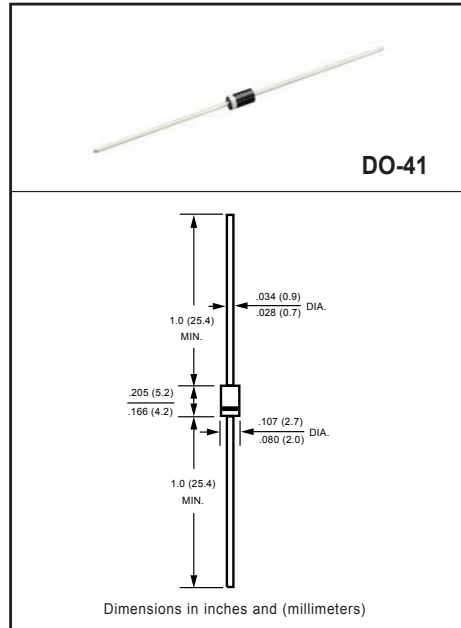

MAXIMUM RATINGS (@ TA=25 °C unless otherwise noted)

RATINGS	SYMBOL	SF11	SF12	SF13	SF14	SF15	SF16	SF17	UNITS	
Maximum Recurrent Peak Reverse Voltage	V _{RRM}	50	100	150	200	300	400	600	Volts	
Maximum RMS Voltage	V _{RMS}	35	70	105	140	210	280	420	Volts	
Maximum DC Blocking Voltage	V _{DC}	50	100	150	200	300	400	600	Volts	
Maximum Average Forward Rectified Current at T _A = 55°C	I _O	1.0							Amps	
Peak Forward Surge Current 8.3 ms single half sine-wave superimposed on rated load (JEDEC method)	I _{FSM}	30							Amps	
Typical Thermal Resistance (Note 3)	R _{θJA}	50							°C/W	
	R _{θJL}	20								
Typical Junction Capacitance (Note 2)	C _J	15				10				pF
Operating and Storage Temperature Range	T _J , T _{STG}	-55 to + 150							°C	

ELECTRICAL CHARACTERISTICS (@ TA=25 °C unless otherwise noted)

CHARACTERISTICS	SYMBOL	SF11	SF12	SF13	SF14	SF15	SF16	SF17	UNITS	
Maximum Instantaneous Forward Voltage at 1.0A DC	V _F	0.95				1.25		1.50		Volts
Maximum DC Reverse Current at Rated DC Blocking Voltage	I _R	@ T _A = 25°C				5.0				μAmps
		@ T _A = 100°C				100				
Maximum Reverse Recovery Time (Note 1)	t _{rr}	35				50				nSec

- NOTES : 1. Test Conditions: I_F = 0.5A, I_R = -1.0A, I_{RR} = -0.25A
 2. Measured at 1 MHz and applied reverse voltage of 4.0 volts.
 3. Typical Thermal Resistance : At 9.5mm lead lengths, PCB mounted.
 4. "Fully ROHS compliant", "100% Sn plating (Pb-free)"

2006-11
REV:B

RATING AND CHARACTERISTICS CURVES (SF11 THRU SF17)

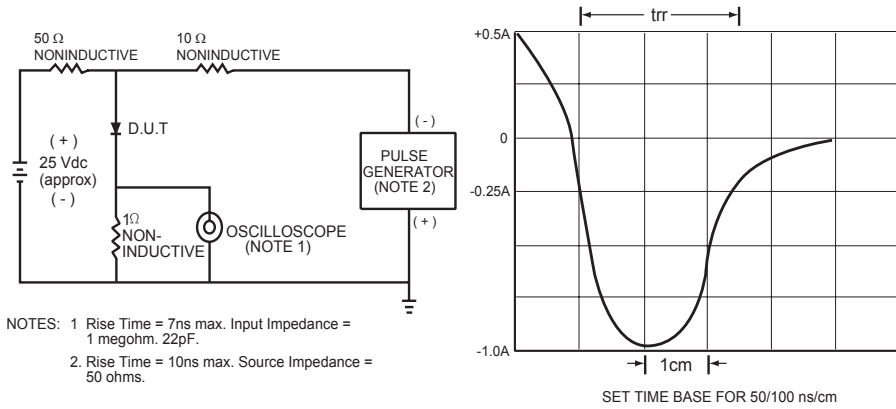

FIG.1 TEST CIRCUIT DIAGRAM AND REVERSE RECOVERY TIME CHARACTERISTIC

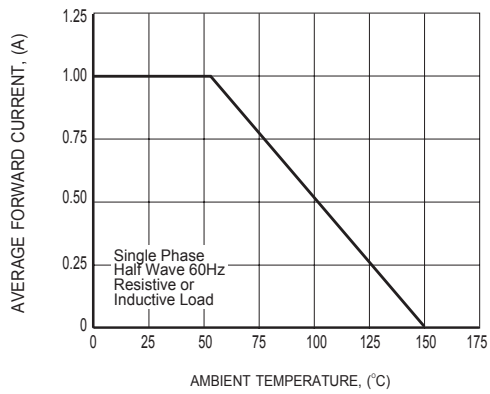

FIG.2 TYPICAL FORWARD CURRENT DERATING CURVE

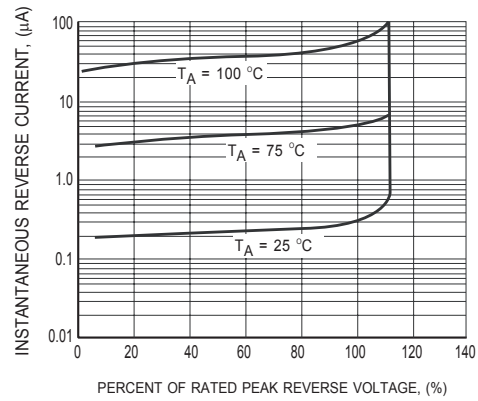

FIG.3 TYPICAL REVERSE CHARACTERISTICS

RATING AND CHARACTERISTICS CURVES (SF11 THRU SF17)

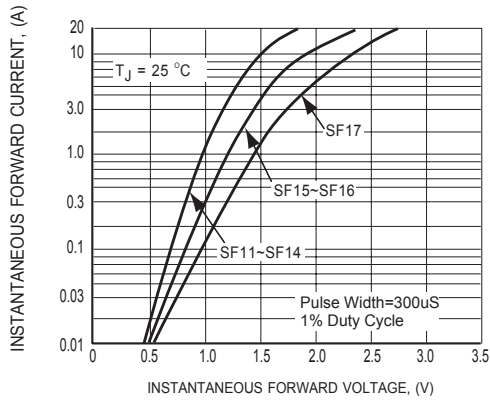

FIG.4 TYPICAL INSTANTANEOUS FORWARD CHARACTERISTICS

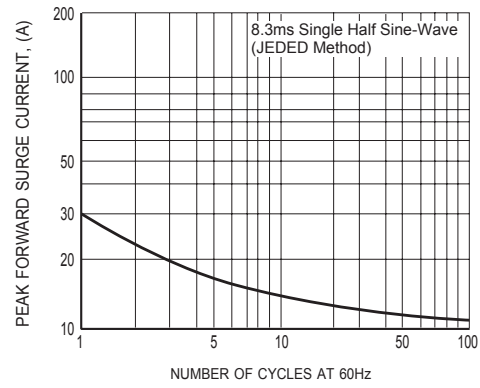

FIG.5 MAXIMUM NON-REPETITIVE FORWARD SURGE CURRENT

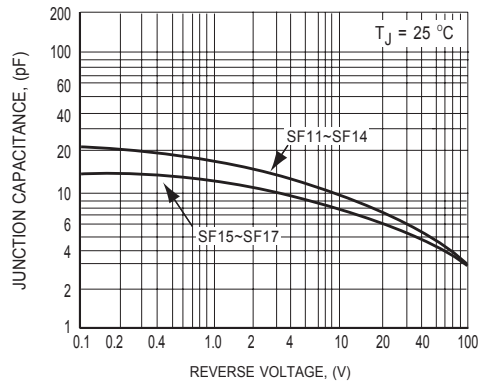

FIG.6 TYPICAL JUNCTION CAPACITANCE

DISCLAIMER NOTICE

Rectron Inc reserves the right to make changes without notice to any product specification herein, to make corrections, modifications, enhancements or other changes. Rectron Inc or anyone on its behalf assumes no responsibility or liability for any errors or inaccuracies. Data sheet specifications and its information contained are intended to provide a product description only. "Typical" parameters which may be included on RECTRON data sheets and/ or specifications can and do vary in different applications and actual performance may vary over time. Rectron Inc does not assume any liability arising out of the application or use of any product or circuit.

Rectron products are not designed, intended or authorized for use in medical, life-saving implant or other applications intended for life-sustaining or other related applications where a failure or malfunction of component or circuitry may directly or indirectly cause injury or threaten a life without expressed written approval of Rectron Inc. Customers using or selling Rectron components for use in such applications do so at their own risk and shall agree to fully indemnify Rectron Inc and its subsidiaries harmless against all claims, damages and expenditures.

