

High Bright LED Driver IC Demoboard Meeting Automotive Requirements

General Description

The HV9930DB1 is an LED driver demoboard capable of driving up to 7 1-watt LEDs in series from an automotive input of 9 - 16VDC. The demoboard uses Supertex's HV9930 in a boost-buck topology. The converter operates at frequencies in excess of 300kHz and has excellent output current regulation over the input voltage range. It can also withstand transients up to 42V and operate down to 6V input. The converter is also protected against open LED and output short circuit conditions. Protection against reverse polarity up to 20V is also included.

Specifications

Parameter	Value
Input voltage (steady state):	9.0VDC - 16VDC
Input voltage (transient):	42VDC
Output LED string voltage:	28V max
Output current:	350mA +/-5%
Output current ripple:	5% typical
Switching frequency:	300kHz (9.0V input) 430kHz (13.5V input) 500kHz (16.0V input)
Efficiency:	80% (at 13.5V input)
Open LED protection:	Included; clamps output voltage at 33V
Output short circuit protection:	Included; limits current at 350mA
Reverse polarity protection:	-20V max
Input current limit:	1.9A
PWM dimming frequency:	Up to 1.0kHz
Conducted EMI:	Meets SAE J1113 conducted EMI standards

Board Layout and Connection Diagram



Actual Size: 2.25" x 1.25"

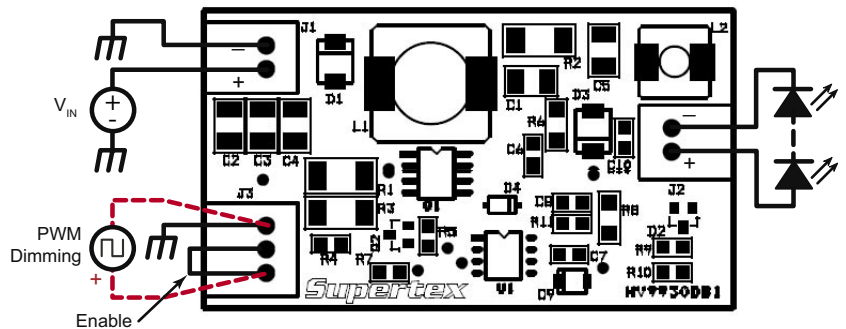

Connections:

Input - The input is connected between the terminals of connector J1 as shown in the Connection Diagram.

square wave source between terminals 1 and 3 of connector J3 as shown by the dotted lines.

Output - The output is connected between the terminals of connector J2 as shown.

Note:

During PWM dimming, pin 2 of connector J3 should be left open. Also, the PWM signal must have the proper polarity with the positive connected to pin 1 of J3. Note that pin 3 of J3 is internally connected to the return path of the input voltage.

Enable/PWM Dimming:

To just enable the board, short pins 1 and 2 of connector J3 as shown. For PWM dimming, connect the external push-pull

Testing the Demo Board

Normal Operation: Connect the input source and the output LEDs as shown in the Connection Diagram and enable the board. The LEDs will glow with a steady intensity. Connecting an ammeter in series with the LEDs will allow measurement of the LED current. The current will be 350mA +/- 5%.

Open LED test: Connect a voltmeter across the output terminals of the HV9930DB1. Start the demoboard normally, and once the LED current reaches steady state, unplug one end of the LED string from the demoboard. The output voltage will rise to about 33V and stabilize.

Short Circuit Test: When the HV9930DB1 is operating in steady state, connect a jumper across the terminals of the LED string. Notice that the switching frequency drops, but the average output current remains the same.

PWM Dimming: With the input voltage to the board disconnected, apply a TTL compatible, push-pull square wave signal between PWMD and GND terminals of connector J3 as shown in the Connection Diagram. Turn the input voltage back on and adjust the duty cycle and / or frequency of the PWM dimming signal. The output current will track the PWM dimming signal. Note that although the converter operates perfectly well at 1.0kHz PWM dimming frequency, the best PWM dimming ratios can be obtained at lower frequencies like 100 or 200Hz

Typical Results

Fig. 1 shows the efficiency plot for the HV9930DB1 over the input voltage range. The converter has efficiencies greater than 80% over 13V input. Note that these measurements do not include the 0.3 - 0.5W loss in the reverse blocking diode.

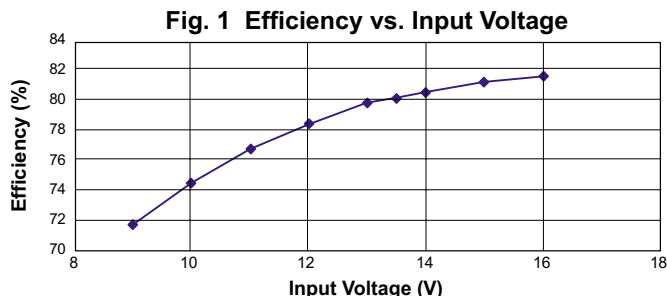

Fig. 2 shows the variation of the switching frequency over the input voltage range. The frequency varies from 300kHz to 500kHz over the entire input voltage range and avoids the restricted frequency band of 150kHz to 300kHz and the AM band greater than 530kHz. This makes it easier to meet the conducted and radiated EMI specifications for the automotive industry.

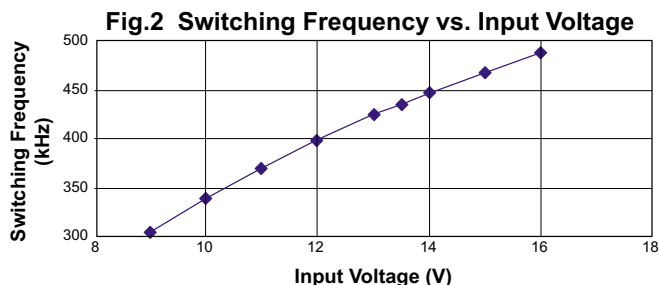
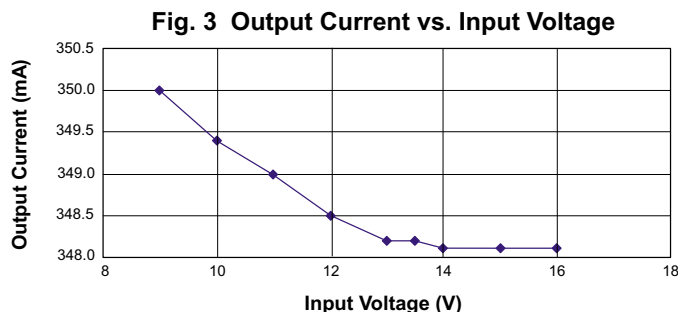

Fig.3 shows the output current variation over the input voltage range. The LED current has a variation of about 2.0mA over the entire voltage range.



The waveforms in Fig.4 show the drain voltage of the FET (channel 1 (blue); 10V/div) and the LED current (channel 4 (green); 100mA/div) at three different operating conditions – 9.0V in, 13.5V in and 16V in.

Fig. 4. Steady State Waveforms

(a): 9.0V in; (b): 13.5V in; (c): 16V in

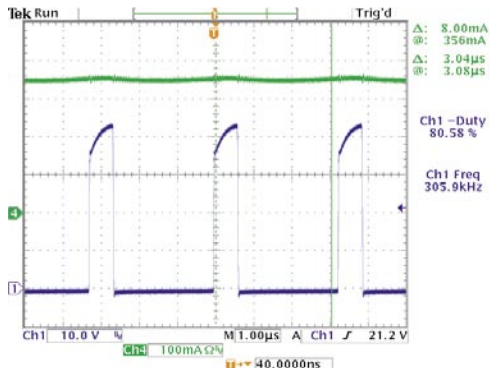

(a)

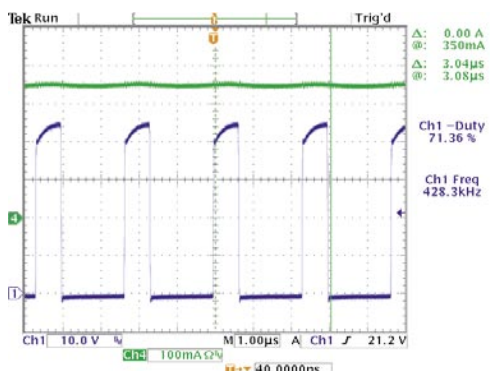

(b)

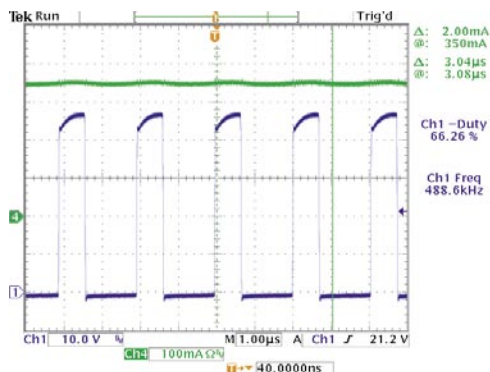

(c)

Fig. 5 shows the operation of the converter during cold crank conditions as the input voltage decreases from 13.5V to 6V and increases back to 13.5V. In these cases, the input current reaches the limit set and the output current drops correspondingly. Thus, the LEDs continue to glow, but with reduced intensity. Once the voltage ramps back up, the output current goes back to its normal value and the converter comes out of the input current limit.

Fig. 5. Cold Crank Operation

Channel 1 (blue): Input voltage (10V/div)
Channel 3 (pink): Input current (1A/div)
Channel 4 (green): LED current; 100mA/div

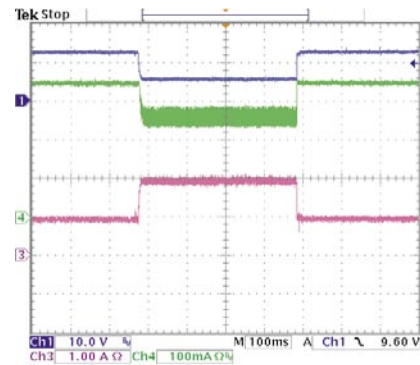

Fig.6 shows the LED current during an input step change from 13.5 to 42V and back to 13.5V (similar to a clamped load dump). It can be seen that the LED current drops briefly when the input voltage jumps, but there are no overshoots.

Fig. 6 LED current during step changes in the input voltage

Channel 1 (blue): Input voltage (10V/div)
Channel 4 (green): LED current (100mA/div)

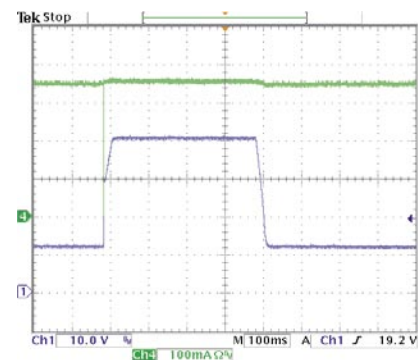

Fig. 7a shows the operation of the converter during an Open LED condition and Fig. 7b shows the operation during output short circuit condition. In both cases, it can be seen that the HV9930DB1 can easily withstand faults and come back into normal operation almost instantly.

Fig. 7 HV9930DB1 during output fault conditions

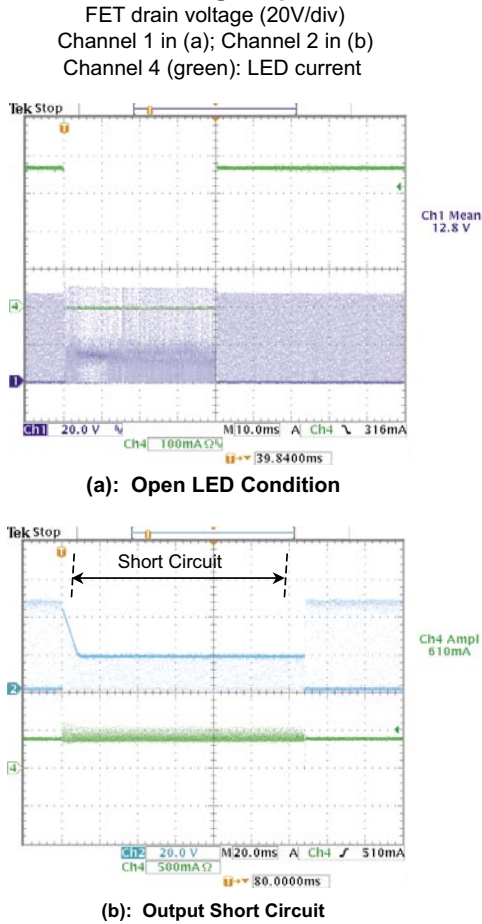

Fig. 8 shows the PWM dimming performance of the HV9930DB1 with a 100Hz, 3.3V square wave signal. The converter can easily operate at PWM dimming duty cycles from 1% - 99%.

Fig. 8 PWM Dimming at 100Hz

Channel 1 (blue): PWM Dimming Input Signal (2V/div)
 Channel 4 (Green): LED current (100mA/div)

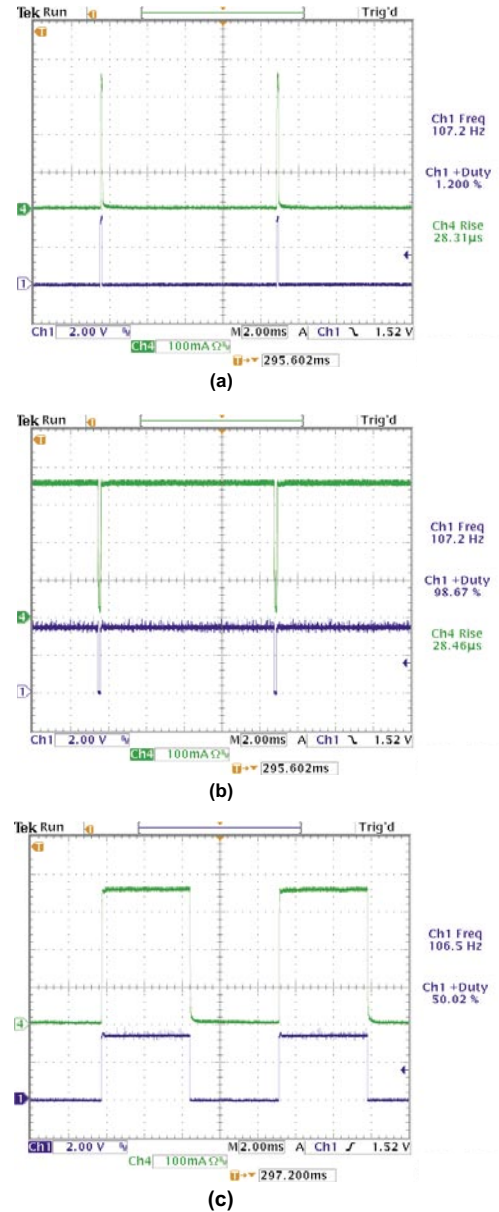
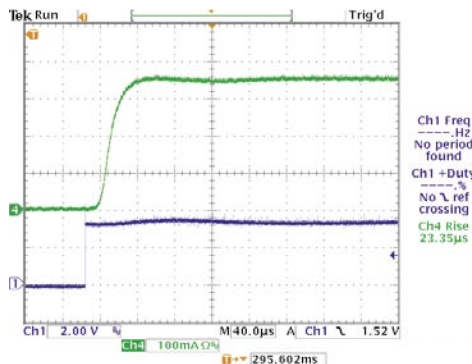

Fig. 9 shows the rise and fall times of the output current during PWM dimming. The converter has nearly symmetric rise and fall times of about 25 μ s. These rise and fall times can be reduced (if desired) by reducing the output capacitance C10. However, this will lead to increased ripple in the output current.

Fig. 9. PWM Dimming rise and fall times

Channel 1 (blue): PWM Dimming Input Signal (2V/div)
Channel 4 (Green): LED current (100mA/div)



(a): rise time

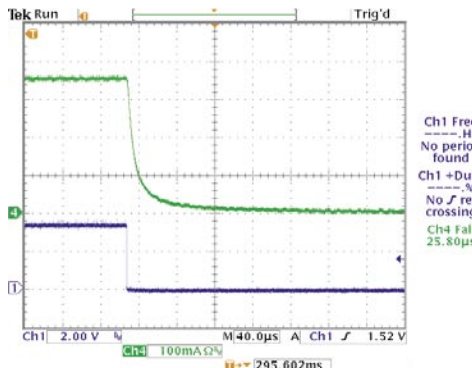

(b): fall time

Conducted EMI Tests on the HV9930DB1

In preliminary tests conducted on the demo board, the board meets SAE J1113 Class 3 conducted EMI standards without the need for any input filters (other than the input capacitors already included). This is a result of the combination of the continuous input current and a localized switching loop (Q1 – C1 – D3).

Table 1 details the conducted EMI limit as per SAE J1113 and the maximum conducted EMI obtained from measurements on the board. The table also lists the Class of the SAE standard the board meets in each frequency range.

The conducted EMI plots for the HV9930DB1 obtained at an input voltage of 13.5V and an LED string voltage of 27V (output current is 350mA) are given in the Appendix.

Table 1. Conducted EMI Measurements

Frequency Range (kHz)	Conducted EMI Limit for Class 3 (dB μ V)	Conducted EMI by HV9930DB1 (dB μ V)	Class as per SAE J1113
150 - 300	70 (narrowband)	40	Class 5
530 - 2.0	50 (narrowband)	48	Class 3
5.9 - 6.2	45 (narrowband)	29	Class 5
30 - 54z	65 (broadband)	54	Class 4
70 - 108	49 (broadband)	47	Class 3

Circuit Schematic:

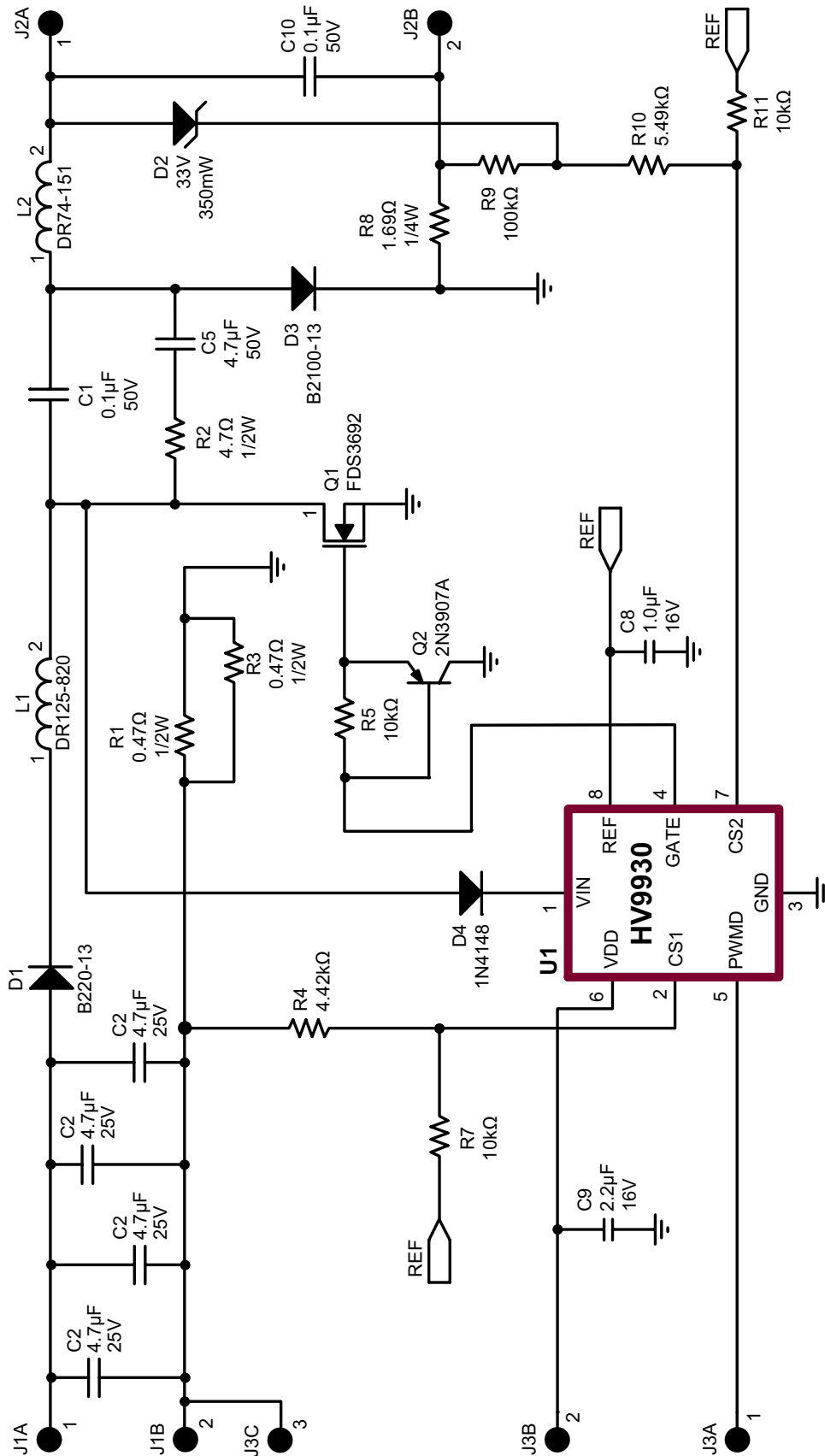

PCB Top Layer

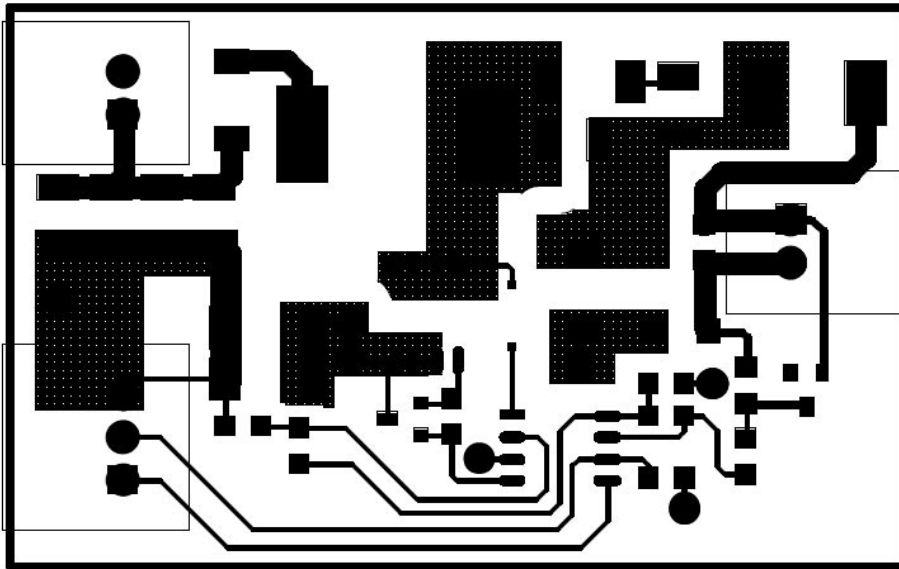

PCB Bottom Layer



Appendix – Conducted EMI Test Results

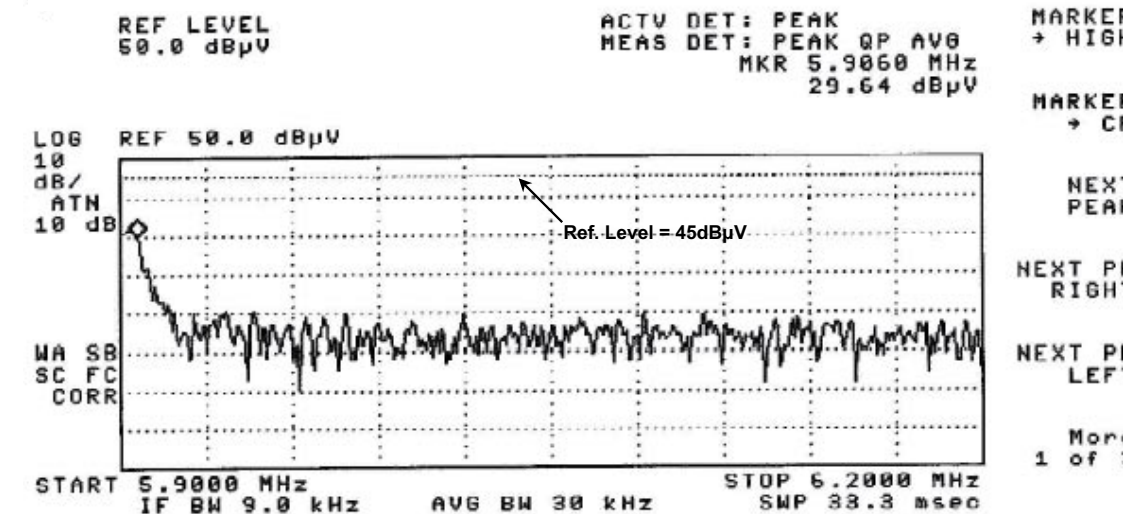
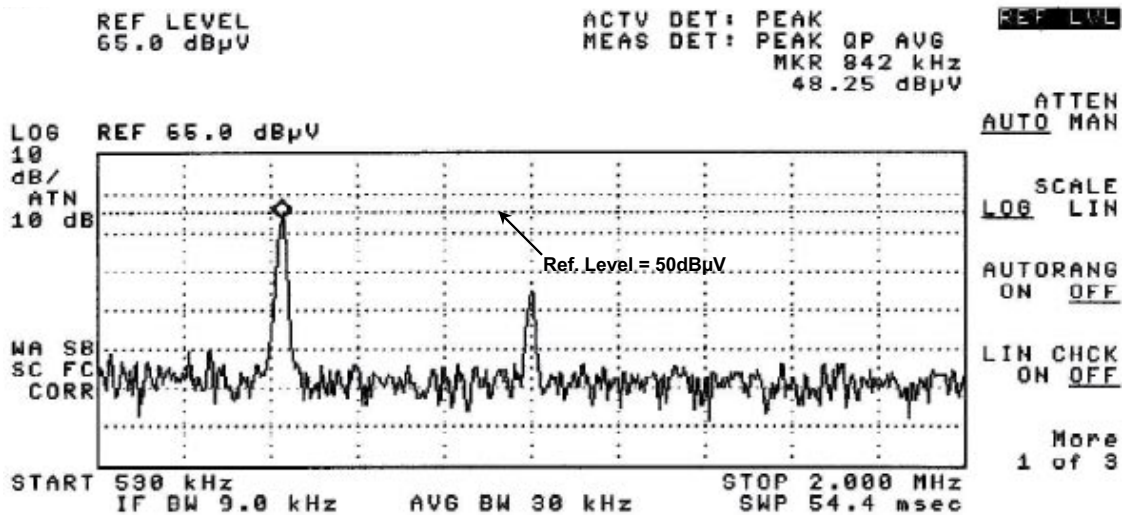
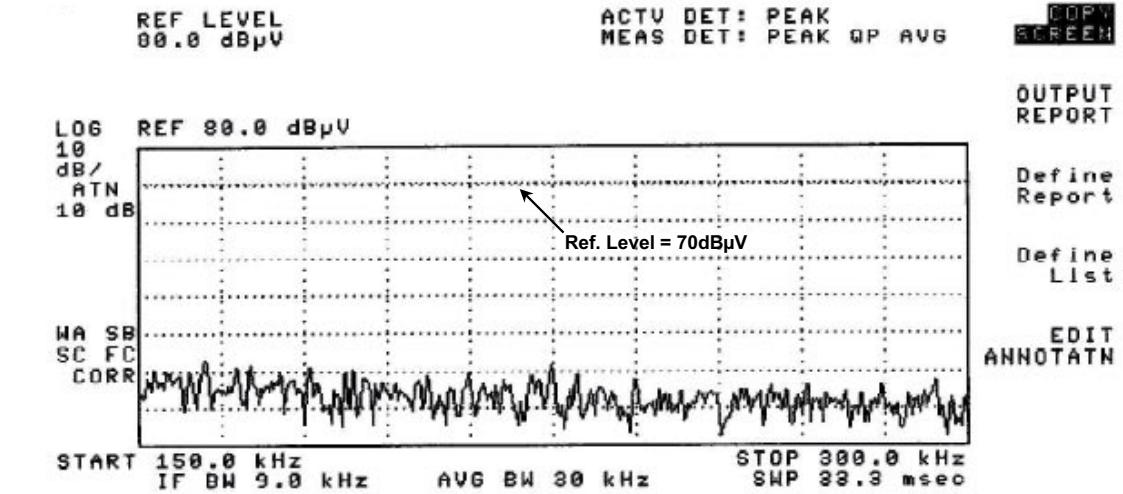

Appendix – Conducted EMI Test Results (cont.)

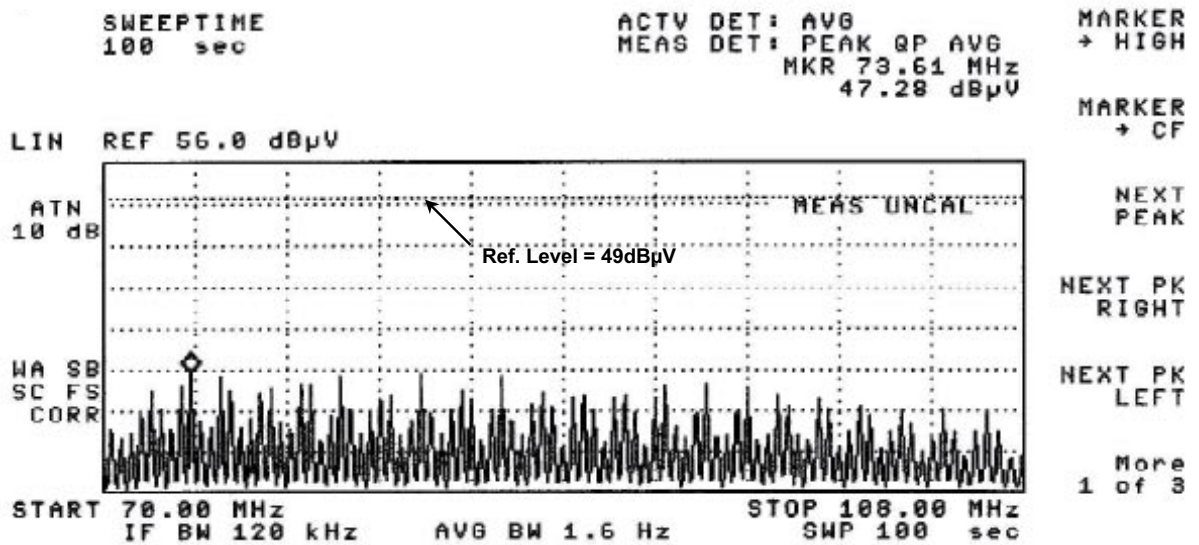
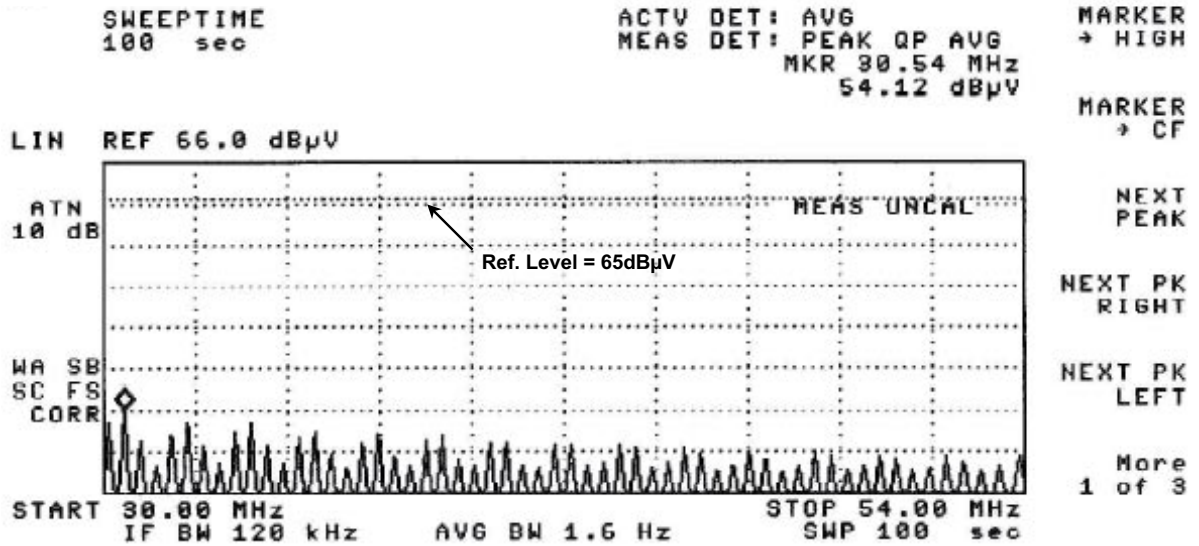

Bill of Materials

#	Quan	Ref Des	Description	Package	Manufacturer	Manufacturer's Part #
1	1	C1	0.22 μ F, 50V X7R ceramic capacitor	SMD1210	Kemet	C1210C224K5RACTU
2	3	C2, C3, C4, C6	4.7 μ F, 25V X5R ceramic capacitor	SMD1210	Panasonic	ECJ-4YB1E475K
3	1	C5	4.7 μ F, 50V X7R ceramic capacitor	SMD1210	Murata	GRM32ER71H475KA88L
4	1	C8	1 μ F, 16V X7R ceramic capacitor	SMD0805	Kemet	C0805C105K4RACTU
5	1	C9	2.2 μ F, 16V X7R ceramic capacitor	SMD0805	TDK Corp.	C2012X7R1C225K
6	1	C10	0.1 μ F, 50V X7R ceramic capacitor	SMD0805	Yageo	08052R104K9B20D
7	1	D1	20V, 2A schottky diode	SMB	Diodes Inc.	B220-13
8	1	D2	33V, 350mW zener diode	SOT-23	Zetex Inc.	BZX84C33-7
9	1	D3	75V, 400mW switching diode	SOD123	Diodes Inc.	1N4148W-7
10	1	D4	100V, 2A schottky diode	SMB	Diodes Inc.	B2100-13
11	2	J1, J2	2 pin, 2.5mm pitch right angle connector	Thru-Hole	JST Sales	S2B-EH
12	1	J3	3 pin, 2.5mm pitch right angle connector	Thru-Hole	JST Sales	S3B-EH
13	1	L1	82 μ H, 2A rms, 2.4A sat inductor	SMT	Coiltronics	DR125-820
14	1	L2	150 μ H, 0.86A rms, 1A sat inductor	SMT	Coiltronics	DR74-151
15	1	Q1	100V, 4.5A N-channel MOSFET	SO-8	Fairchild Semi	FDS3692
16	1	Q2	-60V, 600mA PNP transistor	SOT-23	Zetex Inc.	FMMT2907ATA
17	1	R1, R3	0.47 Ω , 1/2W, 5% chip resistor	SMD2010	Panasonic	ERJ-12ZQJR47U
18	1	R2	8.2 Ω , 1/2W, 5% chip resistor	SMD2010	Panasonic	ERJ-12ZYJ8R2U
19	1	R4	4.42k Ω , 1/8W, 1% chip resistor	SMD0805	Yageo	9C08052A4421FKHFT
20	1	R5	10 Ω , 1/8W, 1% chip resistor	SMD0805	Yageo	9C08052A10R0FKHFT
21	2	R7, R11	10k Ω , 1/8W, 1% chip resistor	SMD0805	Yageo	9C08052A1002FKHFT
22	1	R8	1.69 Ω , 1/4W, 1% chip resistor	SMD1206	Yageo	9C12063A1R69FGHFT
23	1	R9	100 Ω , 1/8W, 1% chip resistor	SMD0805	Yageo	9C08052A1000FKHFT
24	1	R10	5.49k Ω , 1/8W, 1% chip resistor	SMD0805	Yageo	9C08052A5491FKHFT
25	1	U1	Boost-Buck LED Driver	SO-8	Supertex	HV9930LG-G

Supertex inc. does not recommend the use of its products in life support applications, and will not knowingly sell them for use in such applications unless it receives an adequate "product liability indemnification insurance agreement." **Supertex inc.** does not assume responsibility for use of devices described, and limits its liability to the replacement of the devices determined defective due to workmanship. No responsibility is assumed for possible omissions and inaccuracies. Circuitry and specifications are subject to change without notice. For the latest product specifications refer to the **Supertex inc.** (website: <http://www.supertex.com>)