



MIC3203/MIC3203-1 Evaluation Board

High Brightness LED Driver Controller with High-Side Current Sense

General Description

The MIC3203/MIC3203-1 is a hysteretic step-down, constant-current, High-Brightness LED (HB LED) driver. It provides an ideal solution for interior/exterior lighting, architectural and ambient lighting, LED bulbs, and other general illumination applications.

This board enables the evaluation of the MIC3203/MIC3203-1 for 1A LED current. The board is optimized for ease of testing, with all the components on a single side. The device operates from a 4.5V to 42V input voltage range, and controls an external power MOSFET to drive high current LEDs. When the input voltage approaches and crosses UVLO threshold, the internal 5V VCC is regulated and the external MOSFET is turned on if EN pin and DIM pin are high. The inductor current builds up linearly. When the CS pin voltage hits the $V_{CS(MAX)}$ with respect to V_{IN} , the external MOSFET is turned off and the Schottky diode takes over and returns the current to V_{IN} . Then the current through inductor and LEDs starts decreasing. When CS pin hits $V_{CS(MIN)}$, the external MOSFET is turned on and the cycle repeats.

Since the control scheme does not need loop compensation, it makes for a very simple design and avoids problems of instability.

Requirements

This board needs a single bench power source adjustable over the input voltage of $4.5V < V_{IN} < 42V$ that can provide at least 1A of current. The loads can either be active (electronic load) or passive (LEDs) with the ability to dissipate the maximum load power while keeping accessible surfaces ideally $< 70^{\circ}C$.

Precautions

There is no reverse input protection on this board. When connecting the input sources, ensure that the correct polarity is observed.

Under extreme load conditions input transients can be quite large if long test leads are used. In such cases a 100 μ F, 63V electrolytic capacitor is needed at the V_{IN} terminals to prevent over voltage damage to the IC.

Getting Started

1. **Connect V_{IN} supply to the input terminals V_{IN} and GND.** With the output of this supply disabled, set its voltage to the desired input test voltage ($4.5V < V_{IN} < 42V$). This supply voltage should be monitored at the test boards input terminals to allow voltage drops in the test cables (and ammeter if used) to be accounted for. An ammeter can be added inline with the $+V_{IN}$ input terminal to accurately measure input current.

Connect the LEDs to the output terminals between LED+ and LED-. This LED voltage drop depends on manufacturer tolerance and number of LEDs. The LED current can be measured using an ammeter or current probe. A 4.7 μ F ceramic capacitor helps to reduce the current ripple through the LED. The LED current is set to 1A by current sense resistor R_{CS} i.e., 200m Ω .

Selecting the sense resistor refers to the table given in data sheet application sub-section.

2. **Enable the input supply.** By default, the controller is enabled when the input voltage approaches UVLO threshold and crosses 5V, the internal 5V VCC is regulated and the external MOSFET is turned on if EN pin and DIM pin are high. To use the EN and DIM functions of the MIC3203/MIC3203-1, a test point is provided for each of them.

Ordering Information

Part Number	Description
MIC3203YM EV	Evaluation board with MIC3203YM device
MIC3203-1YM EV	Evaluation board with MIC3203-1YM device

Other Features

EN Input

The EN pin provides a logic level control of the output and the voltage has to be 2.0V or higher to enable the current regulator. The output stage is gated by the DIM pin. When the EN pin is pulled low, the regulator goes to off state and the supply current of the device is reduced to below 1µA. In the off state, the output drive is placed in a "tri-state" condition, where MOSFET is in an "off" or non-conducting state. Do not drive the EN pin above the supply voltage.

DIM Input

The DIM pin provides a logic level control for brightness of the LED. A PWM input can be used to control the brightness of LED. DIM high enables the output and its voltage has to be 2.0V or higher. DIM low disables the output, regardless of EN high state.

Current Sense Input

The CS pin provides the high-side current sense to set the LED current with an external sense resistor.

A sense resistor R_{CS} is placed between V_{IN} and LED+ terminal.

The current flowing through LED is sensed and current feedback is provided to the hysteretic step-down regulator.

R_{CS} is given by

$$R_{CS} = \frac{1}{2} \times \left(\frac{V_{CS(MAX)} + V_{CS(MIN)}}{I_{LED}} \right) \quad \text{Error! Bookmark not defined.}$$

defined.

I_{LED} is LED current required to set.

For $V_{CS(MAX)}$ and $V_{CS(MIN)}$, refers to electrical characteristics table in the data sheet.

To calculate the frequency spread across input supply:

$$F_{SW} = \frac{(V_D + I_{LED} \times R_{CS} + V_{LED}) \times (V_{IN} - I_{LED} \times R_{CS} - V_{LED})}{L \times \Delta I_L \times (V_D + V_{IN})}$$

$$\Delta I_L = \frac{V_{CS(MAX)} - V_{CS(MIN)}}{R_{CS}}$$

where : V_D is Schottky diode forward drop

V_{LED} is total LEDs voltage drop

V_{IN} is input voltage

I_{LED} is average LED current

According to the above equation, choose the inductor to make the operating frequency no higher than 1.5MHz.

Refer to the datasheet "Application Information" for more information on components selection guidelines.

Frequency Dithering

The MIC3203 is designed to modulate the $V_{CS(MAX)}$ with amplitude $\pm 6mV$ by a pseudo random generator to generate the $\pm 12\%$ of the switching frequency dithering to spread the frequency spectrum over a wider range and reduce the EMI noise peaks

The MIC3203-1 is non-dithering version of the MIC3203.

Evaluation Board Performance

Efficiency vs. Input Voltage

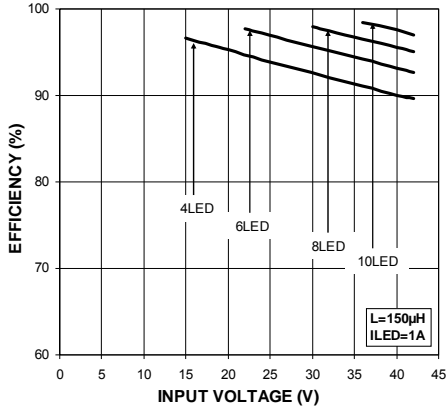

Efficiency vs. Input Voltage

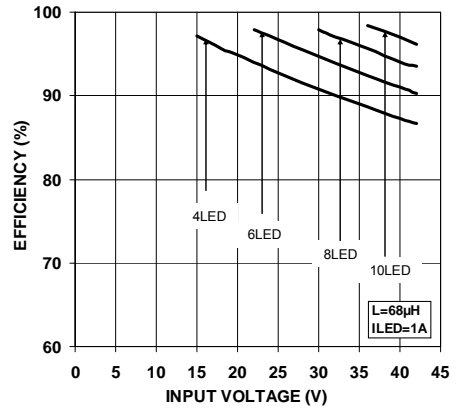

Normalized LED Currents vs. Input Voltage

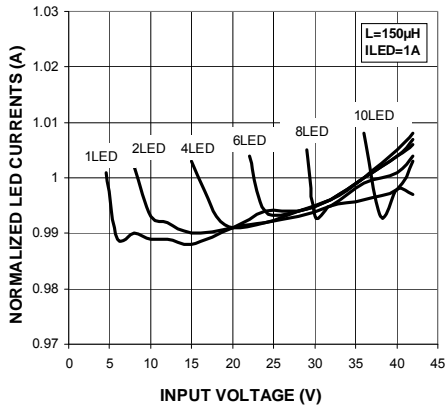

Normalized LED Currents vs. Input Voltage

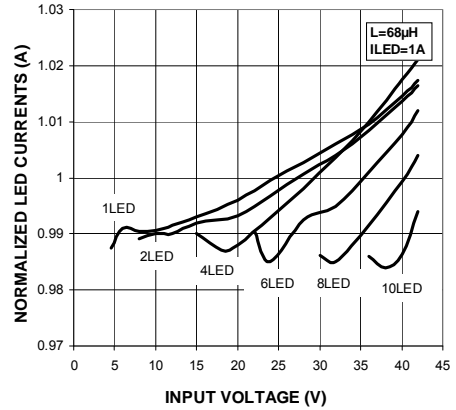

Steady-State Operation @ VIN = 12V

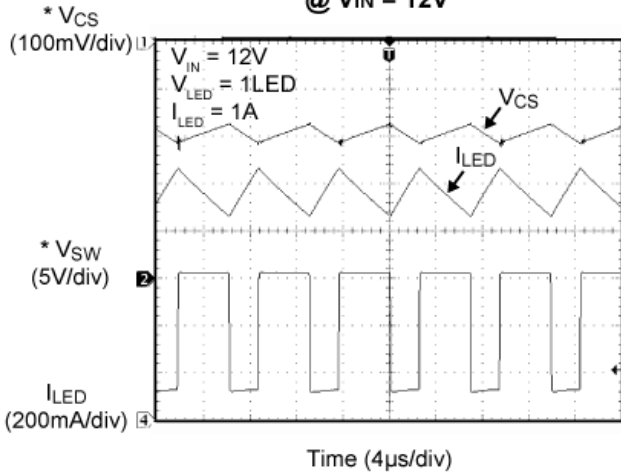

PWM Dimming @ 100Hz (90% Duty Cycle)

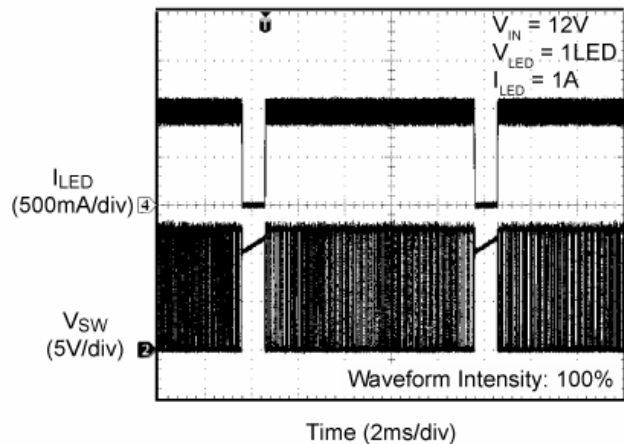

* With regards to V_{IN}

Evaluation Board Schematic

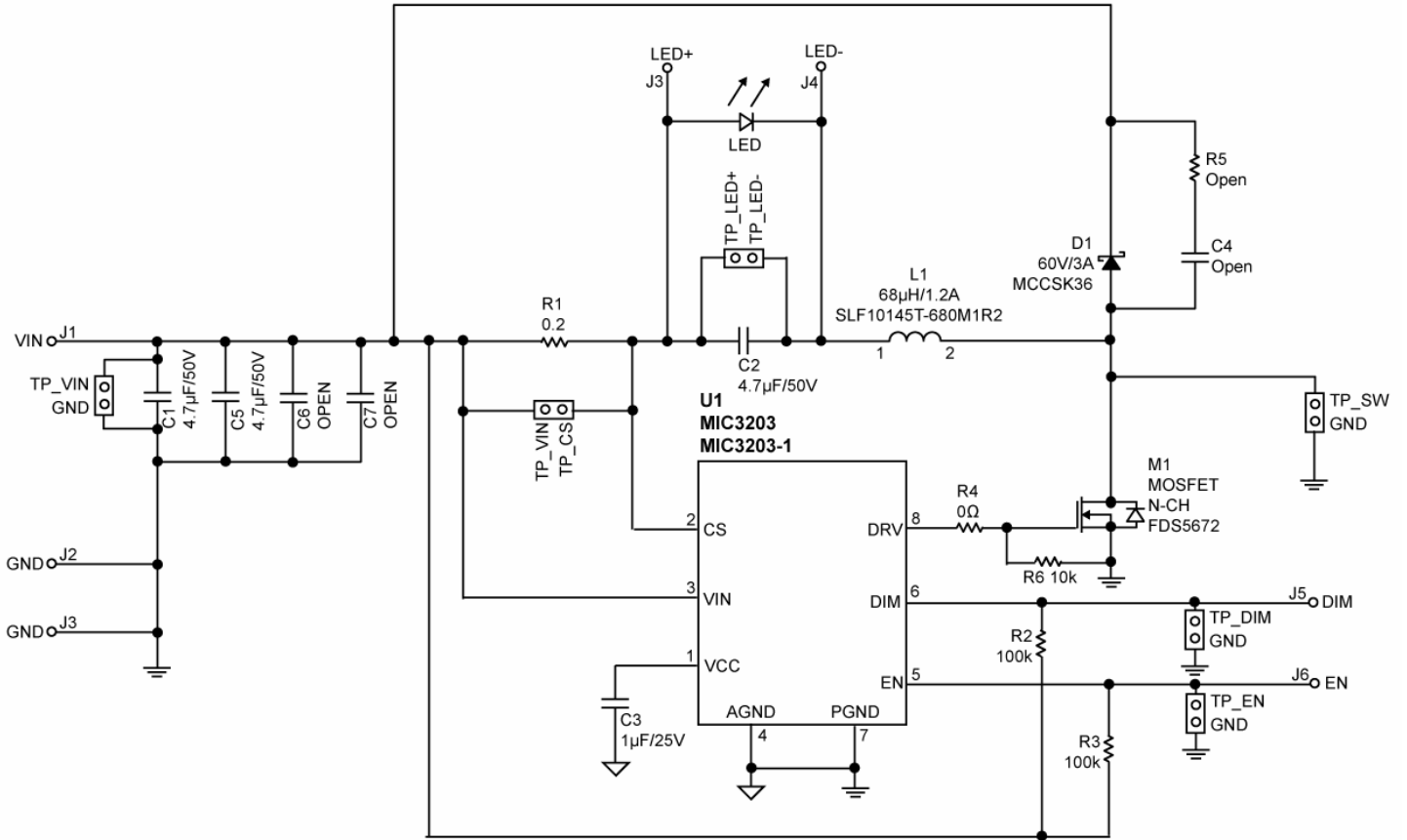

Notes:

1. If bulk capacitor on input rail is away (4 inches or more) from the MIC3203/MIC3203-1, install the 100µF bulk capacitor near VIN.
2. Source impedance should be as low as 10mΩ.

Bill of Materials

Item	Part Number	Manufacturer	Description	Qty.
C1, C2, C5	12105C475KAZ2A	AVX ⁽¹⁾	4.7µF/50V, Ceramic Capacitor, X7R, Size 1210	3
	GRM32ER71H475KA88L	Murata ⁽²⁾		
	C3225X7S1H475M	TDK ⁽³⁾		
C3	08053D105KAT2A	AVX ⁽¹⁾	1µF/25V, Ceramic Capacitor, X5R, Size 0805	1
	GRM21BR71E105KA99L	Murata ⁽²⁾	1µF/25V, Ceramic Capacitor, X7R, Size 0805	
	C2012X7R1E105K	TDK ⁽³⁾	1µF/25V, Ceramic Capacitor, X7R, Size 0805	
C4	(Open) 08055A271JAT2A	AVX ⁽¹⁾	270pF/50V, Ceramic Capacitor NPO, Size 0805	1
	(Open) GRM2165C2A271JA01D	Murata ⁽²⁾	270pF/100V, Ceramic Capacitor NPO, Size 0805	
D1	SK36-TP	MCC ⁽⁴⁾	60V, 3A, SMC, Schottky Diode	1
	SK36	Fairchild ⁽⁵⁾		
	SK36-7-F	Diode ⁽¹⁰⁾		
L1	SLF10145T-680M1R2	SUMIDA ⁽⁶⁾	68µH, 1.2A, SMT, Power Inductor	1
M1	FDS5672	Fairchild ⁽¹¹⁾	MOSFET, N-CH, 60V, SO-8	1
R1	CSR 1/2 0.2 1% I	Stackpole Electronics Inc ⁽⁷⁾	0.2Ω Resistor, 1/2W, 1%, Size 1206	1
R2, R3	CRCW08051003FKEA	Vishay ⁽⁸⁾	100kΩ Resistor, 1%, Size 0805	2
R4	CRCW08050000FKEA	Vishay ⁽⁸⁾	0 Ω Resistor, 1%, Size 0805	1
R5	(Open) CRCW08052R20FKEA	Vishay ⁽⁸⁾	2.2 Ω Resistor, 1%, Size 0805	1
R6	CRCW08051002FKEA	Vishay ⁽⁸⁾	10kΩ Resistor, 1%, Size 0805	1
U1	MIC3203YM	Micrel, Inc. ⁽⁹⁾	High Brightness LED Driver Controller with High-Side Current Sense-Frequency Dithering	1
	MIC3203-1YM		High Brightness LED Driver Controller with High-Side Current Sense-Frequency Non-Dithering	

Notes:

1. AVX: www.avx.com
2. Murata: www.murata.com
3. TDK: www.tdk.com
4. MCC: www.mccsemi.com
5. Fairchild: www.fairchildsemi.com
6. Sumida Tel: www.sumida.com
7. Stackpole Electronics: www.seielect.com
8. Vishay: www.vishay.com
9. Micrel, Inc.: www.micrel.com

PCB Layout Recommendations

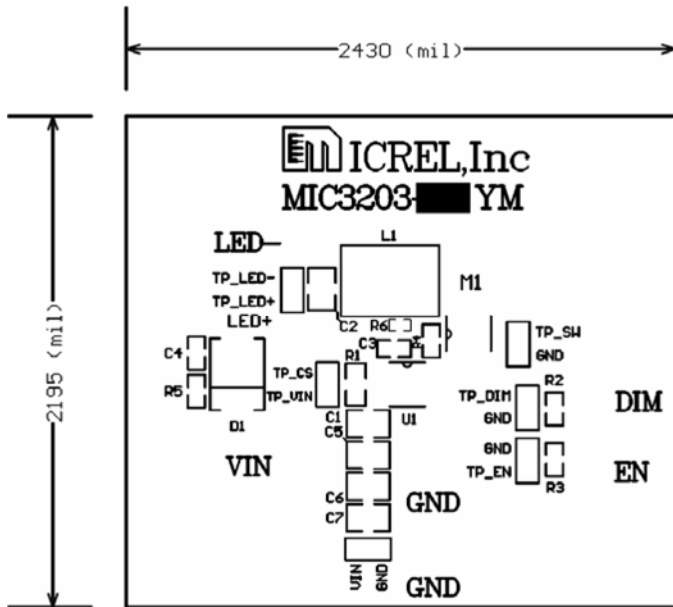

Top Assembly

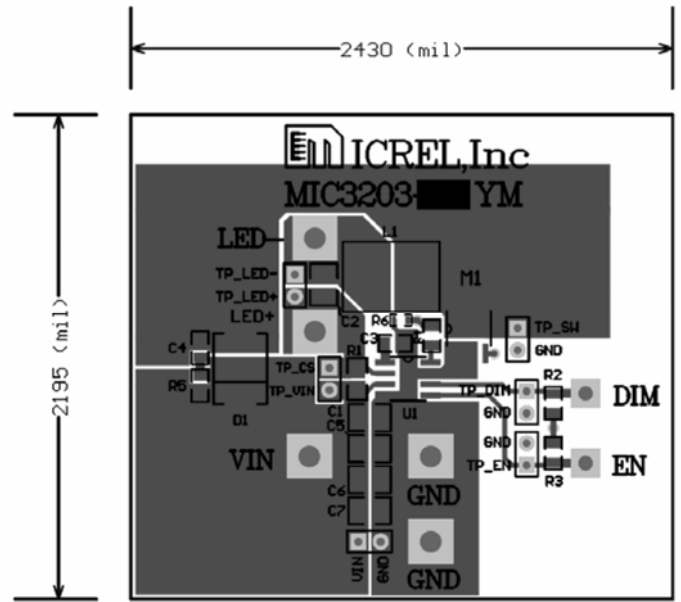

Top Layer

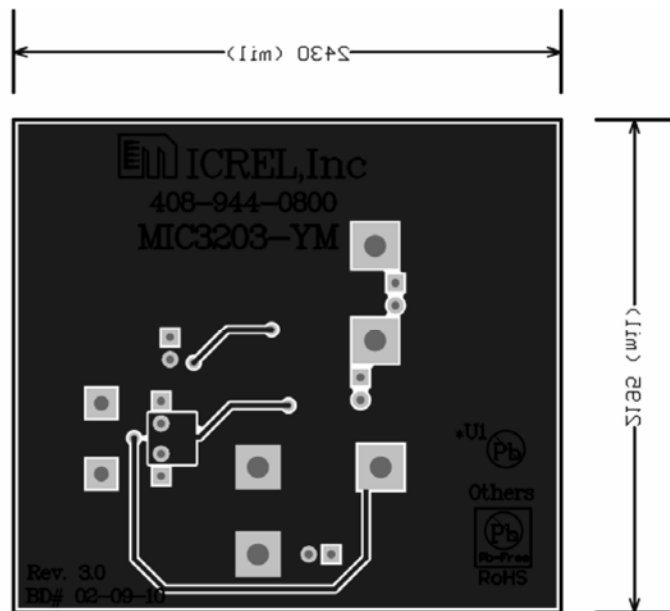

Bottom Layer

MICREL, INC. 2180 FORTUNE DRIVE SAN JOSE, CA 95131 USA
TEL +1 (408) 944-0800 FAX +1 (408) 474-1000 WEB <http://www.micrel.com>

Micrel makes no representations or warranties with respect to the accuracy or completeness of the information furnished in this data sheet. This information is not intended as a warranty and Micrel does not assume responsibility for its use. Micrel reserves the right to change circuitry, specifications and descriptions at any time without notice. No license, whether express, implied, arising by estoppel or otherwise, to any intellectual property rights is granted by this document. Except as provided in Micrel's terms and conditions of sale for such products, Micrel assumes no liability whatsoever, and Micrel disclaims any express or implied warranty relating to the sale and/or use of Micrel products including liability or warranties relating to fitness for a particular purpose, merchantability, or infringement of any patent, copyright or other intellectual property right.

Micrel Products are not designed or authorized for use as components in life support appliances, devices or systems where malfunction of a product can reasonably be expected to result in personal injury. Life support devices or systems are devices or systems that (a) are intended for surgical implant into the body or (b) support or sustain life, and whose failure to perform can be reasonably expected to result in a significant injury to the user. A Purchaser's use or sale of Micrel Products for use in life support appliances, devices or systems is a Purchaser's own risk and Purchaser agrees to fully indemnify Micrel for any damages resulting from such use or sale.

© 2010 Micrel, Incorporated.