

AM/FM Car Antenna Low-Noise Amplifier

General Description

The MAX2180 is a highly integrated AM/FM variable-gain low-noise amplifier ideal for use in automotive active antenna applications. The device features separate AM and FM signal paths, each providing 30dB of gain range, controlled by individual on-chip power detectors. The AM signal path covers a 148kHz to 30MHz input frequency range, while the FM signal path covers 65MHz to 162.5MHz.

The device integrates a voltage regulator and pass transistor, allowing operation using battery voltages in the +8V to +24V range. On-chip thermal protection automatically limits junction temperatures during extreme thermal conditions.

The device is available in a small, 4mm x 4mm, TQFN package and operates over the extended industrial temperature range (-40°C to +85°C).

Applications

Automotive Active Antenna

Features

- ◆ +8V to +24V Supply Voltage Range
- ◆ Integrated AGC Function Eliminates External Pin Diodes
- ◆ High Dynamic Range
- ◆ Low-Noise Design
- ◆ Low External BOM
- ◆ Integrated Thermal Protection
- ◆ Small Package (4mm x 4mm TQFN)

Ordering Information

PART	TEMP RANGE	PIN-PACKAGE
MAX2180ETG+	-40°C to +85°C	24 TQFN-EP*

+Denotes a lead(Pb)-free/ROHS-compliant package.

*EP = Exposed pad.

Simplified Block Diagram

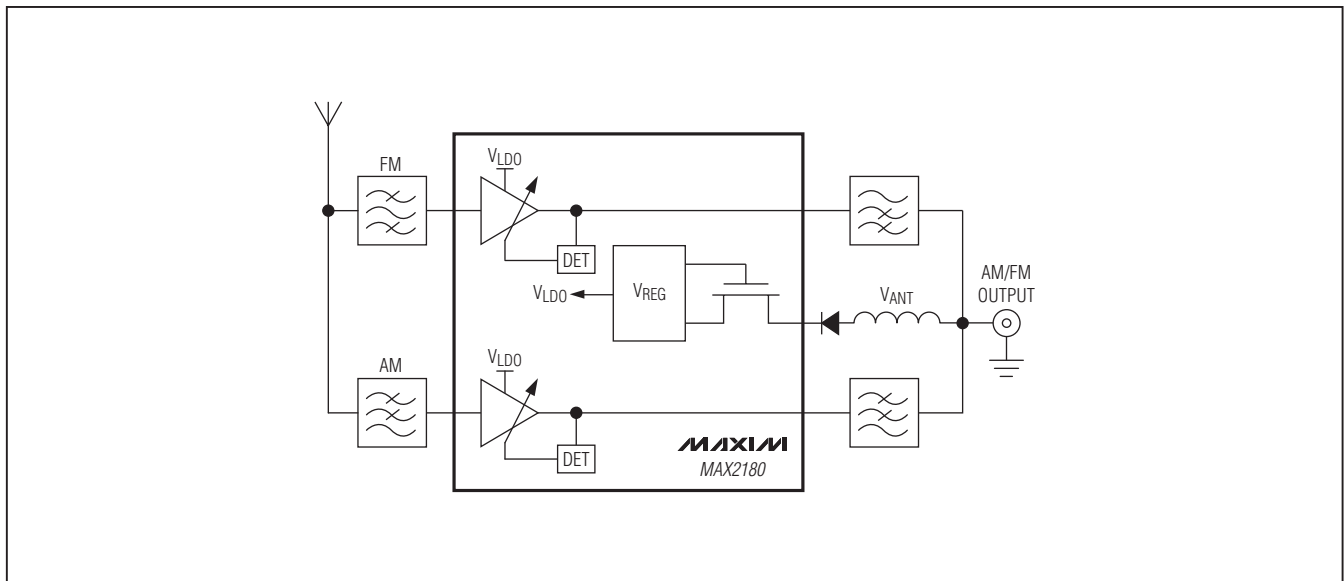

AM/FM Car Antenna Low-Noise Amplifier

ABSOLUTE MAXIMUM RATINGS

VBATT.....	-0.5V to +26V	θ_{JC} (Junction to Case) (Note 1).....	2°C/W
LDO.....	-0.5V to +6V	θ_{JA} (Junction to Ambient) (Note 1).....	36°C/W
FMOUT, AMOUT.....	-0.5V to VLDO	Operating Temperature Range.....	-40°C to +85°C
Short-Circuit Protection FMOUT, AMOUT.....	Indefinite	Junction Temperature.....	+150°C
FMIN, AMIN.....	12Vpp	Storage Temperature Range.....	-65°C to +165°C
Continuous Power Dissipation ($T_A = +70^\circ\text{C}$)		Lead Temperature (TQFN only, soldering, 10s).....	+300°C
(derate 27.8mW/°C above +70°C).....	2220mW	Soldering Temperature (reflow).....	+260°C

Note 1: Package thermal resistances were obtained using the method described in JEDEC specification JESD51-7, using a four-layer board. For detailed information on package thermal considerations, refer to www.maxim-ic.com/thermal-tutorial.



CAUTION! ESD SENSITIVE DEVICE

Stresses beyond those listed under "Absolute Maximum Ratings" may cause permanent damage to the device. These are stress ratings only, and functional operation of the device at these or any other conditions beyond those indicated in the operational sections of the specifications is not implied. Exposure to absolute maximum rating conditions for extended periods may affect device reliability.

DC ELECTRICAL CHARACTERISTICS

(MAX2180 Evaluation Kit as shown, $V_{BATT} = 8\text{V}$ to 15V , $T_A = -40^\circ\text{C}$ to $+85^\circ\text{C}$, unless otherwise noted. Typical values are at $V_{BATT} = 10\text{V}$, $T_A = +25^\circ\text{C}$.) (Note 2)

PARAMETER	CONDITIONS	MIN	TYP	MAX	UNITS
SUPPLY VOLTAGE (V_{BATT})					
VBATT	Operational range	8	10	15	V
	Functional range (Note 3)	15		24	
Voltage Regulation	VLDO (pin 15)		5.25		V
Supply Current	Normal operation ($V_{ANTSENSE} = 0\text{V}$ or $6\text{V} < V_{ANTSENSE} < 12\text{V}$)		78	95	mA
	Antenna fault, ANTSENSE open	10		30	
GAIN CONTROL AND AGC CONTROL (AM_GAIN, AM_DET, FM_DET, FM_GAIN, ANT_SENSE)					
ANTSENSE	Ground	-50			μA
	Open		2.5		V
	LDO			50	μA
FMDET	Ground	-50			μA
	LDO			50	
Digital Control	Ground	-50			μA
	Open		2.5		V
	LDO			50	μA

AC ELECTRICAL CHARACTERISTICS

(MAX2180 Evaluation Kit, $T_A = -40^\circ\text{C}$ to $+85^\circ\text{C}$, $V_{BATT} = 8\text{V}$ to 15V , unless otherwise noted. Typical values are at $V_{BATT} = 10\text{V}$, $T_A = +25^\circ\text{C}$, load impedance = 50Ω , AM channel bandwidth = 9kHz , RAM = 10Ω (AM gain = 6dB), FM low-gain configuration, FM gain = 6dB .) (Note 2)

PARAMETER	CONDITIONS	MIN	TYP	MAX	UNITS
AM AMPLIFIER					
Frequency Range		0.148		30	MHz
Voltage Gain Maximum	RAM = short, $f_{IN} = 1\text{MHz}$	5	6.5	8	dB
Voltage Gain Minimum	RAM = 330Ω , $f_{IN} = 1\text{MHz}$	-2.8	-1.3	+0.2	dB
Input Capacitance	$f_{IN} = 1\text{MHz}$		12.5		pF
Output Impedance	$f_{IN} = 1\text{MHz}$			17	Ω

AM/FM Car Antenna Low-Noise Amplifier

MAX2180

AC ELECTRICAL CHARACTERISTICS (continued)

(MAX2180 Evaluation Kit, $T_A = -40^{\circ}\text{C}$ to $+85^{\circ}\text{C}$, $V_{BATT} = 8\text{V}$ to 15V , unless otherwise noted. Typical values are at $V_{BATT} = 10\text{V}$, $T_A = +25^{\circ}\text{C}$, load impedance = 50Ω , AM channel bandwidth = 9kHz , $R_{AM} = 10\Omega$ (AM gain = 6dB), FM low-gain configuration, FM gain = 6dB .) (Note 2)

PARAMETER	CONDITIONS	MIN	TYP	MAX	UNITS
Gain Response (Relative to 1MHz)	0.148MHz to 0.285MHz (Note 4)	-1		+1	dB
	0.520MHz to 1.710MHz (Note 4)	-1		+1	
	5.9MHz to 20MHz (Note 4)	-2.7		+1	
	20MHz to 30MHz	-4		+1	
Gain Control Range	At 1MHz	35	40		dB
Output Noise	0.148MHz to 0.285MHz		-5		dB μV
	0.520MHz to 1.710MHz		-8		
	5.90MHz to 30MHz		-8		
IMD2	$V_{IN} = +120\text{dB}\mu\text{V}/\text{tone}$, $+86\text{dB}\mu\text{V}$ AGC threshold, 0.4MHz and 0.5MHz tones		-70		dB
IMD3	$V_{IN} = +120\text{dB}\mu\text{V}/\text{tone}$, $+86\text{dB}\mu\text{V}$ AGC threshold, 0.4MHz and 0.5MHz tones		-66		dB
AGC Threshold	Output level, $f_{IN} = 1\text{MHz}$, AMDET connected to ground		79		dB μV
	Output level, $f_{IN} = 1\text{MHz}$, AMDET open		83		
	Output level, $f_{IN} = 1\text{MHz}$, AMDET connected to LDO		86		
AGC Threshold Variation	Relative to 1MHz tone ($148\text{kHz} < f_{IN} < 1710\text{kHz}$)		2.2		dB
FM AMPLIFIER					
Frequency Range		76		162.5	MHz
Power Gain Maximum	$f_{IN} = 97\text{MHz}$, FMGAIN connected to LDO	6.5	8.5	10	dB
	$f_{IN} = 97\text{MHz}$, FMGAIN connected to LDO, FM high-gain configuration (Note 5)		10.5		
Power Gain Minimum	$f_{IN} = 97\text{MHz}$, FMGAIN = short	4.0	5.8	7.6	dB
Gain Flatness	76MHz to 90MHz (Note 4)			0.5	dB
	87MHz to 108MHz (Note 4)			0.5	
	162.5MHz relative to 97MHz			2.5	
Noise Figure	$f_{IN} = 97\text{MHz}$, $T_A = +25^{\circ}\text{C}$ (Note 5)		3.7		dB
Input Return Loss	50Ω source		12		dB
Output Return Loss	50Ω load		12		dB
Gain Control Range	$f_{IN} = 97\text{MHz}$	26	29		dB
IMD2 (FM to AM)	Output tones of 107MHz and 108MHz, $+100\text{dB}\mu\text{V}$ AGC threshold (A - B)		26		dB μV
IMD3	$V_{IN} = +120\text{dB}\mu\text{V}/\text{tone}$, $+100\text{dB}\mu\text{V}$ AGC threshold, 107MHz and 108MHz tones		66		dB
	$V_{IN} = +120\text{dB}\mu\text{V}/\text{tone}$, $+100\text{dB}\mu\text{V}$ AGC threshold, 107MHz and 108MHz tones, FM high-gain configuration (Note 5)		63		
AGC Threshold	Minimum output threshold		90		dB μV
	Maximum output threshold		104		
AGC Threshold Variation	Relative to 97MHz tone (76MHz to 108MHz)		1		dB

Note 2: Min and max values are production tested at $T_A = +25^{\circ}\text{C}$ and $+85^{\circ}\text{C}$. Min and Max limits at $T_A = -40^{\circ}\text{C}$ are guaranteed by design and characterization.

Note 3: Device automatically reduces current to limit die temperature within a safe range, but otherwise remains functional.

Note 4: Guaranteed by design and characterization.

Note 5: FM high-gain configuration. See the MAX2180 Evaluation Kit schematic.

AM/FM Car Antenna Low-Noise Amplifier

Typical Operating Characteristics

(MAX2180 Evaluation Kit, low-gain configuration, $V_{BATT} = 10V$, $T_A = +25^\circ C$, unless otherwise noted.)

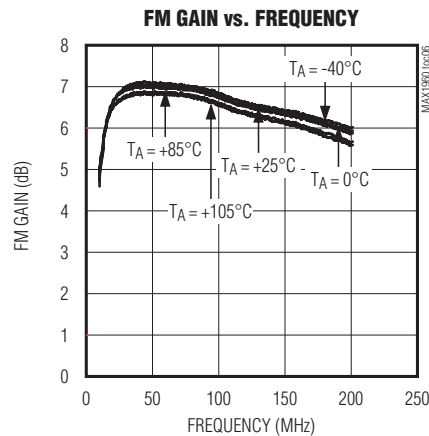
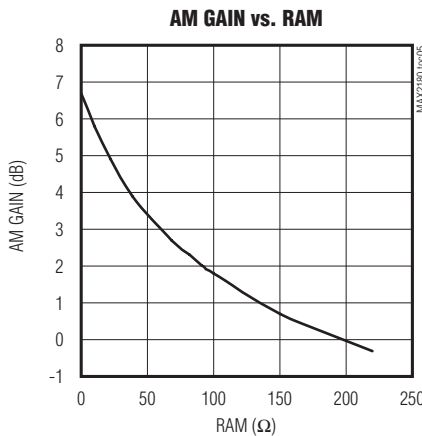
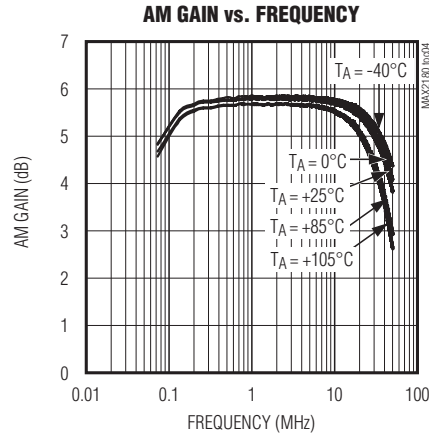
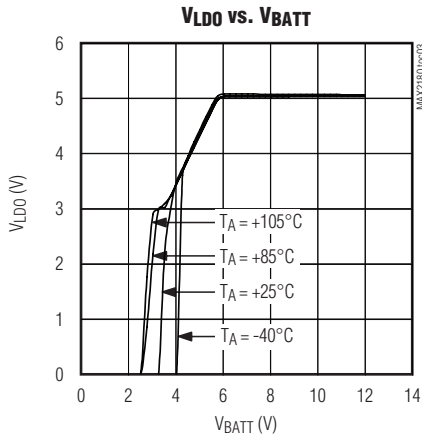
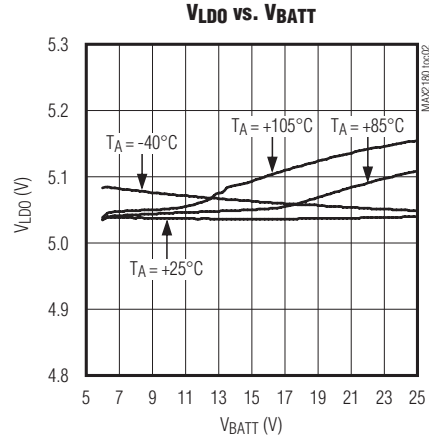
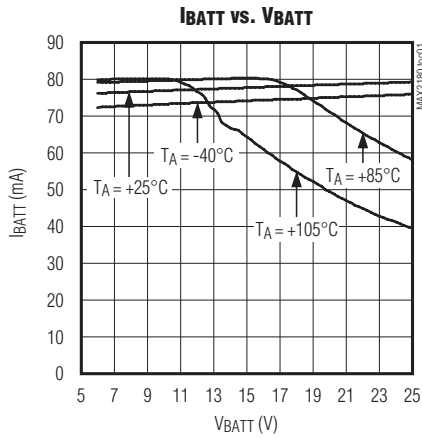

AM/FM Car Antenna Low-Noise Amplifier

MAX2180

Typical Operating Characteristics (continued)

(MAX2180 Evaluation Kit, low-gain configuration, $V_{BATT} = 10V$, $T_A = +25^\circ C$, unless otherwise noted.)

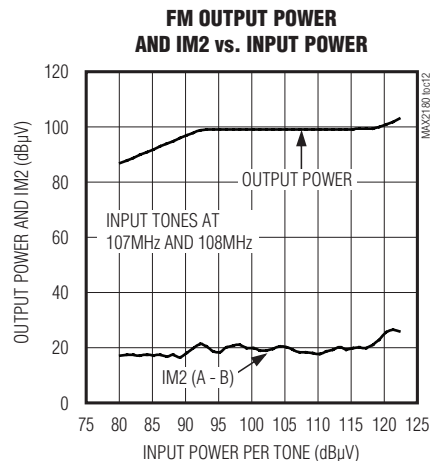
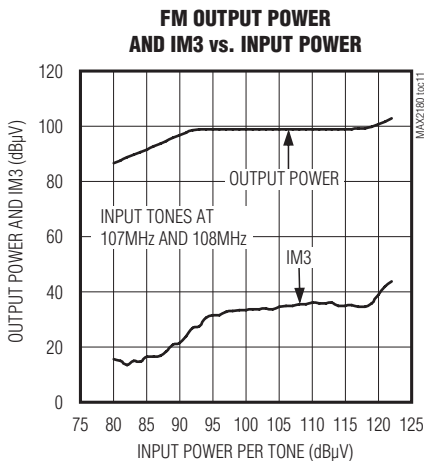
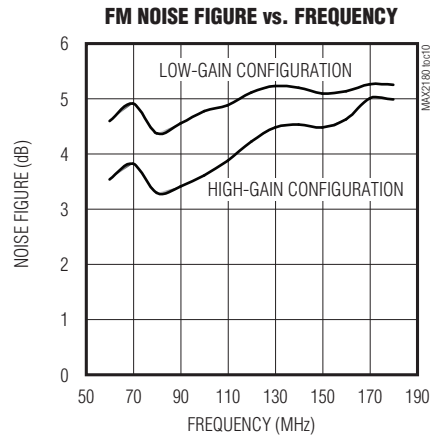
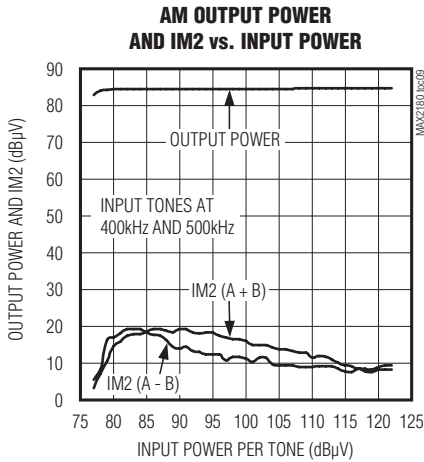
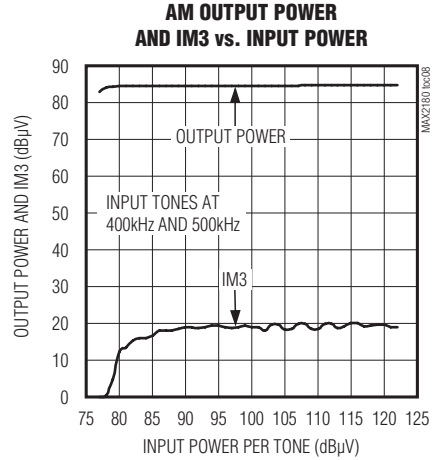
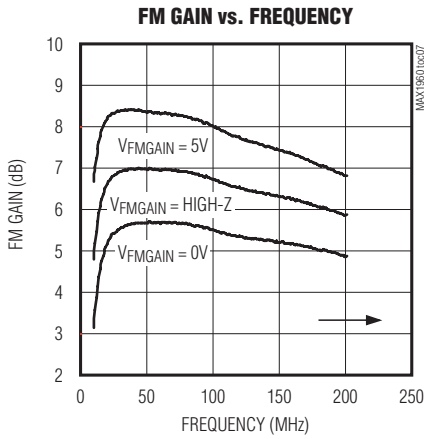

AM/FM Car Antenna Low-Noise Amplifier

Pin Configuration

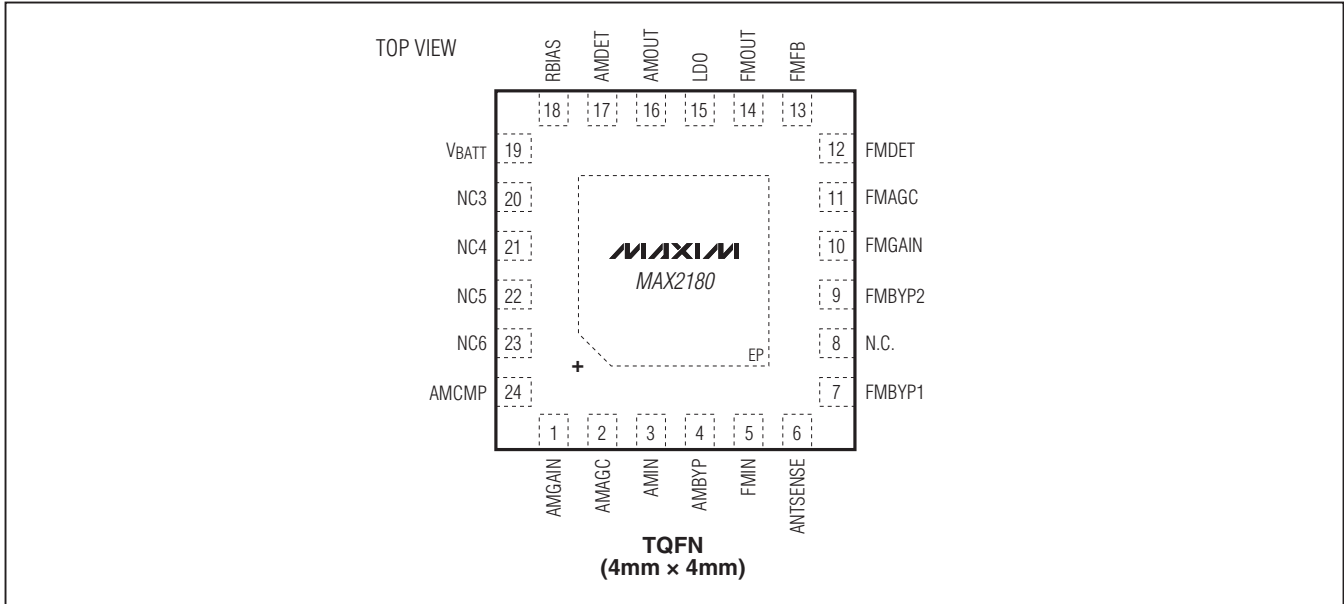

Pin Description

PIN	NAME	DESCRIPTION
1	AMGAIN	AM Gain Adjust. Per Table 1, place resistor to ground for desired voltage gain. See the <i>Detailed Description</i> section.
2	AMAGC	AM AGC AC Ground. Connect a 0.1 μ F capacitor to ground.
3	AMIN	AM Input. AC-couple to AM input lowpass filter.
4	AMBYP	AM AC Ground. Connect a 0.1 μ F capacitor to ground.
5	FMIN	FM Input. AC-couple to FM input bandpass filter.
6	ANTSENSE	Connect to Antenna Input Connector Center Conductor Through a 100k Ω Resistor. See the <i>Detailed Description</i> section.
7	FMBYP1	FM AC Ground. Connect a 100pF capacitor to ground.
8	N.C.	No Connection to Die
9	FMBYP2	FM AC Ground. Connect a 100pF capacitor to ground.
10	FMGAIN	FM Gain Adjust. Connect to ground, leave open, or connect to LDO for the desired FM gain. See the <i>Detailed Description</i> section.
11	FMAGC	FM AGC AC Ground. Connect a 0.1 μ F capacitor to ground.
12	FMDET	FM Attack Point Adjust. Connect the desired resistor to ground. See the <i>Detailed Description</i> section.
13	FMFB	FM Feedback. Connect through resistor RFM and a 2200pF capacitor to FMOUT. See the <i>MAX2180 Evaluation Kit</i> schematic.
14	FMOUT	FM Output
15	LDO	DC Regulator Output. Connect a 10 μ F and 1000pF capacitor to ground.
16	AMOUT	AM Output
17	AMDET	AM Attack Point Adjust. Connect to ground, leave open, or connect to LDO for the desired AM attack point. See the <i>Detailed Description</i> section.

AM/FM Car Antenna Low-Noise Amplifier

MAX2180

Pin Description (continued)

PIN	NAME	DESCRIPTION
18	RBIAS	Connect a 1% Tolerance 20k Ω Resistor to Ground
19	VBATT	Battery Supply
20, 21, 22, 23	NC3, NC4, NC5, NC6	No Connection to Die. Use as a thermal path on layer 1 of PCB from exposed pad to thermal sink.
24	AMCMP	AM Compensation. Leave open for RAM < 68 Ω and short for RAM \geq 68 Ω . See the <i>Detailed Description</i> section.
—	EP	Exposed Pad. Ground.

Detailed Description

Setting Signal Path Gain and AGC Attack Point

The MAX2180 allows independent variation of the gain and AGC attack points on the AM and FM signal paths. Gain and attack point are adjusted by changing the conditions on the AMGAIN, AMDET, FMGAIN, and FMDET pins.

AM Signal Path

The gain of the AM signal path is adjusted by changing the resistor RAM, which is connected to AMGAIN through a 0.1 μ F capacitor. Table 1 shows the gain associated with several resistor values. The output attack point of the AM signal path can be set to one of three values depending on the state of the AMDET pin, as shown in Table 2.

Table 1. AM Signal Path Gain

RAM (Ω)	AM GAIN (dB, TYP)
0	6.5
22	5
68	2.5
180	0.5
330	-1

Table 2. AM Signal Path Attack Point

PIN AMDET	AM OUTPUT ATTACK POINT (dB μ V, TYP)
Ground	79
Open	83
VLDO	86

Note: For values of RAM \geq 68 Ω , pin AMCMP must be shorted to ground. For values of RAM < 68 Ω , leave AMCMP open.

FM Signal Path

The FM signal path can be configured for either high-gain or low-gain operation. In the high-gain configuration, typical FM gain is 10.5dB. In the low-gain configuration, typical FM gain can be set using the FMGAIN pin as shown in Table 3. Component values for high-gain and low-gain configurations are shown in Table 5.

The output attack point of the FM signal path is adjusted by changing the resistor RFMDET, connected to the FMDET pin. Table 4 shows the attack point associated with several resistor values.

Table 3. FM Signal Path Gain

PIN FMGAIN	FM GAIN (dB, TYP)
Ground	8.5
Open	7.1
VLDO	5.8

Table 4. FM Signal Path Attack Point

RFMDET (k Ω)	FM OUTPUT ATTACK POINT (dB μ V, TYP)
0	104
10	100
18	96
27	95
39	94
47	93
56	92
68	90

AM/FM Car Antenna Low-Noise Amplifier

Antenna Sensing

In some applications, a bias voltage might be present on the car antenna or the car antenna might be DC shorted to ground in normal operation. In these situations, the device can sense an antenna fault condition and report this by setting the VBATT current.

Connecting the ANTSENSE pin to the car antenna through a 100k Ω resistor enables this function. If a DC bias of 6V to 12V is present on the antenna, the device operates normally. If the antenna is DC shorted to ground, the device also operates normally. However, if the antenna is a DC open circuit, the device VBATT current drops to a value between 10mA to 30mA. This provides a method for the car audio system to detect an antenna fault. If this function is not required, the ANTSENSE pin should be connected to ground.

Layout Recommendations

For best performance, the device must be mounted on a PCB which is designed for a low thermal resistance. A thermal ground must be placed near the device. This

can consist of a mounting screw to a large thermal mass, ideally placed no more than 5mm from the package. The backside ground of the MAX2180 must be connected to a thermal ground plane on the PCB using at least nine plated through holes. Finally, a wide trace on the PCB top metal from the paddle area, connecting pins 20–23, and proceeding to the mounting hole further improves thermal performance.

The MAX2180 is equipped with thermal-protection circuitry that maintains junction temperature at safe levels when the device is operated outside its specified operating range. For ambient temperatures up to +85°C and VBATT up to +15V, the thermal protection does not engage.

Refer to www.maxim-ic.com for the MAX2180 Evaluation Kit schematic, Gerber data, PADS layout file, and BOM information.

Package Information

For the latest package outline information and land patterns, go to www.maxim-ic.com/packages. Note that a "+", "#", or "-" in the package code indicates RoHS status only. Package drawings may show a different suffix character, but the drawing pertains to the package regardless of RoHS status.

Table 5. FM Signal Path Component Values

COMPONENT	HIGH-GAIN CONFIGURATION	LOW-GAIN CONFIGURATION
C1	82pF	1000pF
C2	1000pF	Open
C3	33pF	1000pF
R1	200 Ω	Open
RFM	390 Ω	Short
L1	100nH	Open
L2	150nH	2200nH

PACKAGE TYPE	PACKAGE CODE	OUTLINE NO.	LAND PATTERN NO.
24 TQFN	T2444+3	21-0139	90-0068

AM/FM Car Antenna Low-Noise Amplifier

MAX2180 Evaluation Kit

MAX2180

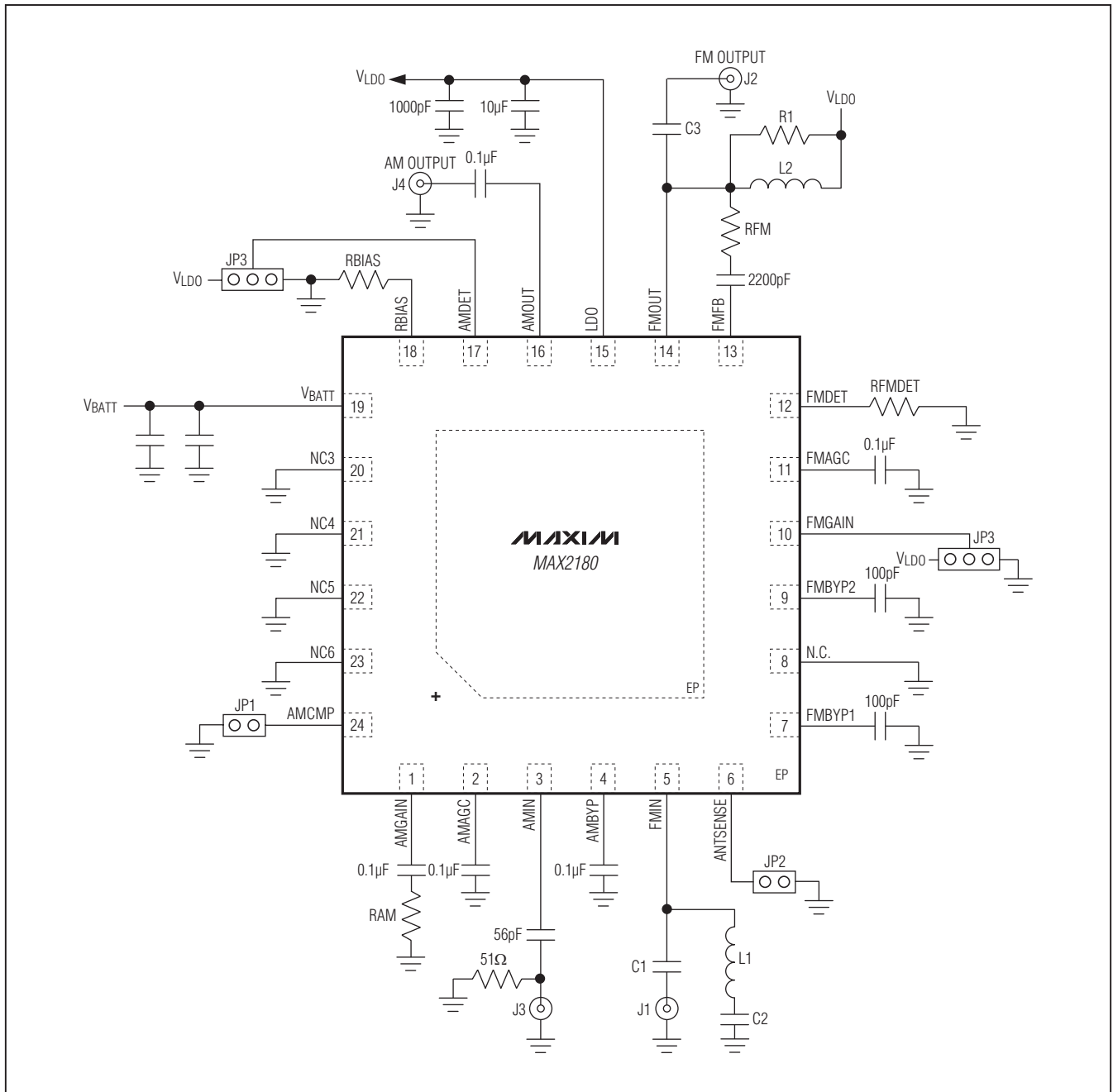

AM/FM Car Antenna Low-Noise Amplifier

Revision History

REVISION NUMBER	REVISION DATE	DESCRIPTION	PAGES CHANGED
0	6/10	Initial release	—

Maxim cannot assume responsibility for use of any circuitry other than circuitry entirely embodied in a Maxim product. No circuit patent licenses are implied. Maxim reserves the right to change the circuitry and specifications without notice at any time.

10 _____ **Maxim Integrated Products, 120 San Gabriel Drive, Sunnyvale, CA 94086 408-737-7600**

© 2010 Maxim Integrated Products

Maxim is a registered trademark of Maxim Integrated Products, Inc.