

Board Name	Device	CAN	USB
MCB1114	LPC1114FBD48/301	-	-
MCB11C14	LPC11C14FBD48/301	X	-
MCB11U2x	LPC11U2xFBD48	-	X
MCB1313	LPC1313FBD48	-	-
MCB1343	LPC1343FBD48	-	X

KEIL SOFTWARE

Project-Version: MCB1000-Vers26

Date / Time: 17.09.2010 09:24:11

Sheet: 1/3

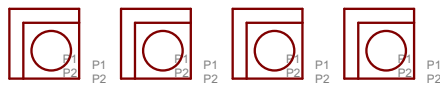
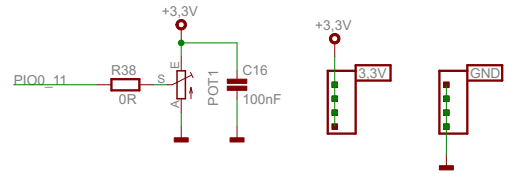
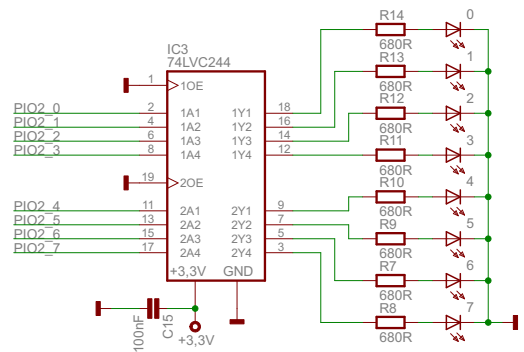
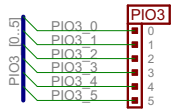
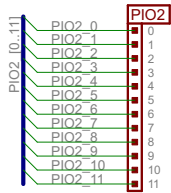
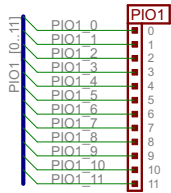
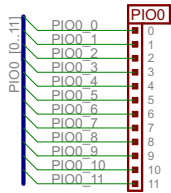

KEIL SOFTWARE

Project-Version: MCB1000-Vers26
 Date / Time: 17.09.2010 09:24:11
 Sheet: 3/3