



P-Channel Enhancement-Mode Vertical DMOS FET

Features

- ▶ Free from secondary breakdown
- ▶ Low power drive requirement
- ▶ Ease of paralleling
- ▶ Low C_{ISS} and fast switching speeds
- ▶ High input impedance and high gain
- ▶ Excellent thermal stability
- ▶ Integral source-to-drain diode

Applications

- ▶ Motor controls
- ▶ Converters
- ▶ Amplifiers
- ▶ Switches
- ▶ Power supply circuits
- ▶ Drivers (relays, hammers, solenoids, lamps, memories, displays, bipolar transistors, etc.)

General Description

The Supertex VP3203 is an enhancement-mode (normally-off) transistor that utilizes a vertical DMOS structure and Supertex's well-proven silicon-gate manufacturing process. This combination produces a device with the power handling capabilities of bipolar transistors, and the high input impedance and positive temperature coefficient inherent in MOS devices. Characteristic of all MOS structures, this device is free from thermal runaway and thermally-induced secondary breakdown.

Supertex's vertical DMOS FETs are ideally suited to a wide range of switching and amplifying applications where very low threshold voltage, high breakdown voltage, high input impedance, low input capacitance, and fast switching speeds are desired.

Ordering Information

Device	Package Options			BV_{DSS}/BV_{DGS} (V)	$R_{DS(ON)}$ (max) (Ω)	$I_{D(ON)}$ (min) (A)
	TO-92	TO-243AA (SOT-89)	Die*			
VP3203	VP3203N3-G	VP3203N8-G	VP3203ND	-30	0.6	14.0

-G indicates package is RoHS compliant ("Green")
* Mil visual screening available.



Absolute Maximum Ratings

Parameter	Value
Drain-to-source voltage	BV_{DSS}
Drain-to-gate voltage	BV_{DGS}
Gate-to-source voltage	$\pm 20V$
Operating and storage temperature	$-55^{\circ}C$ to $+150^{\circ}C$
Soldering temperature*	$300^{\circ}C$

Absolute Maximum Ratings are those values beyond which damage to the device may occur. Functional operation under these conditions is not implied. Continuous operation of the device at the absolute rating level may affect device reliability. All voltages are referenced to device ground.

* Distance of 1.6mm from case for 10 seconds.

Pin Configurations

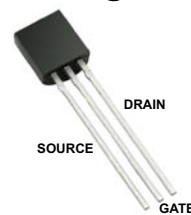

TO-92 (N3)

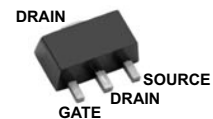

TO-243AA (SOT-89) (N8)

Product Marking

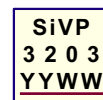

YY = Year Sealed
WW = Week Sealed
_____ = "Green" Packaging

Package may or may not include the following marks: Si or

TO-92 (N3)

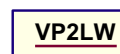

W = Code for week sealed
_____ = "Green" Packaging

Packages may or may not include the following marks: Si or

TO-243AA (SOT-89) (N8)

Thermal Characteristics

Package	I _D (continuous) [†] (mA)	I _D (pulsed) (A)	Power Dissipation @T _A = 25°C (W)	θ _{jc} (°C/W)	θ _{ja} (°C/W)	I _{DR} [†] (mA)	I _{DRM} (A)
TO-92	-650	-4.0	0.74	125	170	-650	-4.0
TO-243AA (SOT-89)	-1100	-4.0	1.6‡	15	78‡	-1100	-4.0

† I_D (continuous) is limited by max rated T_j.
‡ Mounted on FR5 board, 25mm x 25mm x 1.57mm.

Electrical Characteristics (T_A = 25°C unless otherwise specified)

Sym	Parameter	Min	Typ	Max	Units	Conditions	
BV _{DSS}	Drain-to-source breakdown voltage	-30	-	-	V	V _{GS} = 0V, I _D = -10mA	
V _{GS(th)}	Gate threshold voltage	-1.0	-	-3.5	V	V _{GS} = V _{DS} , I _D = -10mA	
ΔV _{GS(th)}	Change in V _{GS(th)} with temperature	-	-	-5.5	mV/°C	V _{GS} = V _{DS} , I _D = -10mA	
I _{GSS}	Gate body leakage	-	-1.0	-100	nA	V _{GS} = ± 20V, V _{DS} = 0V	
I _{DSS}	Zero gate voltage drain current	-	-	-10	μA	V _{GS} = 0V, V _{DS} = Max Rating	
		-	-	-1.0	mA	V _{DS} = 0.8 Max Rating, V _{GS} = 0V, T _A = 125°C	
I _{D(ON)}	On-state drain current	-	-14	-	A	V _{GS} = -10V, V _{DS} = -5.0V	
R _{DS(ON)}	Static drain-to-source on-state resistance	TO-92	-	-	1.0	Ω	V _{GS} = -4.5V, I _D = -1.5A
		SOT-89	-	-	1.0		V _{GS} = -4.5V, I _D = -750mA
		TO-92	-	-	0.6		V _{GS} = -10V, I _D = -3.0A
		SOT-89	-	-	0.6		V _{GS} = -10V, I _D = -1.5A
ΔR _{DS(ON)}	Change in R _{DS(ON)} with temperature	-	-	1.0	%/°C	V _{GS} = -10V, I _D = -1.5A	
G _{FS}	Forward transductance	1000	2000	-	mmho	V _{DS} = -25V, I _D = -2.0A	
C _{ISS}	Input capacitance	-	200	300	pF	V _{GS} = 0V, V _{DS} = -25V, f = 1.0MHz	
C _{OSS}	Common source output capacitance	-	100	120			
C _{RSS}	Reverse transfer capacitance	-	45	60			
t _{d(ON)}	Turn-on delay time	-	-	10	ns	V _{DD} = -25V, I _D = -2.0A, R _{GEN} = 10Ω	
t _r	Rise time	-	-	15			
t _{d(OFF)}	Turn-off delay time	-	-	25			
t _f	Fall time	-	-	25			
V _{SD}	Diode forward voltage drop	-	-	-1.6	V	V _{GS} = 0V, I _{SD} = -1.5A	
t _{rr}	Reverse recovery time	-	300	-	ns	V _{GS} = 0V, I _{SD} = -1.0A	

Notes:

- All D.C. parameters 100% tested at 25°C unless otherwise stated. (Pulse test: 300μs pulse, 2% duty cycle.)
- All A.C. parameters sample tested.

Switching Waveforms and Test Circuit

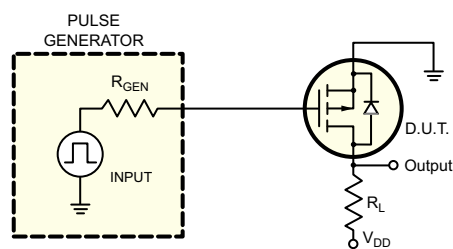
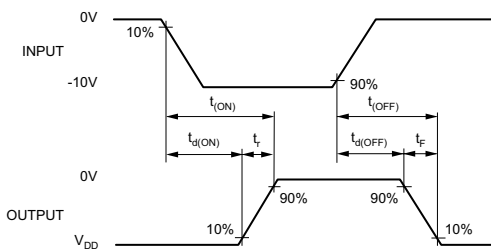

Typical Performance Curves

Output Characteristics

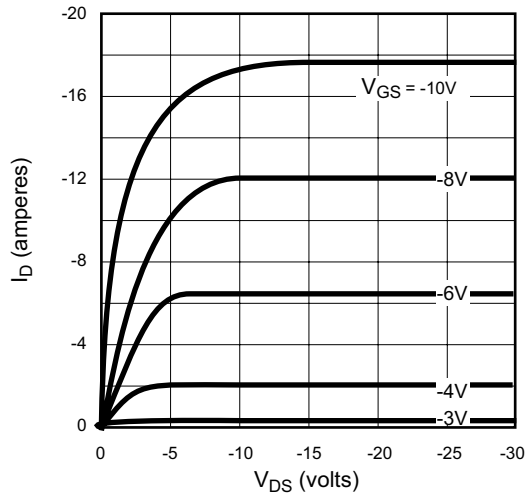

Saturation Characteristics

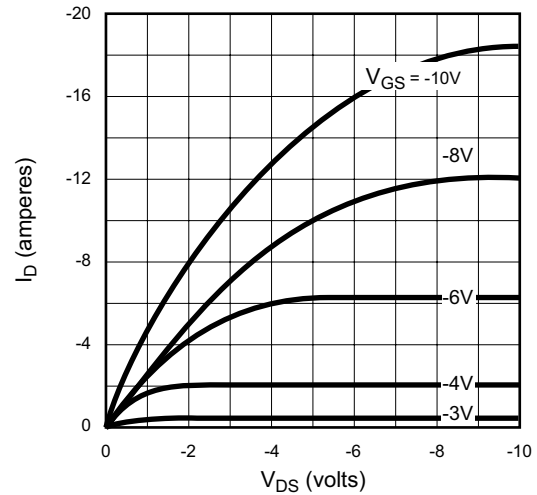

Transconductance vs. Drain Current

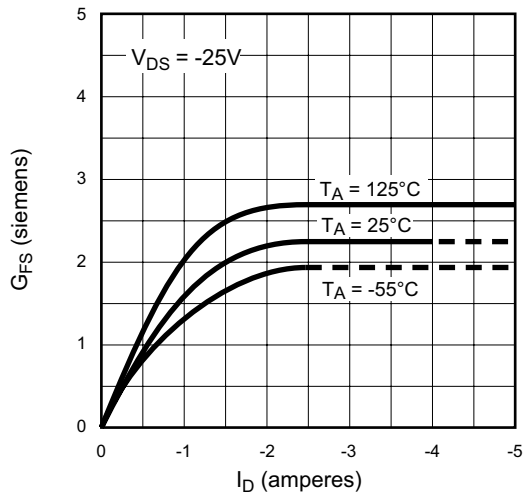

Power Dissipation vs. Ambient Temperature

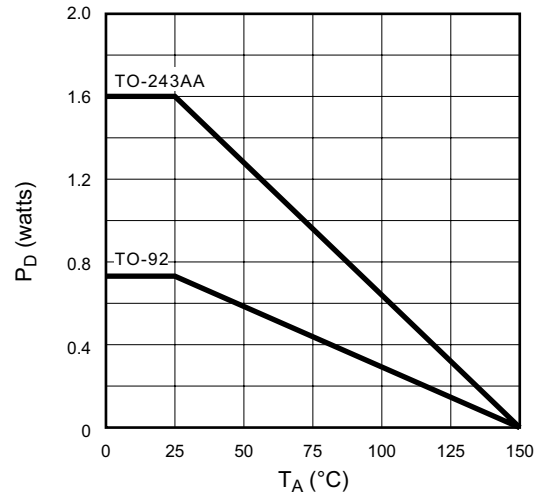

Maximum Rated Safe Operating Area

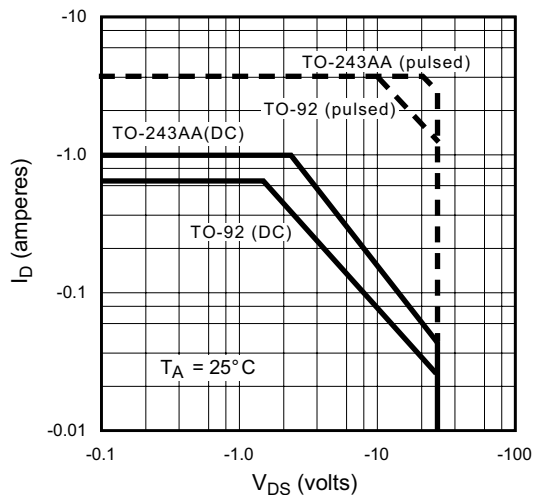

Thermal Response Characteristics

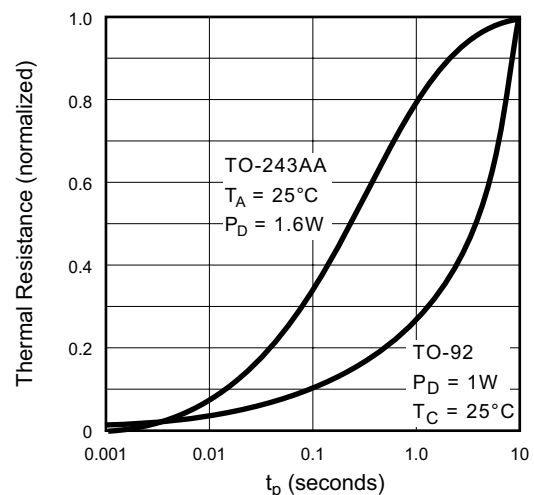

Typical Performance Curves (cont.)

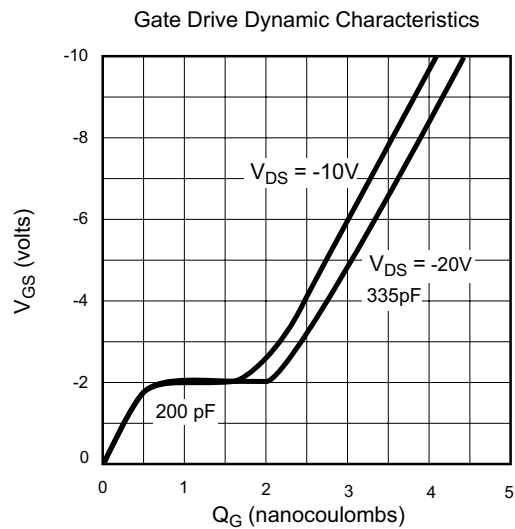
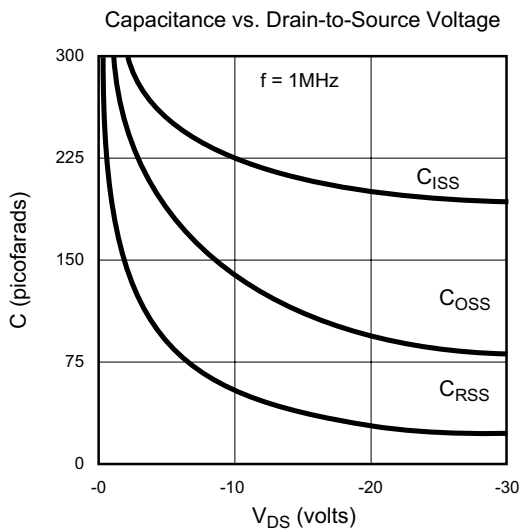
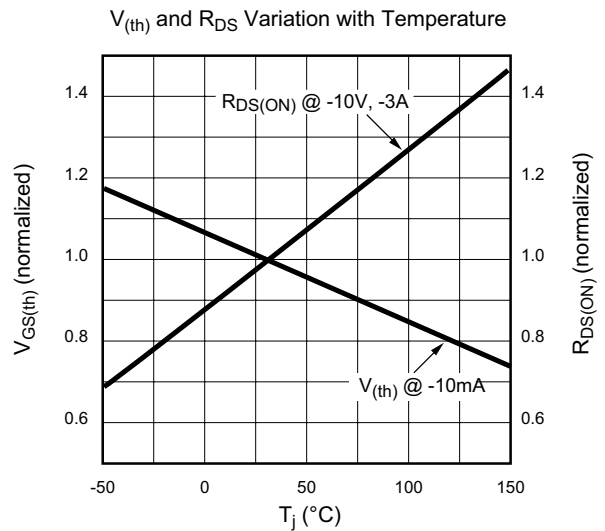
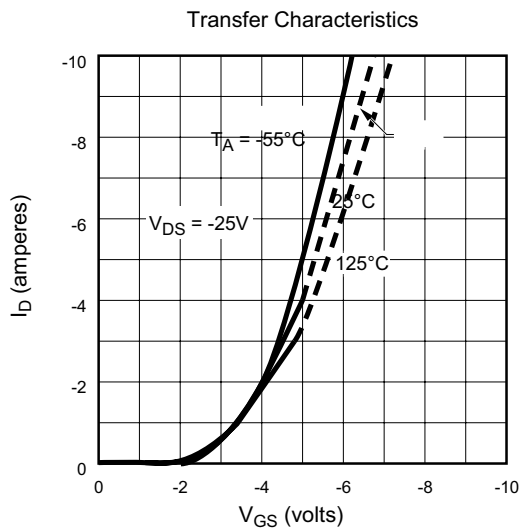
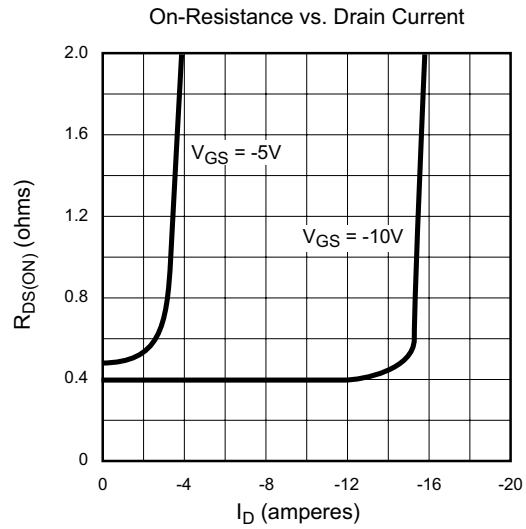
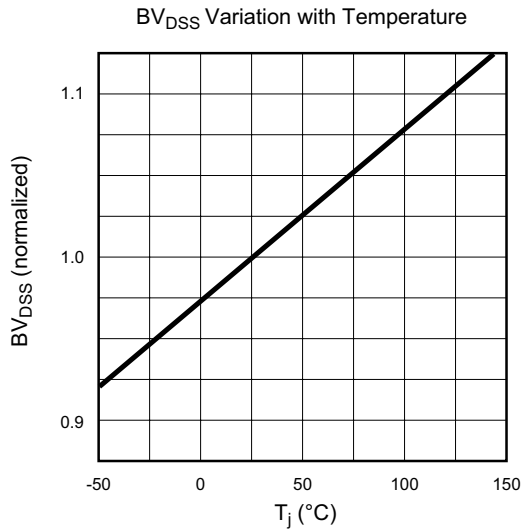

3-Lead TO-92 Package Outline (N3)

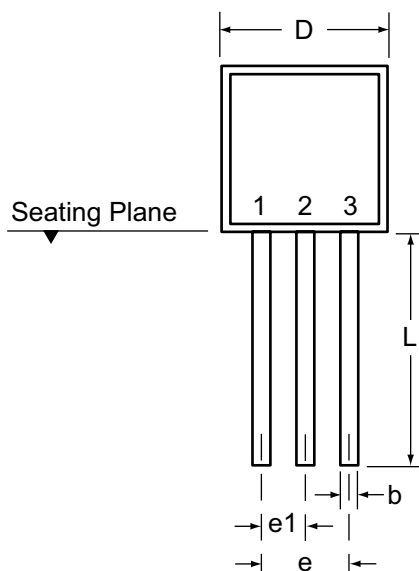

Front View

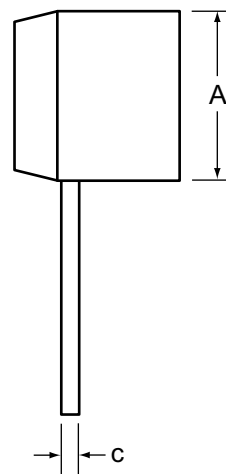

Side View

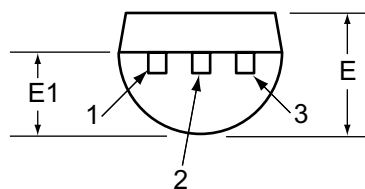

Bottom View

Symbol	A	b	c	D	E	E1	e	e1	L	
Dimensions (inches)	MIN	.170	.014 [†]	.014 [†]	.175	.125	.080	.095	.045	.500
	NOM	-	-	-	-	-	-	-	-	-
	MAX	.210	.022 [†]	.022 [†]	.205	.165	.105	.105	.055	.610*

JEDEC Registration TO-92.

* This dimension is not specified in the JEDEC drawing.

† This dimension differs from the JEDEC drawing.

Drawings not to scale.

Supertex Doc.#: DSPD-3TO92N3, Version E041009.

3-Lead TO-243AA (SOT-89) Package Outline (N8)

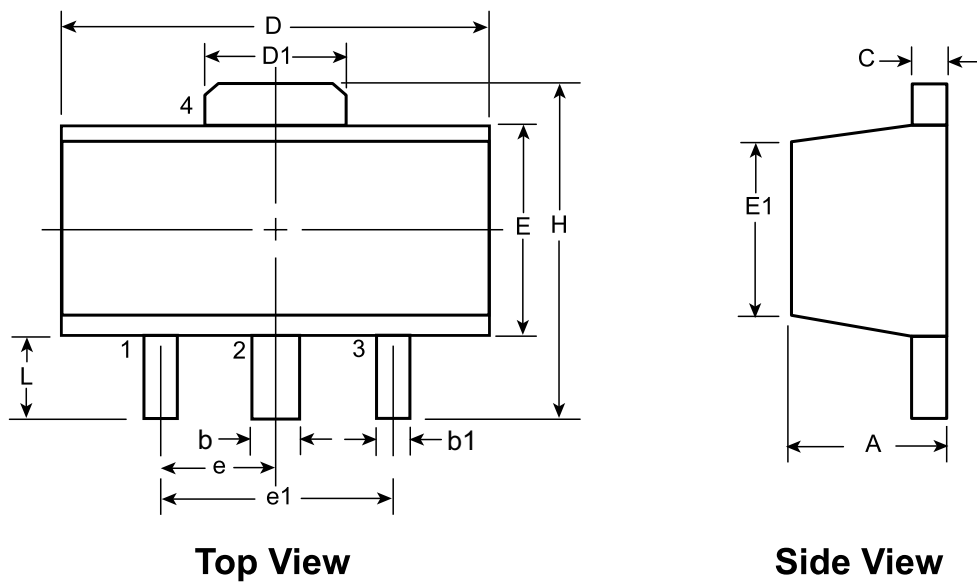

Symbol		A	b	b1	C	D	D1	E	E1	e	e1	H	L	
Dimensions (mm)	MIN	1.40	0.44	0.36	0.35	4.40	1.62	2.29	2.00†	1.50 BSC	3.00 BSC	3.94	0.89	
	NOM	-	-	-	-	-	-	-	-			-	-	-
	MAX	1.60	0.56	0.48	0.44	4.60	1.83	2.60	2.29			4.25	1.20	

JEDEC Registration TO-243, Variation AA, Issue C, July 1986.

† This dimension differs from the JEDEC drawing

Drawings not to scale.

Supertex Doc. #: DSPD-3TO243AAN8, Version E051509.

(The package drawing(s) in this data sheet may not reflect the most current specifications. For the latest package outline information go to <http://www.supertex.com/packaging.html>.)

Supertex inc. does not recommend the use of its products in life support applications, and will not knowingly sell them for use in such applications unless it receives an adequate "product liability indemnification insurance agreement." Supertex inc. does not assume responsibility for use of devices described, and limits its liability to the replacement of the devices determined defective due to workmanship. No responsibility is assumed for possible omissions and inaccuracies. Circuitry and specifications are subject to change without notice. For the latest product specifications refer to the Supertex inc. website: <http://www.supertex.com>.