

### Features

- ✧ For surface mounted application in order to optimize board space
- ✧ Low profile package
- ✧ Built-in strain relief
- ✧ Glass passivated junction
- ✧ Excellent clamping capability
- ✧ Fast response time: Typically less than 1.0ps from 0 volt to BV min
- ✧ Typical  $I_R$  less than 1uA above 10V
- ✧ High temperature soldering guaranteed: 260°C / 10 seconds at terminals
- ✧ Plastic material used carried Underwriters Laboratory Flammability Classification 94V-0
- ✧ 400 watts peak pulse power capability with a 10 / 1000 us waveform
- ✧ Green compound with suffix "G" on packing code & prefix "G" on datecode



### Mechanical Data

- ✧ Case: Molded plastic
- ✧ Terminals: Pure tin plated, lead free
- ✧ Polarity: Indicated by cathode band
- ✧ Packaging: 12mm tape per EIA Std RS-481
- ✧ Weight: 0.064 gram

### Ordering Information (example)

Part No.	Package	Packing	Packing code	Green Compound Packing code
P4SMA11	SMA	1.8K / 7" REEL	R3	R3G

### Maximum Ratings and Electrical Characteristics

Rating at 25 °C ambient temperature unless otherwise specified.

Type Number	Symbol	Value	Unit
Peak Power Dissipation at $T_A=25^\circ\text{C}$ , $T_p=1\text{ms}$ (Note 1)	$P_{PK}$	400	Watts
Peak Forward Surge Current, 8.3ms Single Half Sine-wave Superimposed on Rated Load (JEDEC method)(Note 2)	$I_{FSM}$	40	Amps
Maximum Instantaneous Forward Voltage at 25 A for Unidirectional Only	$V_F$	3.5	Volts
Operating and Storage Temperature Range	$T_J, T_{STG}$	-55 to +150	°C

Note 1: Non-repetitive Current Pulse Per Fig. 3 and Derated above  $T_A=25^\circ\text{C}$  Per Fig. 2

Note 2: Mounted on 5 x 5mm Copper Pads to Each Terminal

### Devices for Bipolar Applications

1. For Bidirectional Use C or CA Suffix for Types P4SMA6.8 through Types P4SMA200A
2. Electrical Characteristics Apply in Both Directions

Version:H12

RATINGS AND CHARACTERISTIC CURVES (P4SMA SERIES)

FIG. 1 PEAK PULSE POWER RATING CURVE

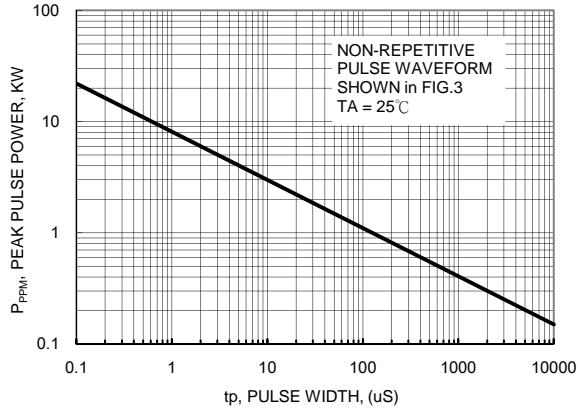

FIG.2 PULSE DERATING CURVE

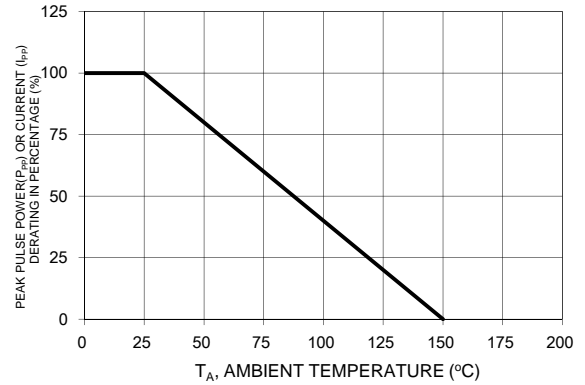

FIG. 3 CLAMPING POWER PULSE WAVEFORM

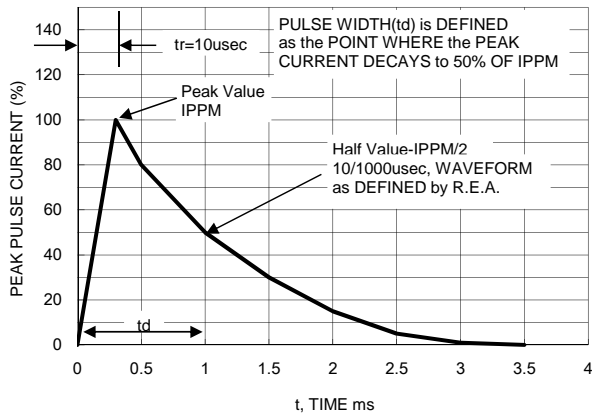

FIG. 4 MAXIMUM NON-REPETITIVE FORWARD SURGE CURRENT UNIDIRECTIONAL ONLY

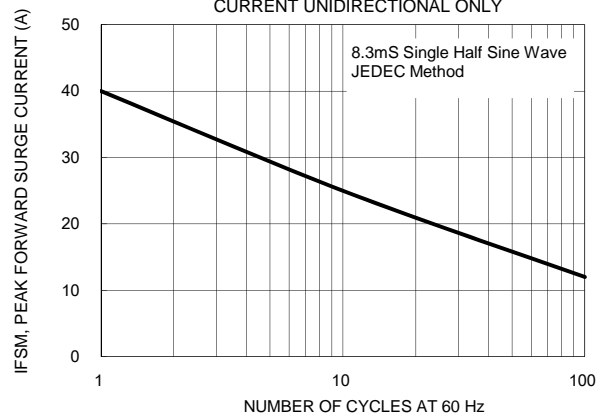
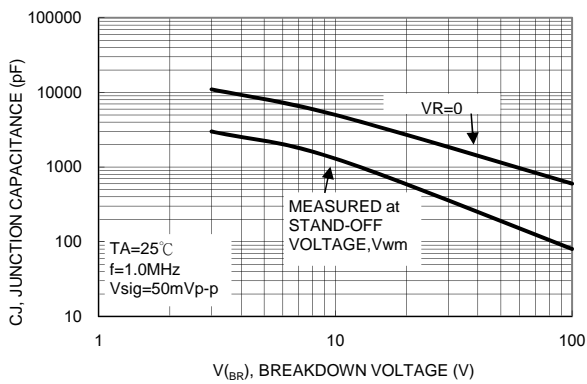

FIG. 5 TYPICAL JUNCTION CAPACITANCE



**ELECTRICAL CHARACTERISTICS (TA=25°C unless otherwise noted)**

Device	Device Marking Code	Breakdown Voltage VBR (V) (Note 1)		Test Current IT (mA)	Stand-Off Voltage V <sub>WM</sub> (V)	Maximum Reverse Leakage @ V <sub>WM</sub> ID (uA)	Maximum Peak Pulse Current IPPM (A) (Note 2)	Maximum Clamping Voltage @ IPPM Vc(V)	Maximum Temperature Coefficient of VBR(%/°C)
		Min	Max						
P4SMA6.8	ADJ	6.12	7.48	10	5.50	1000	38.0	10.8	0.057
P4SMA6.8A	AEJ	6.46	7.14	10	5.80	1000	40.0	10.5	0.057
P4SMA7.5	AFJ	6.75	8.25	10	6.05	500	35.0	11.7	0.061
P4SMA7.5A	AGJ	7.13	7.88	10	6.40	500	37.0	11.3	0.061
P4SMA8.2	AHJ	7.38	9.02	10	6.63	200	33.0	12.5	0.065
P4SMA8.2A	AKJ	7.79	8.61	10	7.02	200	34.0	12.1	0.065
P4SMA9.1	ALJ	8.19	10.00	1.0	7.37	50	30.0	13.8	0.068
P4SMA9.1A	AMJ	8.65	9.55	1.0	7.78	50	31.0	13.4	0.068
P4SMA10	ANJ	9.00	11.00	1.0	8.10	10	28.0	15.0	0.073
P4SMA10A	APJ	9.50	10.5	1.0	8.55	10	29.0	14.5	0.073
P4SMA11	AQJ	9.90	12.1	1.0	8.92	5.0	26.0	16.2	0.075
P4SMA11A	ARJ	10.5	11.6	1.0	9.40	5.0	27.0	15.6	0.075
P4SMA12	ASJ	10.8	13.2	1.0	9.72	5.0	24.0	17.3	0.078
P4SMA12A	ATJ	11.4	12.6	1.0	10.2	5.0	25.0	16.7	0.078
P4SMA13	AUJ	11.7	14.3	1.0	10.5	5.0	22.0	19.0	0.081
P4SMA13A	AVJ	12.4	13.7	1.0	11.1	5.0	23.0	18.2	0.081
P4SMA15	AWJ	13.5	16.5	1.0	12.1	5.0	19.0	22.0	0.084
P4SMA15A	AXJ	14.3	15.8	1.0	12.8	5.0	20.0	21.2	0.084
P4SMA16	AYJ	14.4	17.6	1.0	12.9	5.0	17.8	23.5	0.086
P4SMA16A	AZJ	15.2	16.8	1.0	13.6	5.0	18.6	22.5	0.086
P4SMA18	BDJ	16.2	19.8	1.0	14.5	5.0	16.0	26.5	0.088
P4SMA18A	BEJ	17.1	18.9	1.0	15.3	5.0	16.5	25.5	0.088
P4SMA20	BFJ	18.0	22.0	1.0	16.2	5.0	14.0	29.1	0.090
P4SMA20A	BGJ	19.0	21.0	1.0	17.1	5.0	15.0	27.7	0.090
P4SMA22	BHJ	19.8	24.2	1.0	17.8	5.0	13.0	31.9	0.092
P4SMA22A	BKJ	20.9	23.1	1.0	18.8	5.0	13.7	30.6	0.092
P4SMA24	BLJ	21.6	26.4	1.0	19.4	5.0	12.0	34.7	0.094
P4SMA24A	BMJ	22.8	25.2	1.0	20.5	5.0	12.6	33.2	0.094
P4SMA27	BNJ	24.3	29.7	1.0	21.8	5.0	10.7	39.1	0.096
P4SMA27A	BPJ	25.7	28.4	1.0	23.1	5.0	11.0	37.5	0.096
P4SMA30	BQJ	27.0	33.0	1.0	24.3	5.0	9.6	43.5	0.097
P4SMA30A	BRJ	28.5	31.5	1.0	25.6	5.0	10.0	41.4	0.097
P4SMA33	BSJ	29.7	36.3	1.0	26.8	5.0	8.8	47.7	0.098
P4SMA33A	BTJ	31.4	34.7	1.0	28.2	5.0	9.0	45.7	0.098
P4SMA36	BUJ	32.4	39.6	1.0	29.1	5.0	8.0	52.0	0.099
P4SMA36A	BVJ	34.2	37.8	1.0	30.8	5.0	8.4	49.9	0.099
P4SMA39	BWJ	35.1	42.9	1.0	31.6	5.0	7.4	56.4	0.100
P4SMA39A	BXJ	37.1	41.0	1.0	33.3	5.0	7.7	53.9	0.100
P4SMA43	BYJ	38.7	47.3	1.0	34.8	5.0	6.7	61.9	0.101
P4SMA43A	BZJ	40.9	45.2	1.0	36.8	5.0	7.0	59.3	0.101
P4SMA47	CDJ	42.3	51.7	1.0	38.1	5.0	6.2	67.8	0.101
P4SMA47A	CEJ	44.7	49.4	1.0	40.2	5.0	6.4	64.8	0.101
P4SMA51	CFJ	45.9	56.1	1.0	41.3	5.0	5.7	73.5	0.102
P4SMA51A	CGJ	48.5	53.6	1.0	43.6	5.0	6.0	70.1	0.102
P4SMA56	CHJ	50.4	61.6	1.0	45.4	5.0	5.2	80.5	0.103
P4SMA56A	CKJ	53.2	58.8	1.0	47.8	5.0	5.4	77.0	0.103
P4SMA62	CLJ	55.8	68.2	1.0	50.2	5.0	4.7	89.0	0.104
P4SMA62A	CMJ	58.9	65.1	1.0	53.0	5.0	5.0	85.0	0.104
P4SMA68	CNJ	61.2	74.8	1.0	55.1	5.0	4.2	98.0	0.104
P4SMA68A	CPJ	64.6	71.4	1.0	58.1	5.0	4.5	92.0	0.104

**ELECTRICAL CHARACTERISTICS (TA=25°C unless otherwise noted)**

Device	Device Marking Code	Breakdown Voltage VBR (V) (Note 1)		Test Current IT (mA)	Stand-Off Voltage V <sub>WM</sub> (V)	Maximum Reverse Leakage @ V <sub>WM</sub> ID (uA)	Maximum Peak Pulse Current IPPM (A) (Note 2)	Maximum Clamping Voltage @ IPPM Vc(V)	Maximum Temperature Coefficient of VBR(%/°C)
		Min	Max						
P4SMA75	CQJ	67.5	82.5	1.0	60.7	5.0	3.8	108	0.105
P4SMA75A	CRJ	71.3	78.8	1.0	64.1	5.0	4.0	103	0.105
P4SMA82	CSJ	73.8	90.2	1.0	66.4	5.0	3.5	118	0.105
P4SMA82A	CTJ	77.9	86.1	1.0	70.1	5.0	3.7	113	0.105
P4SMA91	CUJ	81.9	100	1.0	73.7	5.0	3.2	131	0.106
P4SMA91A	CVJ	86.5	95.5	1.0	77.8	5.0	3.3	125	0.106
P4SMA100	CWJ	90	110	1.0	81.0	5.0	2.9	144	0.106
P4SMA100A	CXJ	95	105	1.0	85.5	5.0	3.0	137	0.106
P4SMA110	CYJ	99	121	1.0	89.2	5.0	2.6	158	0.107
P4SMA110A	CZJ	105	116	1.0	94.0	5.0	2.7	152	0.107
P4SMA120	RDJ	108	132	1.0	97.2	5.0	2.4	173	0.107
P4SMA120A	REJ	114	126	1.0	102.0	5.0	2.5	165	0.107
P4SMA130	RFJ	117	143	1.0	105.0	5.0	2.2	187	0.107
P4SMA130A	RGJ	124	137	1.0	111.0	5.0	2.3	179	0.107
P4SMA150	RHJ	135	165	1.0	121.0	5.0	1.9	215	0.108
P4SMA150A	RKJ	143	158	1.0	128.0	5.0	2.0	207	0.108
P4SMA160	RLJ	144	176	1.0	130.0	5.0	1.8	230	0.108
P4SMA160A	RMJ	152	168	1.0	136.0	5.0	1.9	219	0.108
P4SMA170	RNJ	153	187	1.0	138.0	5.0	1.7	244	0.108
P4SMA170A	RPJ	162	179	1.0	145.0	5.0	1.8	234	0.108
P4SMA180	RQJ	162	198	1.0	146.0	5.0	1.6	258	0.108
P4SMA180A	RRJ	171	189	1.0	154.0	5.0	1.7	246	0.108
P4SMA200	RSJ	180	220	1.0	162.0	5.0	1.4	287	0.108
P4SMA200A	RTJ	190	210	1.0	171.0	5.0	1.51	274	0.108

**Notes:**

1. V<sub>BR</sub> measure after I<sub>T</sub> applied for 300us, I<sub>T</sub>=square wave pulse or equivalent.
2. Surge current waveform per Figure. 3 and derate per Figure. 2.
3. For bipolar types having V<sub>WM</sub> of 10 volts and under, the I<sub>p</sub> limit is doubled.
4. For bidirectional use C or CA suffix for types PS4MA6.8 through P4SMA200A.
5. All terms and symbols are consistent with ANSI/IEEE C62.35.

**Ordering information**

Part No.	Package	Packing	Packing code	Green Compound Packing code
P4SMAxx (Note)	SMA	1.8K / 7" REEL	R3	R3G
	SMA	7.5K / 13" REEL	R2	R2G
	SMA	7.5K / 13" REEL	M2	M2G
	Folded SMA	1.8K / 7" REEL	F3	F3G
	Folded SMA	7.5K / 13" REEL	F2	F2G
	Folded SMA	7.5K / 13" REEL	F4	F4G
	C SMA	1.8K / 7" REEL	E3	E3G
	C SMA	7.5K / 13" REEL	E2	E2G
C SMA	7.5K / 13" REEL	E4	E4G	

Note: "x" is Device Code from "6.8" thru "200".

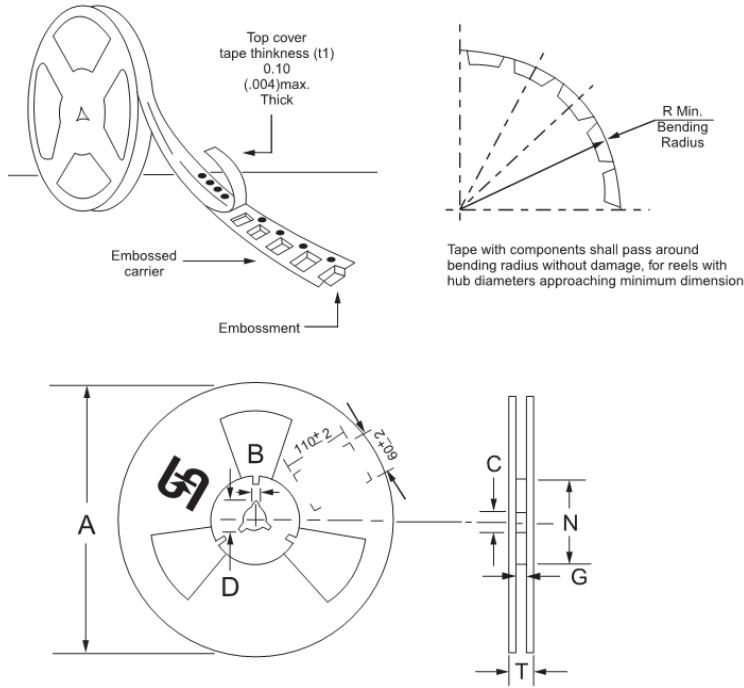
**Tape & Reel specification**

Reel Size	Tape Size	A	B	C	D	N	G	T
		±2.0	±0.4	+0.5;-0.2	min	±1.0	+0.8;-0	max
7"	12mm	178	1.9	13	21	62	12.2	14.6
Reel Size	Tape Size	A	B	C	D	N	G	T
		max	±0.5	±0.5	min	±0.5	+2.0;-0	max
13"	12mm	330	2	13	20.2	75	12.4	18.4

Unit (mm)

### Suggested PAD Layout

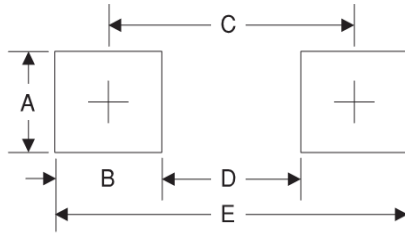

Symbol	Unit(mm)
A	1.78
B	1.51
C	3.92
D	2.41
E	4.43

### Package Outline Dimensions

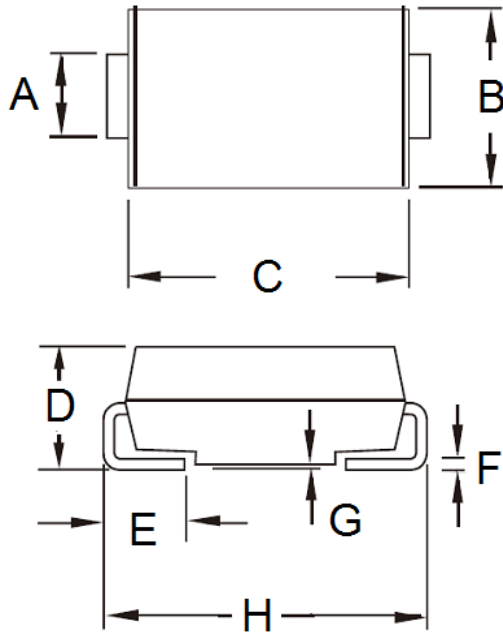

DIM.	Unit(mm)		Unit(inch)	
	Min	Max	Min	Max
A	1.27	1.58	0.050	0.062
B	2.29	2.83	0.090	0.111
C	4.06	4.60	0.160	0.181
D	1.99	2.50	0.078	0.098
E	0.90	1.41	0.035	0.056
F	0.15	0.31	0.006	0.012
G	0.10	0.20	0.004	0.008
H	4.95	5.33	0.195	0.210

### Marking Diagram



P/N = Specific Device Code  
 G = Green Compound  
 YW = Date Code