

# HEXFRED<sup>®</sup>, Ultrafast Soft Recovery Diode, 4 A

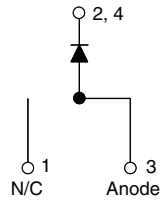

D-PAK (TO-252AA)

**FEATURES**

- Ultrafast recovery time
- Ultrasoft recovery
- Very low  $I_{RRM}$
- Very low  $Q_{rr}$
- Guaranteed avalanche
- Specified at operating temperature
- AEC-Q101 qualified
- Meets JESD 201 class 1A whisker test
- Meets MSL level 1, per J-STD-020, LF maximum peak of 260 °C
- Material categorization: For definitions of compliance please see [www.vishay.com/doc?99912](http://www.vishay.com/doc?99912)

**RoHS**  
COMPLIANT  
HALOGEN  
**FREE**
**PRODUCT SUMMARY**

Package	TO-252AA (D-PAK)
$I_{F(AV)}$	4 A
$V_R$	600 V
$V_F$ at $I_F$	1.8 V
$t_{rr}$ typ.	17 ns
$T_J$ max.	150 °C
Diode variation	Single die

**BENEFITS**

- Reduced RFI and EMI
- Reduced power loss in diode and switching transistor
- Higher frequency operation
- Reduced snubbing
- Reduced parts count

**DESCRIPTION/APPLICATIONS**

These diodes are optimized to reduce losses and EMI/RFI in high frequency power conditioning systems. The softness of the recovery eliminates the need for a snubber in most applications. These devices are ideally suited for freewheeling, flyback, power converters, motor drives, and other applications where high speed and reduced switching losses are design requirements.

**ABSOLUTE MAXIMUM RATINGS**

PARAMETER	SYMBOL	TEST CONDITIONS	VALUES	UNITS
Cathode to anode voltage	$V_{RRM}$		600	V
Maximum continuous forward current	$I_{F(AV)}$	$T_C = 100\text{ °C}$	4	A
Single pulse forward current	$I_{FSM}$		25	
Repetitive peak forward current	$I_{FRM}$	$T_C = 116\text{ °C}$	16	
Maximum power dissipation	$P_D$	$T_C = 100\text{ °C}$	10	W
Operating junction and storage temperatures	$T_J, T_{Stg}$		- 55 to 150	°C

**ELECTRICAL SPECIFICATIONS ( $T_J = 25\text{ °C}$  unless otherwise specified)**

PARAMETER	SYMBOL	TEST CONDITIONS	MIN.	TYP.	MAX.	UNITS
Breakdown voltage, blocking voltage	$V_{BR}, V_R$	$I_R = 100\text{ }\mu\text{A}$	600	-	-	V
Forward voltage See fig. 1	$V_F$	$I_F = 4\text{ A}$	-	1.5	1.8	
		$I_F = 8\text{ A}$	-	1.8	2.2	
		$I_F = 4\text{ A}, T_J = 125\text{ °C}$	-	1.4	1.7	
Maximum reverse leakage current	$I_R$	$V_R = V_R$ rated	-	0.17	3.0	$\mu\text{A}$
		$T_J = 125\text{ °C}, V_R = 0.8 \times V_R$ rated	-	44	300	
Junction capacitance	$C_T$	$V_R = 200\text{ V}$	-	4	8	pF
Series inductance	$L_S$	Measured lead to lead 5 mm from package body	-	8.0	-	nH



DYNAMIC RECOVERY CHARACTERISTICS ( $T_C = 25\text{ }^\circ\text{C}$ unless otherwise specified)						
PARAMETER	SYMBOL	TEST CONDITIONS	MIN.	TYP.	MAX.	UNITS
Reverse recovery time	$t_{rr}$	$I_F = 1.0\text{ A}$ , $dI_F/dt = 200\text{ A}/\mu\text{A}$ , $V_R = 30\text{ V}$	-	17	-	ns
		$T_J = 25\text{ }^\circ\text{C}$	-	28	42	
		$T_J = 125\text{ }^\circ\text{C}$	-	38	57	
Peak recovery current	$I_{RRM}$	$T_J = 25\text{ }^\circ\text{C}$	-	2.9	5.2	A
		$T_J = 125\text{ }^\circ\text{C}$	-	3.7	6.7	
Reverse recovery charge	$Q_{rr}$	$T_J = 25\text{ }^\circ\text{C}$	-	40	60	nC
		$T_J = 125\text{ }^\circ\text{C}$	-	70	105	
Rate of fall of recovery current	$dI_{(rec)M}/dt$	$T_J = 25\text{ }^\circ\text{C}$	-	280	-	A/ $\mu\text{s}$
		$T_J = 125\text{ }^\circ\text{C}$	-	235	-	

THERMAL - MECHANICAL SPECIFICATIONS						
PARAMETER	SYMBOL	TEST CONDITIONS	MIN.	TYP.	MAX.	UNITS
Maximum junction and storage temperature range	$T_J$ , $T_{Stg}$		- 55	-	150	$^\circ\text{C}$
Thermal resistance, junction to case	$R_{thJC}$		-	-	5.0	$^\circ\text{C}/\text{W}$
Thermal resistance, junction to ambient	$R_{thJA}$	Typical socket mount	-	-	80	
Weight			-	2.0	-	g
			-	0.07	-	oz.
Mounting torque			6.0 (5.0)	-	12 (10)	kgf · cm (lbf · in)
Marking device		Case style D-PAK	HFA04SD60SH			

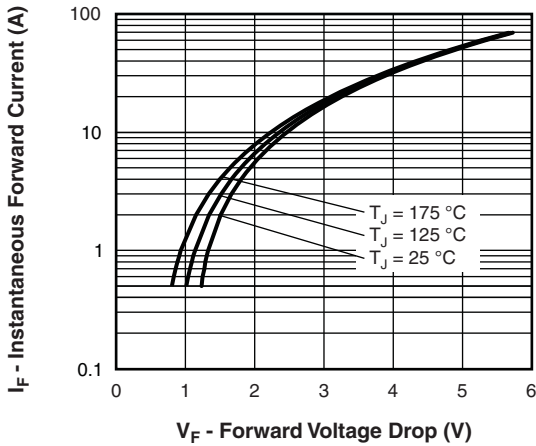

Fig. 1 - Typical Forward Voltage Drop Characteristics

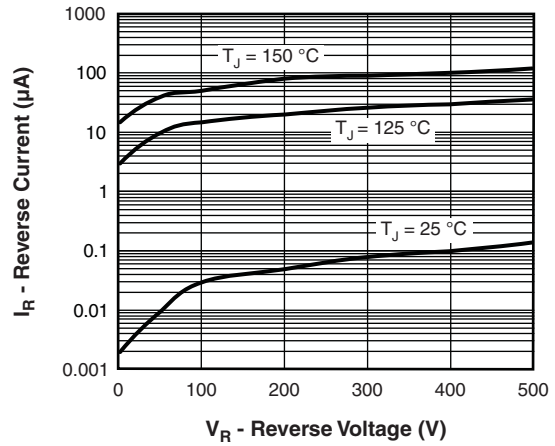

Fig. 2 - Typical Values of Reverse Current vs. Reverse Voltage

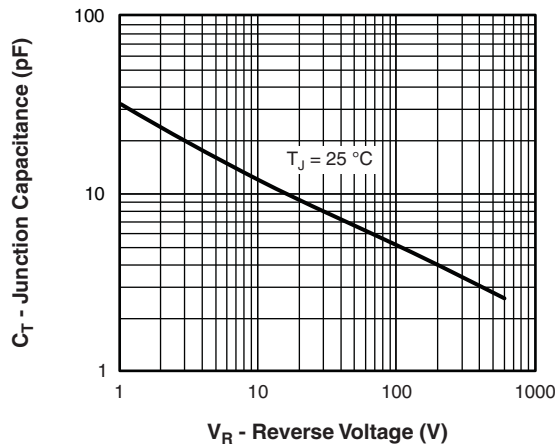

Fig. 3 - Typical Junction Capacitance vs. Reverse Voltage

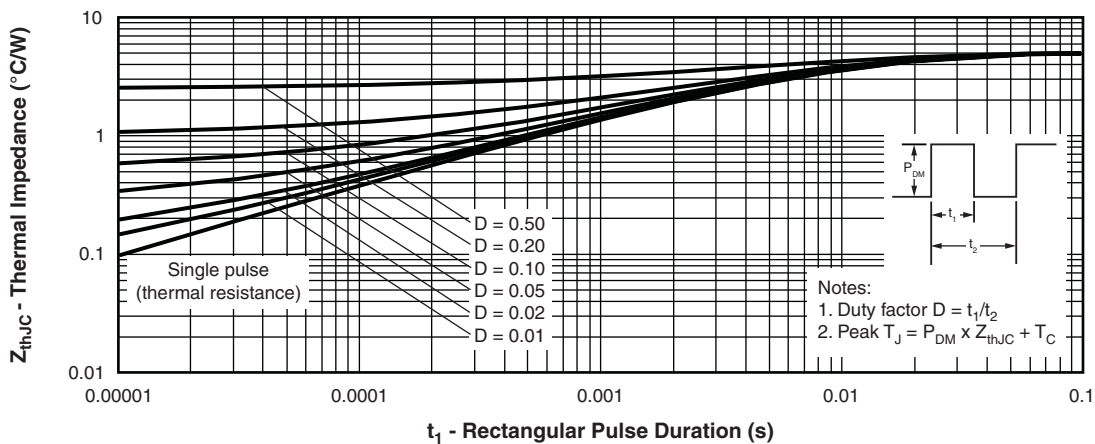

Fig. 4 - Maximum Thermal Impedance  $Z_{thJC}$  Characteristics

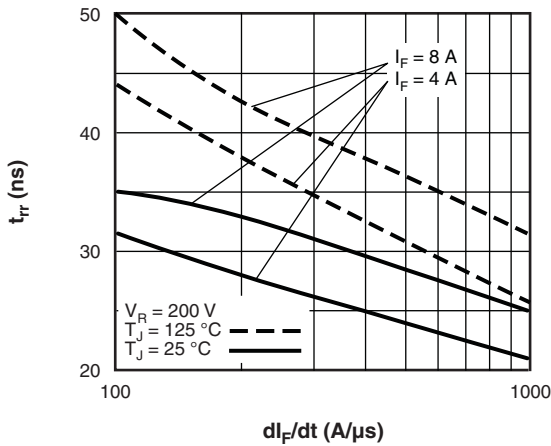

Fig. 5 - Typical Reverse Recovery Time vs.  $di_F/dt$

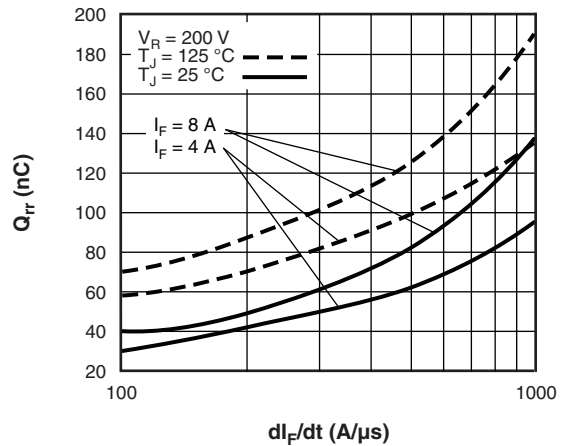

Fig. 7 - Typical Stored Charge vs.  $di_F/dt$

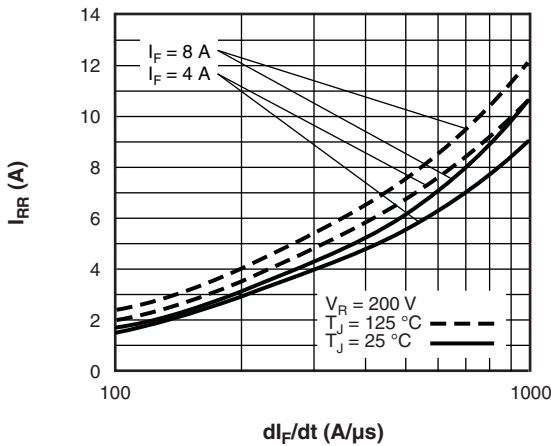

Fig. 6 - Typical Recovery Current vs.  $di_F/dt$

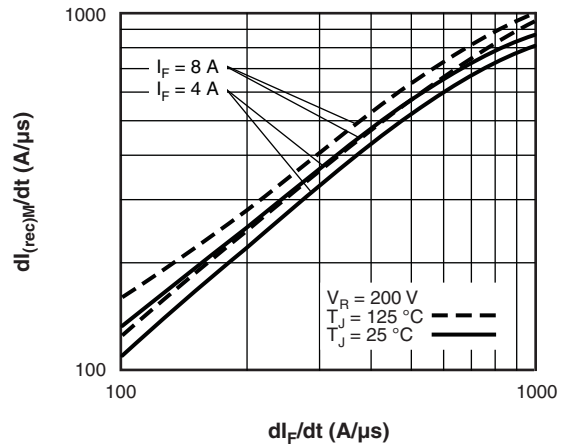

Fig. 8 - Typical  $di_{(rec)M}/dt$  vs.  $di_F/dt$

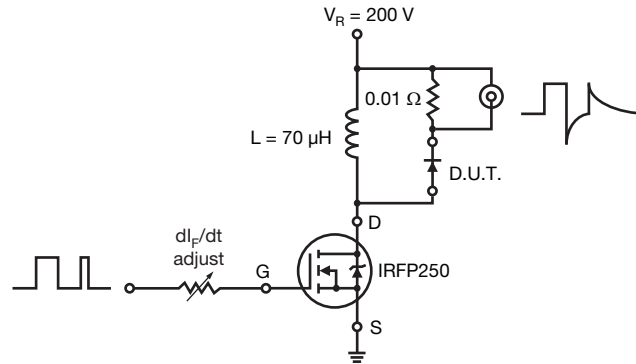
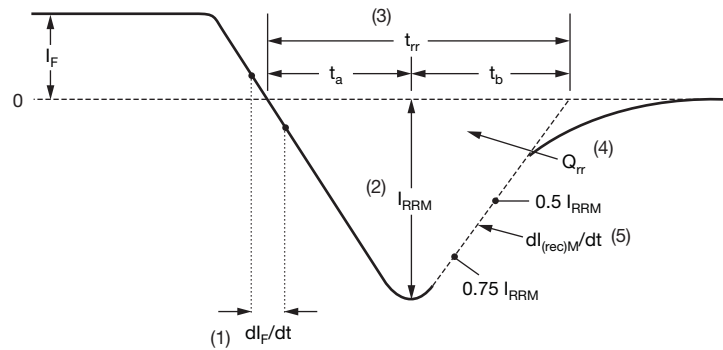

Fig. 9 - Reverse Recovery Parameter Test Circuit



- |   |   |
|---|---|
| <p>(1) <math>di_F/dt</math> - rate of change of current through zero crossing</p> <p>(2) <math>I_{RRM}</math> - peak reverse recovery current</p> <p>(3) <math>t_{rr}</math> - reverse recovery time measured from zero crossing point of negative going <math>I_F</math> to point where a line passing through <math>0.75 I_{RRM}</math> and <math>0.50 I_{RRM}</math> extrapolated to zero current.</p> | <p>(4) <math>Q_{rr}</math> - area under curve defined by <math>t_{rr}</math> and <math>I_{RRM}</math></p> $Q_{rr} = \frac{t_{rr} \times I_{RRM}}{2}$ <p>(5) <math>dl_{(rec)M}/dt</math> - peak rate of change of current during <math>t_b</math> portion of <math>t_{rr}</math></p> |
|---|---|

Fig. 10 - Reverse Recovery Waveform and Definitions



## ORDERING INFORMATION TABLE

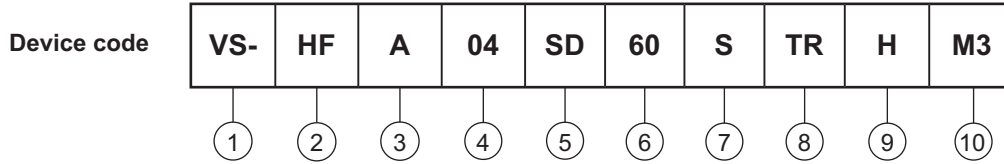

- 1** - Vishay Semiconductors product
- 2** - HEXFRED® family
- 3** - Electron irradiated
- 4** - Current rating (04 = 4 A)
- 5** - D-PAK
- 6** - Voltage rating (60 = 600 V)
- 7** - S = D-PAK
- 8** -
  - TR = Tape and reel
  - R = Tape and reel (right oriented)
  - L = Tape and reel (left oriented)
- 9** - H = AEC-Q101 qualified
- 10** - Environmental digit:
  - M3 = Halogen-free, RoHS-compliant, and terminations lead (Pb)-free

ORDERING INFORMATION (Example)			
PREFERRED P/N	QUANTITY PER T/R	MINIMUM ORDER QUANTITY	PACKAGING DESCRIPTION
VS-HFA04SD60SHM3	75	3000	Antistatic plastic tube
VS-HFA04SD60STRHM3	2000	2000	13" diameter reel
VS-HFA04SD60STRRHM3	3000	3000	13" diameter reel
VS-HFA04SD60STRLHM3	3000	3000	13" diameter reel

LINKS TO RELATED DOCUMENTS	
Dimensions	<a href="http://www.vishay.com/doc?95519">www.vishay.com/doc?95519</a>
Part marking information	<a href="http://www.vishay.com/doc?95518">www.vishay.com/doc?95518</a>
Packaging information	<a href="http://www.vishay.com/doc?95033">www.vishay.com/doc?95033</a>



## Disclaimer

ALL PRODUCT, PRODUCT SPECIFICATIONS AND DATA ARE SUBJECT TO CHANGE WITHOUT NOTICE TO IMPROVE RELIABILITY, FUNCTION OR DESIGN OR OTHERWISE.

Vishay Intertechnology, Inc., its affiliates, agents, and employees, and all persons acting on its or their behalf (collectively, "Vishay"), disclaim any and all liability for any errors, inaccuracies or incompleteness contained in any datasheet or in any other disclosure relating to any product.

Vishay makes no warranty, representation or guarantee regarding the suitability of the products for any particular purpose or the continuing production of any product. To the maximum extent permitted by applicable law, Vishay disclaims (i) any and all liability arising out of the application or use of any product, (ii) any and all liability, including without limitation special, consequential or incidental damages, and (iii) any and all implied warranties, including warranties of fitness for particular purpose, non-infringement and merchantability.

Statements regarding the suitability of products for certain types of applications are based on Vishay's knowledge of typical requirements that are often placed on Vishay products in generic applications. Such statements are not binding statements about the suitability of products for a particular application. It is the customer's responsibility to validate that a particular product with the properties described in the product specification is suitable for use in a particular application. Parameters provided in datasheets and/or specifications may vary in different applications and performance may vary over time. All operating parameters, including typical parameters, must be validated for each customer application by the customer's technical experts. Product specifications do not expand or otherwise modify Vishay's terms and conditions of purchase, including but not limited to the warranty expressed therein.

Except as expressly indicated in writing, Vishay products are not designed for use in medical, life-saving, or life-sustaining applications or for any other application in which the failure of the Vishay product could result in personal injury or death. Customers using or selling Vishay products not expressly indicated for use in such applications do so at their own risk and agree to fully indemnify and hold Vishay and its distributors harmless from and against any and all claims, liabilities, expenses and damages arising or resulting in connection with such use or sale, including attorneys fees, even if such claim alleges that Vishay or its distributor was negligent regarding the design or manufacture of the part. Please contact authorized Vishay personnel to obtain written terms and conditions regarding products designed for such applications.

No license, express or implied, by estoppel or otherwise, to any intellectual property rights is granted by this document or by any conduct of Vishay. Product names and markings noted herein may be trademarks of their respective owners.

## Material Category Policy

**Vishay Intertechnology, Inc. hereby certifies that all its products that are identified as RoHS-Compliant fulfill the definitions and restrictions defined under Directive 2011/65/EU of The European Parliament and of the Council of June 8, 2011 on the restriction of the use of certain hazardous substances in electrical and electronic equipment (EEE) - recast, unless otherwise specified as non-compliant.**

**Please note that some Vishay documentation may still make reference to RoHS Directive 2002/95/EC. We confirm that all the products identified as being compliant to Directive 2002/95/EC conform to Directive 2011/65/EU.**