

# BZX100A

Single Zener diode

Rev. 01 — 30 May 2007

Product data sheet

## 1. Product profile

### 1.1 General description

General-purpose Zener diode in a SOD323F (SC-90) very small and flat lead Surface-Mounted Device (SMD) plastic package.

### 1.2 Features

- Non-repetitive peak reverse power dissipation:  $\leq 60$  W
- Small plastic package suitable for surface-mounted design

### 1.3 Applications

- General regulation functions
- Overvoltage protection for ElectroLuminescent (EL) driver circuits
- AEC-Q101 qualified

### 1.4 Quick reference data

Table 1. Quick reference data

Symbol	Parameter	Conditions	Min	Typ	Max	Unit
$V_Z$	working voltage	$I_Z = 1$ mA	95	-	105	V
$I_{ZSM}$	non-repetitive peak reverse current		[1]	-	0.5	A

[1]  $t_p = 100$   $\mu$ s; square wave;  $T_j = 25$  °C prior to surge

## 2. Pinning information

Table 2. Pinning

Pin	Description	Simplified outline	Symbol
1	cathode	[1]	
2	anode		

[1] The marking bar indicates the cathode.

### 3. Ordering information

Table 3. Ordering information

Type number	Package		Version
	Name	Description	
BZX100A	SC-90	plastic surface-mounted package; 2 leads	SOD323F

### 4. Marking

Table 4. Marking codes

Type number	Marking code
BZX100A	AS

### 5. Limiting values

Table 5. Limiting values

In accordance with the Absolute Maximum Rating System (IEC 60134).

Symbol	Parameter	Conditions	Min	Max	Unit
$I_F$	forward current		-	0.2	A
$I_{ZSM}$	non-repetitive peak reverse current		[1]	0.5	A
$P_{ZSM}$	non-repetitive peak reverse power dissipation		[1]	60	W
$P_{tot}$	total power dissipation	$T_{amb} \leq 25\text{ °C}$	[2]	310	mW
			[3]	550	mW
			[4]	1	W
$T_j$	junction temperature		-	150	°C
$T_{amb}$	ambient temperature		-65	+150	°C
$T_{stg}$	storage temperature		-65	+150	°C

[1]  $t_p = 100\ \mu\text{s}$ ; square wave;  $T_j = 25\text{ °C}$  prior to surge

[2] Device mounted on an FR4 Printed-Circuit Board (PCB), single-sided copper, tin-plated and standard footprint.

[3] Device mounted on an FR4 PCB, single-sided copper, tin-plated, mounting pad for cathode  $1\text{ cm}^2$ .

[4] Device mounted on a ceramic PCB,  $\text{Al}_2\text{O}_3$ , standard footprint.

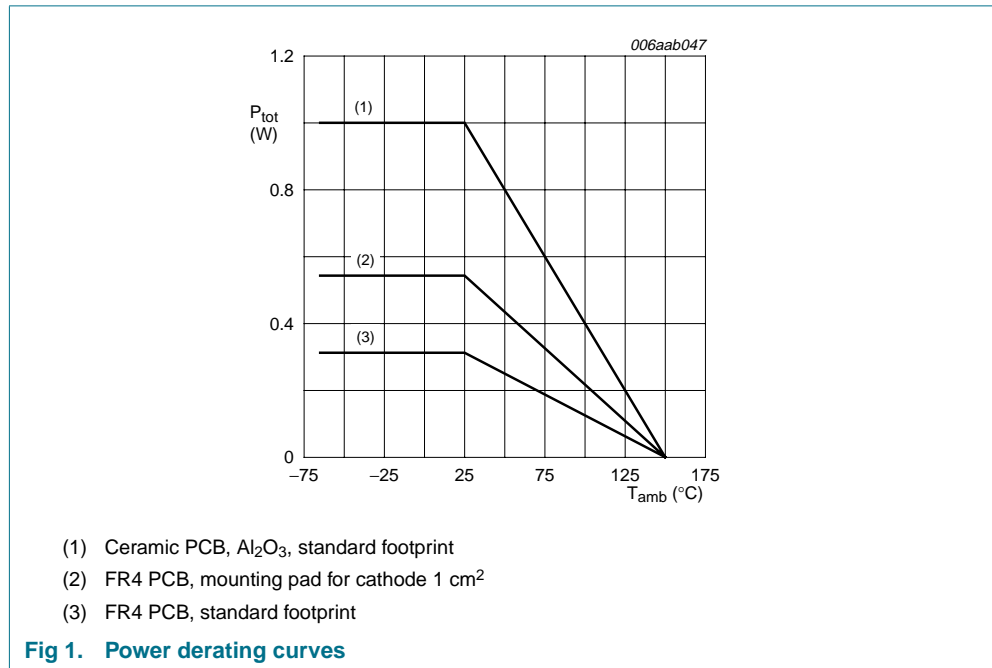

## 6. Thermal characteristics

**Table 6. Thermal characteristics**

Symbol	Parameter	Conditions	Min	Typ	Max	Unit	
R <sub>th(j-a)</sub>	thermal resistance from junction to ambient	in free air	[1]	-	-	400	K/W
			[2]	-	-	230	K/W
			[3]	-	-	125	K/W
R <sub>th(j-sp)</sub>	thermal resistance from junction to solder point		[4]	-	-	55	K/W

- [1] Device mounted on an FR4 PCB, single-sided copper, tin-plated and standard footprint.
- [2] Device mounted on an FR4 PCB, single-sided copper, tin-plated, mounting pad for cathode 1 cm<sup>2</sup>.
- [3] Device mounted on a ceramic PCB, Al<sub>2</sub>O<sub>3</sub>, standard footprint.
- [4] Soldering point of cathode tab.

## 7. Characteristics

**Table 7. Characteristics**

$T_j = 25\text{ }^\circ\text{C}$  unless otherwise specified.

Symbol	Parameter	Conditions	Min	Typ	Max	Unit
$V_F$	forward voltage		[1]			
		$I_F = 10\text{ mA}$	-	-	0.9	V
		$I_F = 100\text{ mA}$	-	-	1.1	V
$V_Z$	working voltage	$I_Z = 1\text{ mA}$	95	-	105	V
$r_{dif}$	differential resistance	$I_Z = 1\text{ mA}$	-	-	700	$\Omega$
$I_R$	reverse current	$V_R = 76\text{ V}$	-	-	0.2	$\mu\text{A}$
$S_Z$	temperature coefficient	$I_Z = 1\text{ mA}$	-	138	-	mV/K
$C_d$	diode capacitance	$f = 1\text{ MHz};$ $V_R = 0\text{ V}$	-	-	70	pF

[1] Pulse test:  $t_p \leq 300\text{ }\mu\text{s}; \delta \leq 0.02$ .

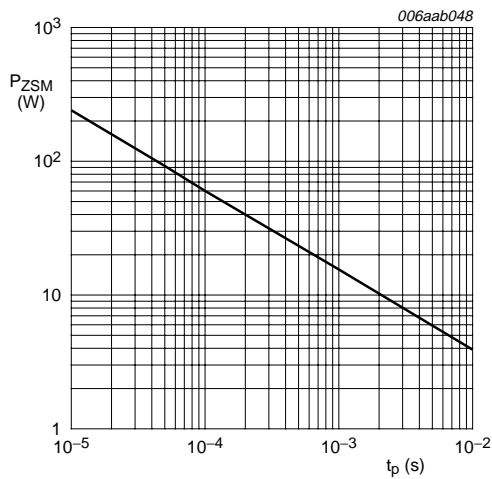

$T_j = 25\text{ }^\circ\text{C}$  (prior to surge)

**Fig 2. Non-repetitive peak reverse power dissipation as a function of pulse duration; maximum values**

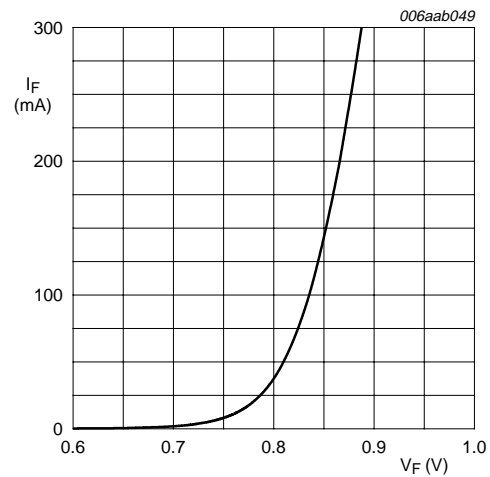

$T_j = 25\text{ }^\circ\text{C}$

**Fig 3. Forward current as a function of forward voltage; typical values**

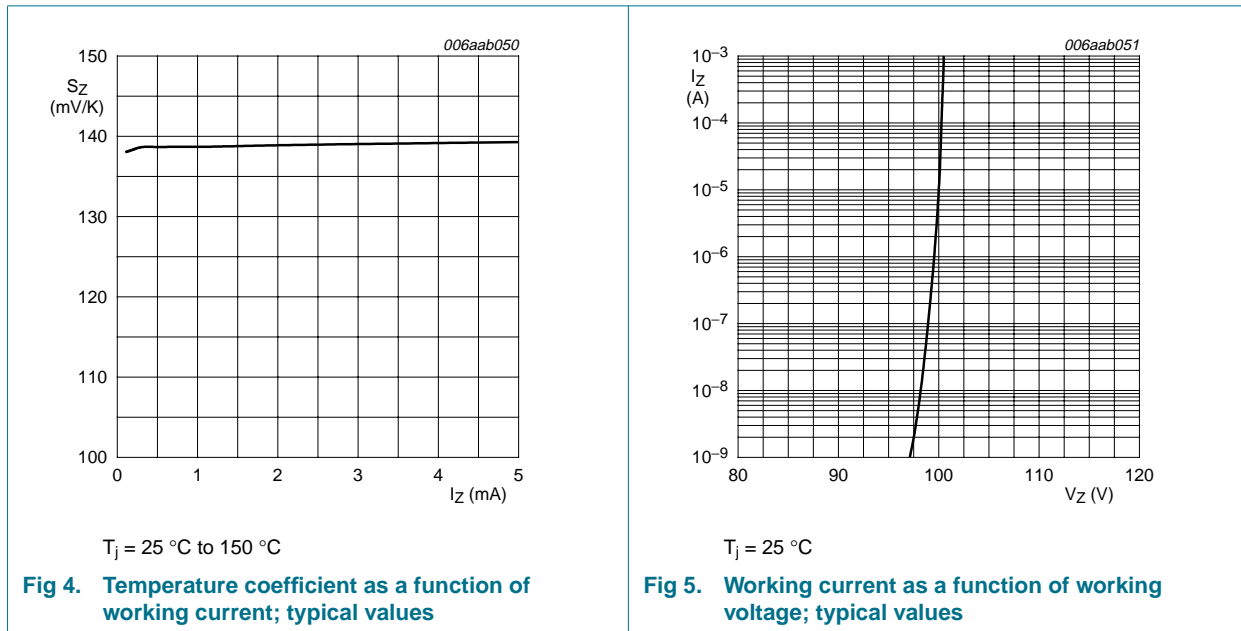

## 8. Application information

High-voltage Zener diodes can be used as overvoltage protection diodes for Integrated Circuits (IC) due to their ability to cut off the applied voltage at a well-defined value. One important application is the protection of EL driver circuits where a driver IC is connected to an EL foil. Since both the foil as well as the IC are sensitive against voltage overstress, it is necessary to install an additional protection device in the circuit. Commonly, a peak-to-peak voltage of 220 V should not be exceeded, such that two 100 V diodes in back-to-back configuration are used.

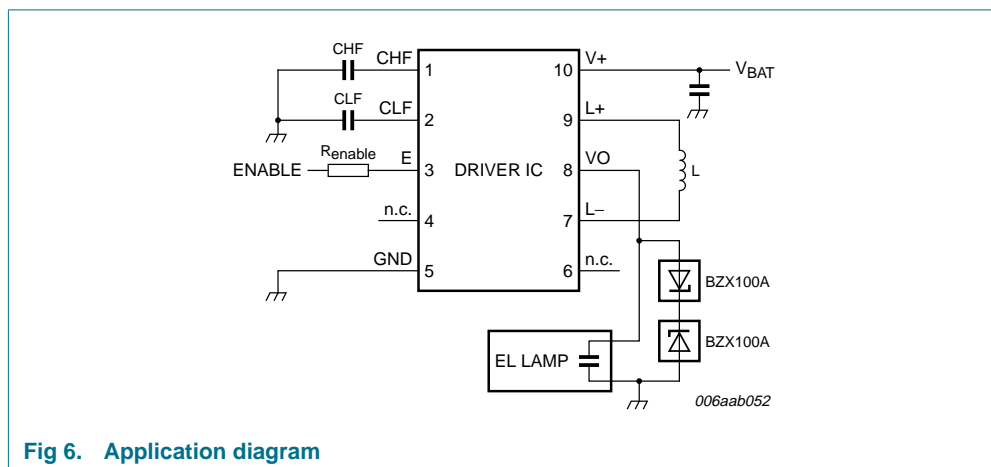

**Fig 6. Application diagram**

## 9. Test information

### 9.1 Quality information

This product has been qualified in accordance with the Automotive Electronics Council (AEC) standard Q101 (Stress qualification for discrete semiconductors) and is suitable for use in automotive critical applications.

## 10. Package outline

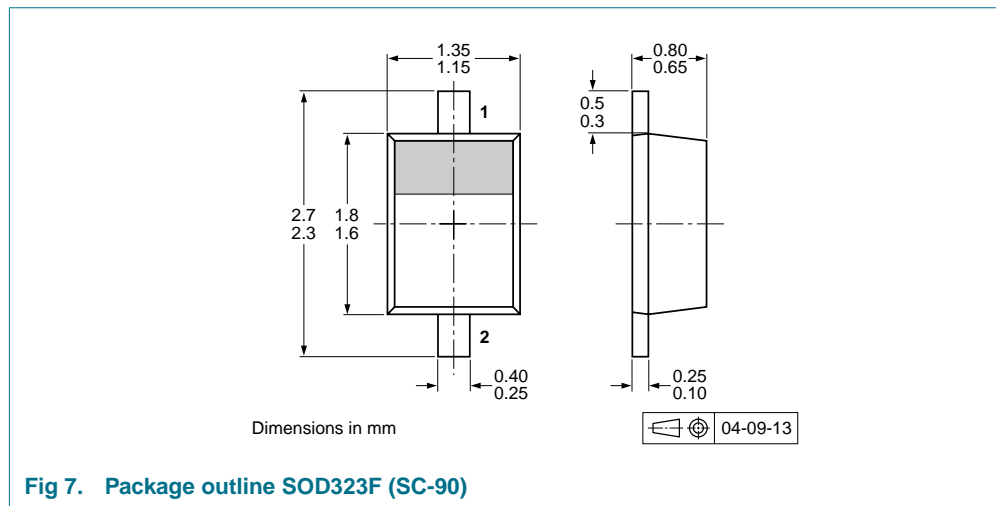

Fig 7. Package outline SOD323F (SC-90)

## 11. Packing information

**Table 8. Packing methods**

The indicated -xxx are the last three digits of the 12NC ordering code.<sup>[1]</sup>

Type number	Package	Description	Packing quantity	
			3000	10000
BZX100A	SOD323F	4 mm pitch, 8 mm tape and reel	-115	-135

[1] For further information and the availability of packing methods, see [Section 15](#).

**12. Soldering**

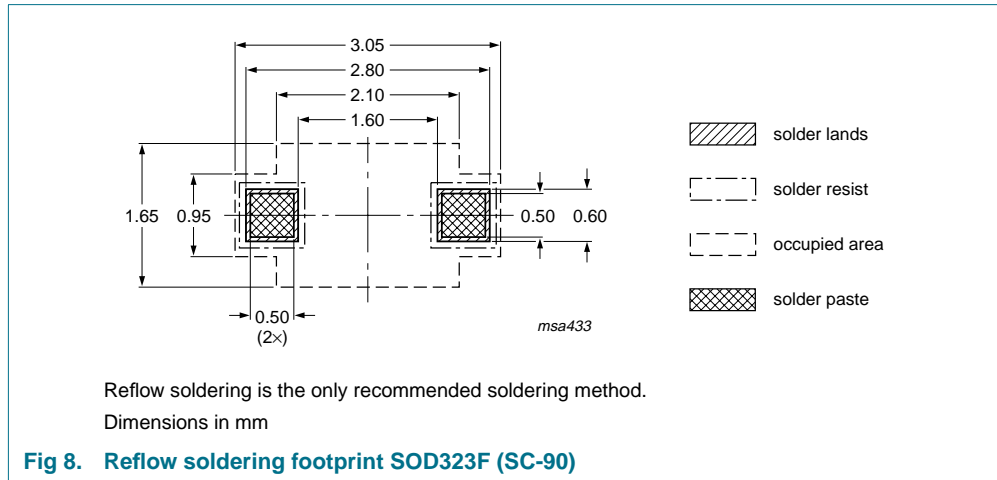

### 13. Revision history

**Table 9.** Revision history

Document ID	Release date	Data sheet status	Change notice	Supersedes
BZX100A_1	20070530	Product data sheet	-	-



## 14. Legal information

### 14.1 Data sheet status

Document status <sup>[1][2]</sup>	Product status <sup>[3]</sup>	Definition
Objective [short] data sheet	Development	This document contains data from the objective specification for product development.
Preliminary [short] data sheet	Qualification	This document contains data from the preliminary specification.
Product [short] data sheet	Production	This document contains the product specification.

[1] Please consult the most recently issued document before initiating or completing a design.

[2] The term 'short data sheet' is explained in section "Definitions".

[3] The product status of device(s) described in this document may have changed since this document was published and may differ in case of multiple devices. The latest product status information is available on the Internet at URL <http://www.nxp.com>.

### 14.2 Definitions

**Draft** — The document is a draft version only. The content is still under internal review and subject to formal approval, which may result in modifications or additions. NXP Semiconductors does not give any representations or warranties as to the accuracy or completeness of information included herein and shall have no liability for the consequences of use of such information.

**Short data sheet** — A short data sheet is an extract from a full data sheet with the same product type number(s) and title. A short data sheet is intended for quick reference only and should not be relied upon to contain detailed and full information. For detailed and full information see the relevant full data sheet, which is available on request via the local NXP Semiconductors sales office. In case of any inconsistency or conflict with the short data sheet, the full data sheet shall prevail.

### 14.3 Disclaimers

**General** — Information in this document is believed to be accurate and reliable. However, NXP Semiconductors does not give any representations or warranties, expressed or implied, as to the accuracy or completeness of such information and shall have no liability for the consequences of use of such information.

**Right to make changes** — NXP Semiconductors reserves the right to make changes to information published in this document, including without limitation specifications and product descriptions, at any time and without notice. This document supersedes and replaces all information supplied prior to the publication hereof.

**Suitability for use** — NXP Semiconductors products are not designed, authorized or warranted to be suitable for use in medical, military, aircraft, space or life support equipment, nor in applications where failure or

malfunction of a NXP Semiconductors product can reasonably be expected to result in personal injury, death or severe property or environmental damage. NXP Semiconductors accepts no liability for inclusion and/or use of NXP Semiconductors products in such equipment or applications and therefore such inclusion and/or use is at the customer's own risk.

**Applications** — Applications that are described herein for any of these products are for illustrative purposes only. NXP Semiconductors makes no representation or warranty that such applications will be suitable for the specified use without further testing or modification.

**Limiting values** — Stress above one or more limiting values (as defined in the Absolute Maximum Ratings System of IEC 60134) may cause permanent damage to the device. Limiting values are stress ratings only and operation of the device at these or any other conditions above those given in the Characteristics sections of this document is not implied. Exposure to limiting values for extended periods may affect device reliability.

**Terms and conditions of sale** — NXP Semiconductors products are sold subject to the general terms and conditions of commercial sale, as published at <http://www.nxp.com/profile/terms>, including those pertaining to warranty, intellectual property rights infringement and limitation of liability, unless explicitly otherwise agreed to in writing by NXP Semiconductors. In case of any inconsistency or conflict between information in this document and such terms and conditions, the latter will prevail.

**No offer to sell or license** — Nothing in this document may be interpreted or construed as an offer to sell products that is open for acceptance or the grant, conveyance or implication of any license under any copyrights, patents or other industrial or intellectual property rights.

### 14.4 Trademarks

Notice: All referenced brands, product names, service names and trademarks are the property of their respective owners.

## 15. Contact information

For additional information, please visit: <http://www.nxp.com>

For sales office addresses, send an email to: [salesaddresses@nxp.com](mailto:salesaddresses@nxp.com)

## 16. Contents

<b>1</b>	<b>Product profile</b> . . . . .	<b>1</b>
1.1	General description. . . . .	1
1.2	Features . . . . .	1
1.3	Applications . . . . .	1
1.4	Quick reference data. . . . .	1
<b>2</b>	<b>Pinning information</b> . . . . .	<b>1</b>
<b>3</b>	<b>Ordering information</b> . . . . .	<b>2</b>
<b>4</b>	<b>Marking</b> . . . . .	<b>2</b>
<b>5</b>	<b>Limiting values</b> . . . . .	<b>2</b>
<b>6</b>	<b>Thermal characteristics</b> . . . . .	<b>3</b>
<b>7</b>	<b>Characteristics</b> . . . . .	<b>4</b>
<b>8</b>	<b>Application information</b> . . . . .	<b>5</b>
<b>9</b>	<b>Test information</b> . . . . .	<b>6</b>
9.1	Quality information . . . . .	6
<b>10</b>	<b>Package outline</b> . . . . .	<b>6</b>
<b>11</b>	<b>Packing information</b> . . . . .	<b>6</b>
<b>12</b>	<b>Soldering</b> . . . . .	<b>7</b>
<b>13</b>	<b>Revision history</b> . . . . .	<b>8</b>
<b>14</b>	<b>Legal information</b> . . . . .	<b>9</b>
14.1	Data sheet status . . . . .	9
14.2	Definitions . . . . .	9
14.3	Disclaimers . . . . .	9
14.4	Trademarks . . . . .	9
<b>15</b>	<b>Contact information</b> . . . . .	<b>9</b>
<b>16</b>	<b>Contents</b> . . . . .	<b>10</b>



Please be aware that important notices concerning this document and the product(s) described herein, have been included in section 'Legal information'.

© NXP B.V. 2007.

All rights reserved.

For more information, please visit: <http://www.nxp.com>

For sales office addresses, please send an email to: [salesaddresses@nxp.com](mailto:salesaddresses@nxp.com)

Date of release: 30 May 2007

Document identifier: BZX100A\_1