

DMP1245UFCL

12V P-CHANNEL ENHANCEMENT MODE MOSFET

Summary

| V _{(BR)DSS} | R _{DS(on)} max | I _D max |
|----------------------|--------------------------------|--------------------|
| -12V | 29mΩ @V _{GS} = -4.5V | -6.6 A |
| | 45mΩ @V _{GS} = -2.5V | -5.3 A |
| | 60mΩ @V _{GS} = -1.8V | -4.6 A |
| | 100mΩ @V _{GS} = -1.5V | -3.5 A |

Application

This device provides a high performance, low R_{DS(ON)} P channel MOSFETs in the thermally and space efficient X1-DFN1616-6 package. The low R_{DS(ON)} of this MOSFET ensures conduction losses are kept making it ideal for use as a:

- Battery disconnect switch
- Load switch for power management functions

Features and Benefits

- Typical off board profile of 0.5mm - ideally suited for thin applications
- Low R_{DS(ON)} – minimizes conduction losses
- PCB footprint of 2.56mm²
- **3kV ESD Protected Gate** – protected against human borne ESD
- "Lead-Free", RoHS Compliant (Note 1)
- "Green" Device (Note 2)

Mechanical Data

- Case: X1-DFN1616-6 Type E
- Case Material: Molded Plastic, "Green" Molding Compound. UL Flammability Classification Rating 94V-0
- Moisture Sensitivity: Level 1 per J-STD-020
- Lead Free Plating (NiPdAu Finish over Copper leadframe).
- Terminals: Solderable per MIL-STD-202, Method 208
- Weight: 0.04 grams (approximate)

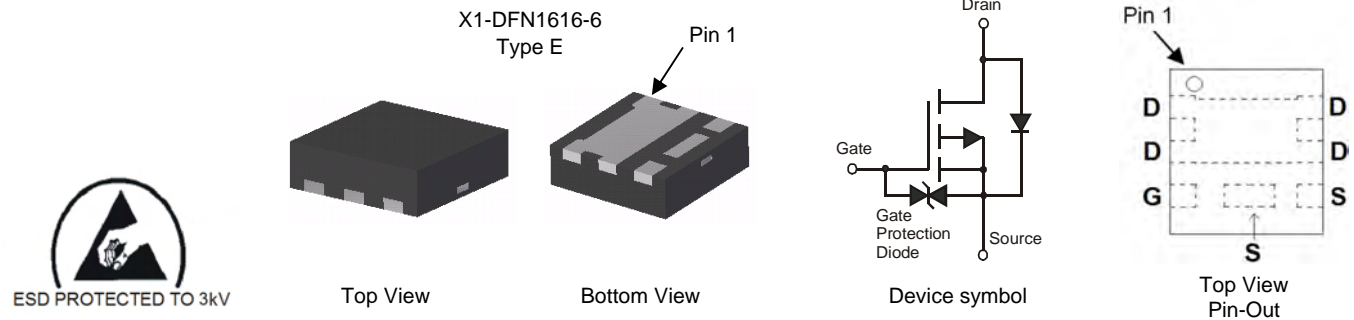

Ordering Information (Note 3)

| Product | Marking | Reel size (inches) | Tape width (mm) | Quantity per reel |
|---------------|---------|--------------------|-----------------|-------------------|
| DMP1245UFCL-7 | P5 | 7 | 8 | 3,000 |

- Notes:
1. No purposefully added lead.
 2. Diodes Inc's "Green" Policy can be found on our website at <http://www.diodes.com>
 3. For packaging details, go to our website at <http://www.diodes.com>

Marking Information

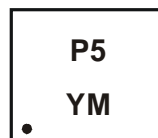

P5 = Product Type Marking Code
 YM = Date Code Marking
 Y = Year (ex: X = 2010)
 M = Month (ex: 9 = September)

Date Code Key

| Year | 2011 | 2012 | 2013 | 2014 | 2015 | 2016 | 2017 |
|------|------|------|------|------|------|------|------|
| Code | Y | Z | A | B | C | D | E |

| Month | Jan | Feb | Mar | Apr | May | Jun | Jul | Aug | Sep | Oct | Nov | Dec |
|-------|-----|-----|-----|-----|-----|-----|-----|-----|-----|-----|-----|-----|
| Code | 1 | 2 | 3 | 4 | 5 | 6 | 7 | 8 | 9 | O | N | D |

Maximum Ratings @T_A = 25°C unless otherwise specified

| Characteristic | Symbol | Value | Units |
|-----------------------------------|------------------|--|-------|
| Drain-Source Voltage | V _{DSS} | -12 | V |
| Gate-Source Voltage | V _{GSS} | ±8 | V |
| Continuous Drain Current (Note 5) | I _D | -6.6 -5.25 | A |
| | | @ T _A = 25°C @ T _A = 70°C | |
| Pulsed Drain Current | I _{DM} | -16.67 | A |
| | | T _P = 10µs | |

Thermal Characteristics @T_A = 25°C unless otherwise specified

| Characteristic | Symbol | Value | Units |
|---|-----------------------------------|-------------|-------|
| Total Power Dissipation | P _D | 613 | mW |
| | | 1.7 | W |
| Thermal Resistance, Junction to Ambient | R _{θJA} | 204 | °C/W |
| | | 74 | |
| Operating and Storage Temperature Range | T _J , T _{STG} | -55 to +150 | °C |

- Notes:
4. For a device surface mounted on minimum recommended pad layout, in still air conditions; the device is measured when operating in a steady state condition.
 5. For a device surface mounted on 25mm by 25mm by 1.6mm FR4 PCB with high coverage of single sided 2oz copper, in still air conditions; the device is measured when operating in a steady state condition.

Thermal Characteristics

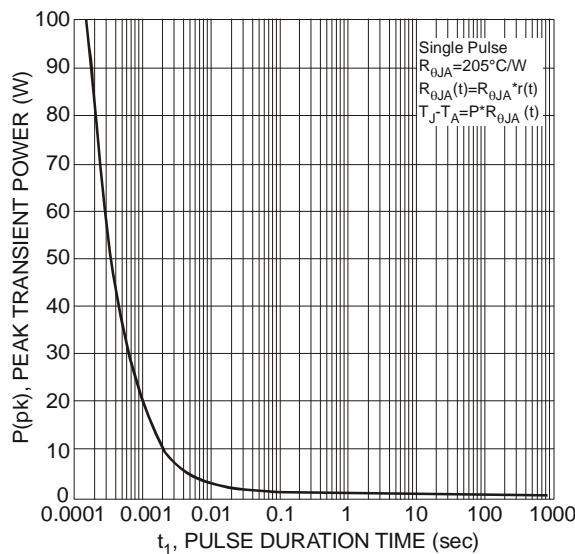

Fig. 1 Single Pulse Maximum Power Dissipation

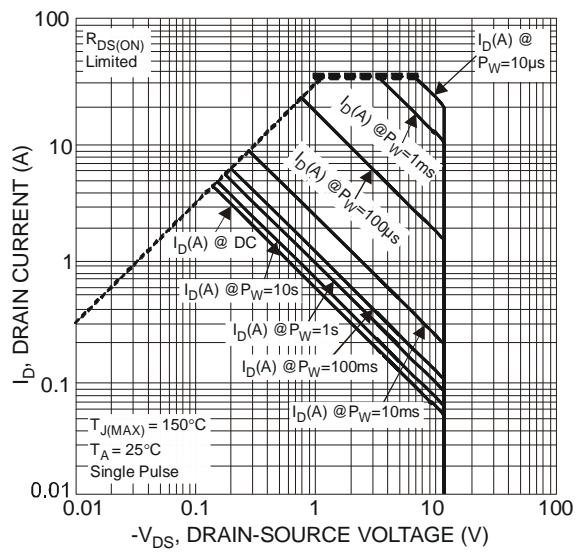
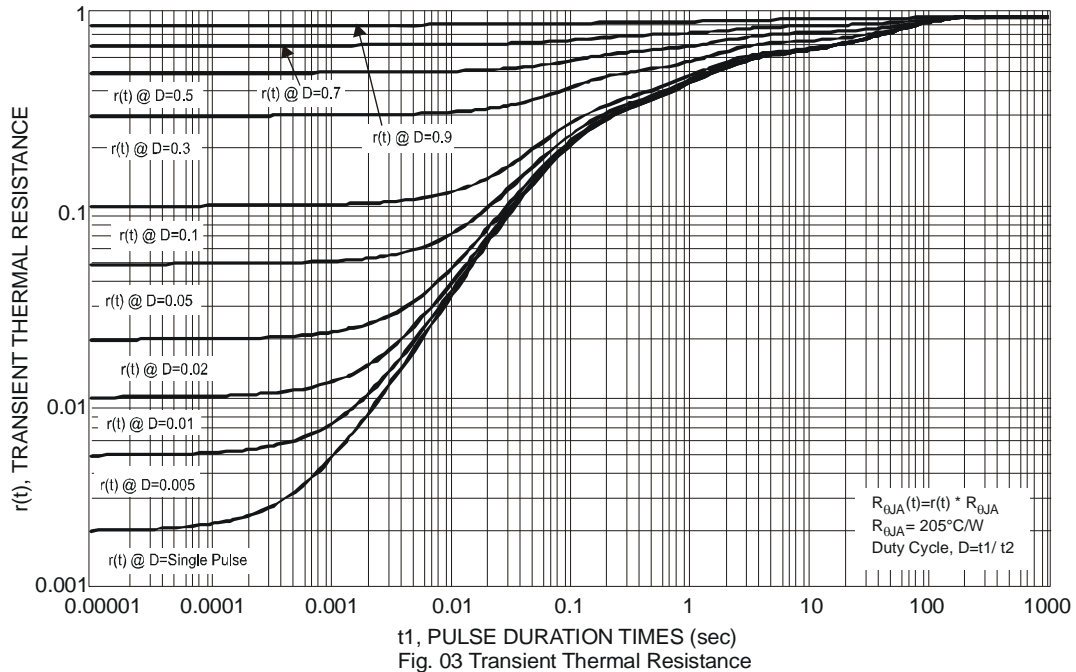

Fig. 2 SOA, Safe Operation Area



Electrical Characteristics @T_A = 25°C unless otherwise specified

| Characteristic | Symbol | Min | Typ | Max | Unit | Test Condition |
|---|----------------------|------|--------|-------|------|--|
| OFF CHARACTERISTICS (Note 6) | | | | | | |
| Drain-Source Breakdown Voltage | BV _{DSS} | -12 | — | — | V | V _{GS} = 0V, I _D = -250μA |
| Zero Gate Voltage Drain Current T _J = 25°C | I _{DSS} | — | — | -1 | μA | V _{DS} = -12.0V, V _{GS} = 0V |
| Gate-Source Leakage | I _{GSS} | — | — | ±10 | μA | V _{GS} = ±8.0V, V _{DS} = 0V |
| ON CHARACTERISTICS (Note 6) | | | | | | |
| Gate Threshold Voltage | V _{GS(th)} | -0.3 | -0.6 | -0.95 | V | V _{DS} = V _{GS} , I _D = -250μA |
| Static Drain-Source On-Resistance | R _{DS (ON)} | — | 25 | 29 | mΩ | V _{GS} = -4.5V, I _D = -4A |
| | | — | 31 | 45 | | V _{GS} = -2.5V, I _D = -3.5A |
| | | — | 40 | 60 | | V _{GS} = -1.8V, I _D = -1A |
| | | — | 60 | 100 | | V _{GS} = -1.5V, I _D = -0.5A |
| Forward Transfer Admittance | Y _{fs} | 0.4 | 3 | - | S | V _{DS} = -5V, I _D = -2A |
| Diode Forward Voltage | V _{SD} | - | - | -1.0 | V | V _{GS} = 0V, I _D = -2A |
| DYNAMIC CHARACTERISTICS (Note 7) | | | | | | |
| Input Capacitance | C _{iSS} | - | 1357.4 | - | pF | V _{DS} = -10V, V _{GS} = 0V f = 1.0MHz |
| Output Capacitance | C _{oSS} | - | 499 | - | pF | |
| Reverse Transfer Capacitance | C _{rSS} | - | 273.6 | - | pF | |
| Gate Resistance | R _g | - | 14.26 | - | Ω | V _{DS} = 0V, V _{GS} = 0V, f = 1MHz |
| Total Gate Charge | Q _g | - | 16.1 | - | nC | V _{GS} = -4.5V I _D = -1A, V _{DS} = -10V |
| Gate-Source Charge | Q _{gs} | - | 26.1 | - | nC | |
| Gate-Drain Charge | Q _{gd} | - | 1.71 | - | nC | |
| Turn-On Delay Time | t _{D(on)} | - | 20.48 | - | ns | V _{GS} = -2.5V, V _{DS} = -10V I _D = -180mA, R _G = 2.0Ω, |
| Turn-On Rise Time | t _r | - | 15.2 | - | ns | |
| Turn-Off Delay Time | t _{D(off)} | - | 33.11 | - | ns | |
| Turn-Off Fall Time | t _f | - | 219.4 | - | ns | |
| Turn-Off Fall Time | t _f | - | 217.64 | - | ns | |

Notes: 6. Short duration pulse test used to minimize self-heating effect.
7. Guaranteed by design. Not subject to production testing.

DMP1245UFCL

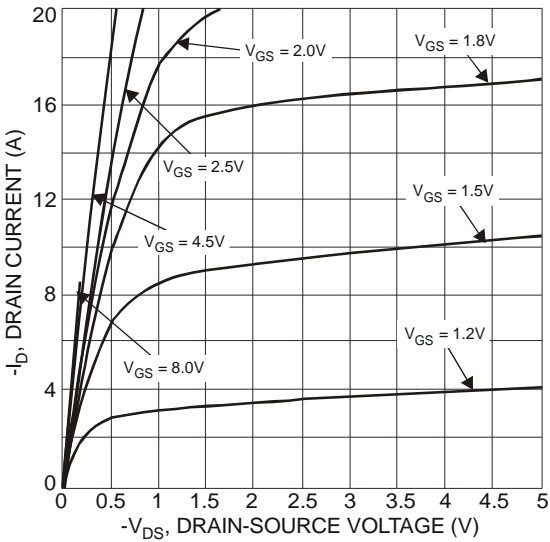

Fig. 4 Typical Output Characteristics

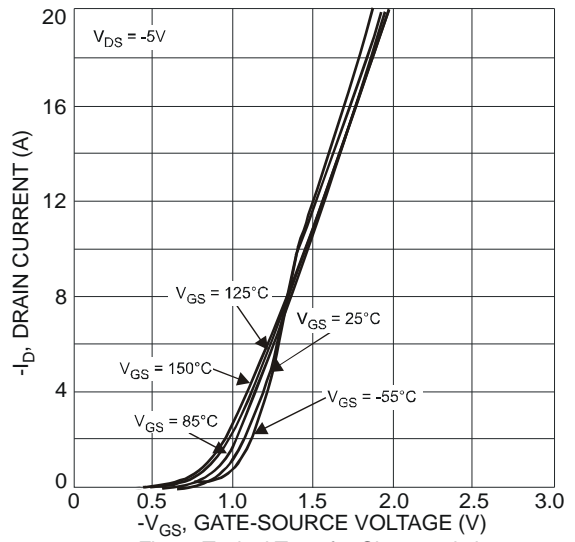

Fig. 5 Typical Transfer Characteristic

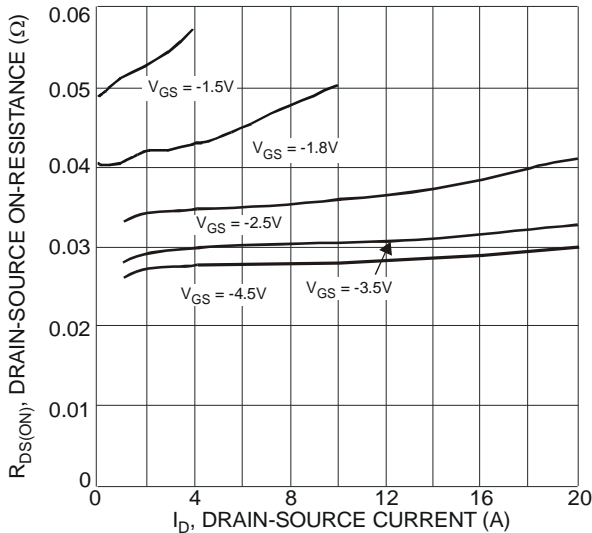

Fig. 6 Typical On-Resistance vs. Drain Current and Gate Voltage

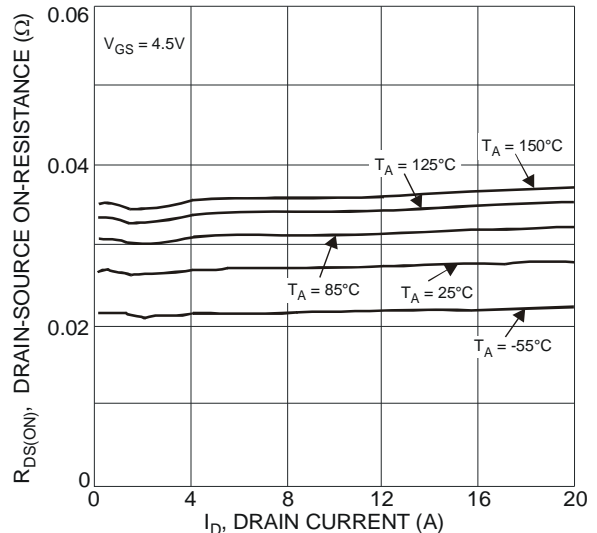

Fig. 7 Typical On-Resistance vs. Drain Current and Temperature

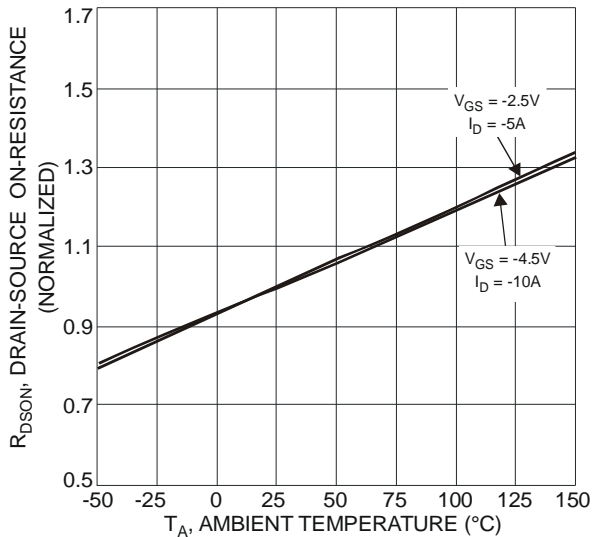

Fig. 8 On-Resistance Variation with Temperature

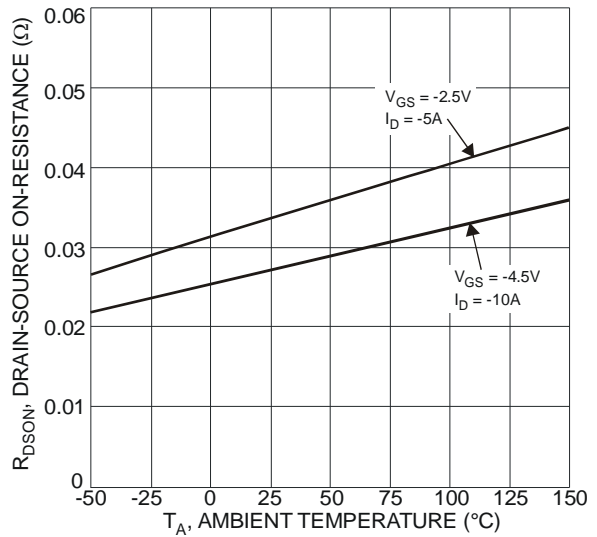

Fig. 9 On-Resistance Variation with Temperature

DMP1245UFCL

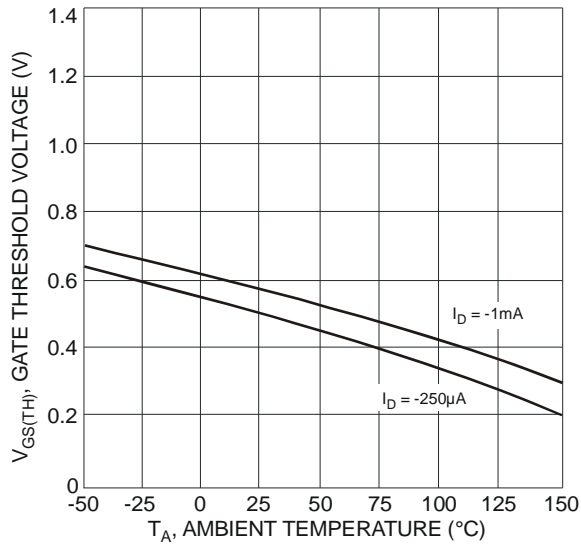

Fig. 10 Gate Threshold Variation vs. Ambient Temperature

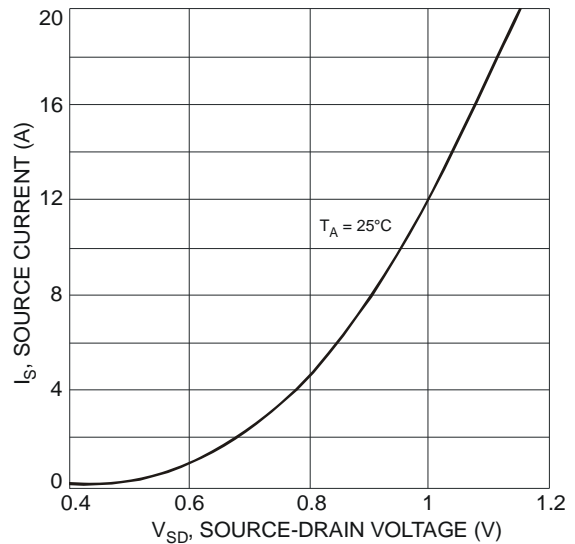

Fig. 11 Diode Forward Voltage vs. Current

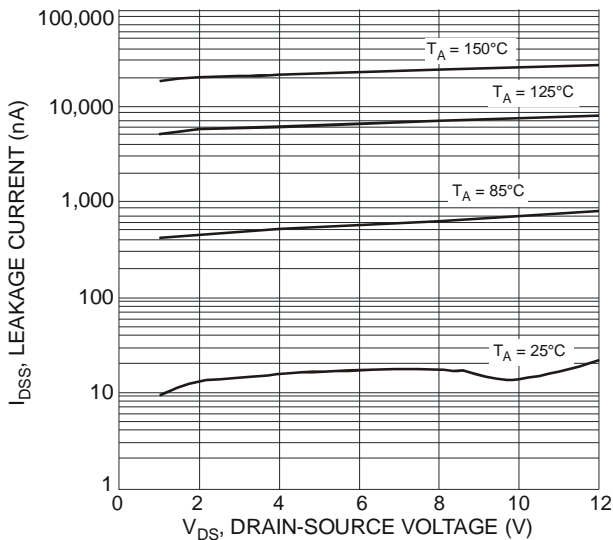

Fig. 12 Typical Drain-Source Leakage Current vs. Voltage

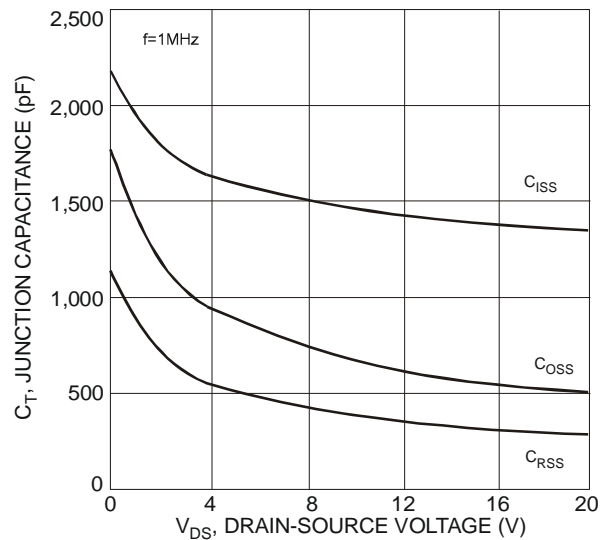

Fig. 13 Typical Junction Capacitance

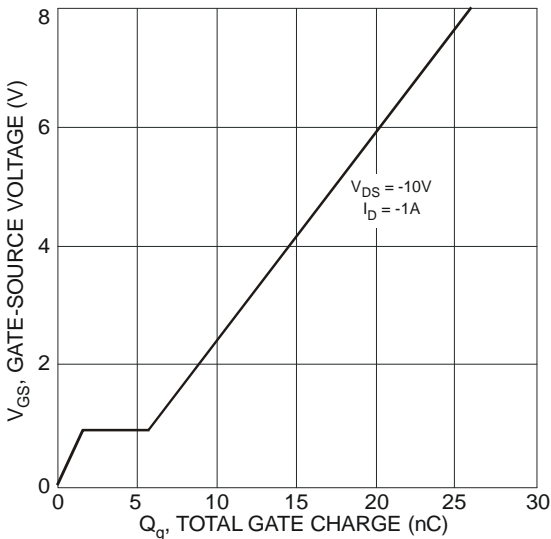
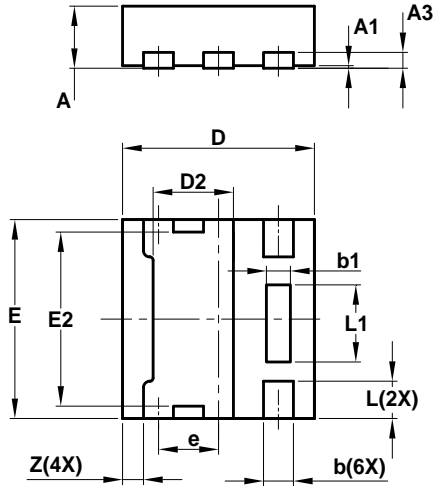

Fig. 14 Gate-Charge Characteristics

Package Outline Dimensions



| X1-DFN1616-6 Type E | | | |
|------------------------|------|------|-------|
| Dim | Min | Max | Typ |
| A | 0.47 | 0.53 | 0.50 |
| A1 | 0 | 0.05 | 0.02 |
| A3 | — | — | 0.13 |
| b | 0.20 | 0.30 | 0.25 |
| b1 | 0.10 | 0.30 | 0.20 |
| D | 1.55 | 1.65 | 1.60 |
| D2 | 0.57 | 0.77 | 0.67 |
| E | 1.55 | 1.65 | 1.60 |
| E2 | 1.30 | 1.50 | 1.40 |
| e | — | — | 0.50 |
| L | 0.25 | 0.35 | 0.30 |
| L1 | 0.52 | 0.72 | 0.62 |
| Z | — | — | 0.175 |
| All Dimensions in mm | | | |

Suggested Pad Layout

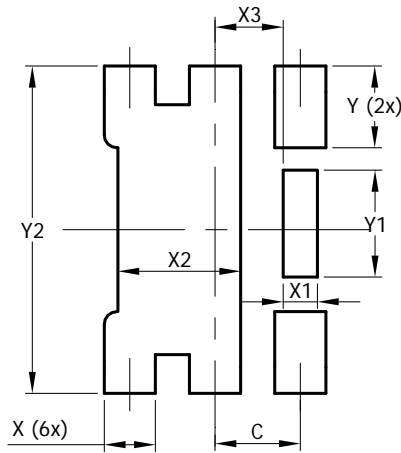

| Dimensions | Value (in mm) |
|------------|---------------|
| C | 0.500 |
| X | 0.300 |
| X1 | 0.200 |
| X2 | 0.720 |
| X3 | 0.400 |
| Y | 0.475 |
| Y1 | 0.620 |
| Y2 | 1.900 |

IMPORTANT NOTICE

DIODES INCORPORATED MAKES NO WARRANTY OF ANY KIND, EXPRESS OR IMPLIED, WITH REGARDS TO THIS DOCUMENT, INCLUDING, BUT NOT LIMITED TO, THE IMPLIED WARRANTIES OF MERCHANTABILITY AND FITNESS FOR A PARTICULAR PURPOSE (AND THEIR EQUIVALENTS UNDER THE LAWS OF ANY JURISDICTION).

Diodes Incorporated and its subsidiaries reserve the right to make modifications, enhancements, improvements, corrections or other changes without further notice to this document and any product described herein. Diodes Incorporated does not assume any liability arising out of the application or use of this document or any product described herein; neither does Diodes Incorporated convey any license under its patent or trademark rights, nor the rights of others. Any Customer or user of this document or products described herein in such applications shall assume all risks of such use and will agree to hold Diodes Incorporated and all the companies whose products are represented on Diodes Incorporated website, harmless against all damages.

Diodes Incorporated does not warrant or accept any liability whatsoever in respect of any products purchased through unauthorized sales channel. Should Customers purchase or use Diodes Incorporated products for any unintended or unauthorized application, Customers shall indemnify and hold Diodes Incorporated and its representatives harmless against all claims, damages, expenses, and attorney fees arising out of, directly or indirectly, any claim of personal injury or death associated with such unintended or unauthorized application.

Products described herein may be covered by one or more United States, international or foreign patents pending. Product names and markings noted herein may also be covered by one or more United States, international or foreign trademarks.

LIFE SUPPORT

Diodes Incorporated products are specifically not authorized for use as critical components in life support devices or systems without the express written approval of the Chief Executive Officer of Diodes Incorporated. As used herein:

A. Life support devices or systems are devices or systems which:

1. are intended to implant into the body, or
2. support or sustain life and whose failure to perform when properly used in accordance with instructions for use provided in the labeling can be reasonably expected to result in significant injury to the user.

B. A critical component is any component in a life support device or system whose failure to perform can be reasonably expected to cause the failure of the life support device or to affect its safety or effectiveness.

Customers represent that they have all necessary expertise in the safety and regulatory ramifications of their life support devices or systems, and acknowledge and agree that they are solely responsible for all legal, regulatory and safety-related requirements concerning their products and any use of Diodes Incorporated products in such safety-critical, life support devices or systems, notwithstanding any devices- or systems-related information or support that may be provided by Diodes Incorporated. Further, Customers must fully indemnify Diodes Incorporated and its representatives against any damages arising out of the use of Diodes Incorporated products in such safety-critical, life support devices or systems.

Copyright © 2011, Diodes Incorporated

www.diodes.com