

VOLTAGE DETECTOR

■ GENERAL DESCRIPTION

The **NJM2078** is a dual comparator including precise reference circuit. Output stages are open collector and can be used on wired OR. The NJM2078 has hysteresis terminals.

As it is less operating current, the **NJM2078** is suitable for voltage detection of decreased power supply in memory stack and abnormal voltage.

■ PACKAGE OUTLINE

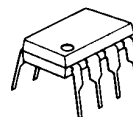

NJM2078D



NJM2078M

■ FEATURES

- Low Operating Current (250 μ A typ.)
- Stabled Internal Reference Voltage (1.20V typ.)
- Hysteresis Function with Resistors
- Package Outline DIP8, DMP8
- Bipolar Technology

■ PIN CONFIGURATION

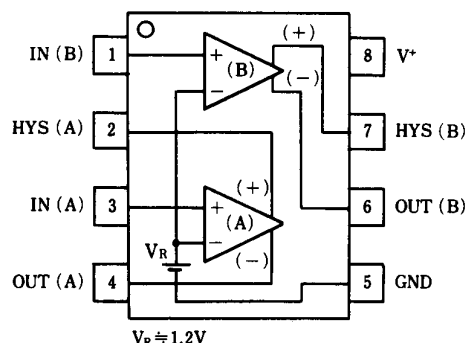

NJM2078D
NJM2078M

■ EQUIVALENT CIRCUIT

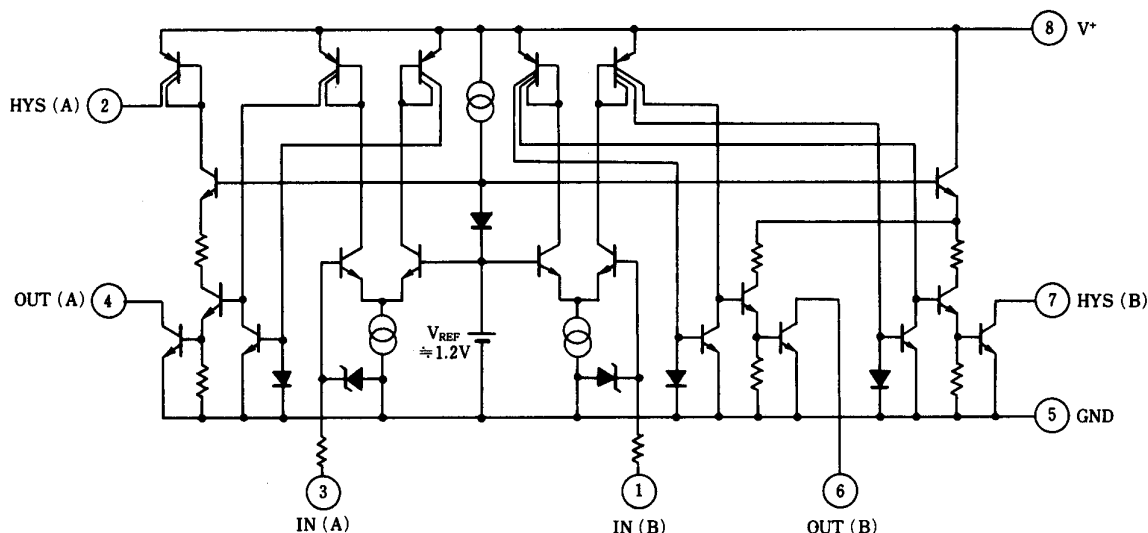

NJM2078

■ ABSOLUTE MAXIMUM RATINGS

($T_a=25^\circ\text{C}$)

PARAMETER	SYMBOL	RATINGS	UNIT
Supply Voltage	V^*	21	V
Output Voltage	V_O	21	V
Output Current	I_O	50	mA
Input Voltage	V_{IN}	-0.3 to +6.5	Vdc
Power Dissipation	P_D	(DIP8) 500	mW
		(DMP8) 300	mW
Operating Temperature Range	T_{opr}	-40 to +85	$^\circ\text{C}$
Storage Temperature Range	T_{stg}	-40 to +125	$^\circ\text{C}$

■ ELECTRICAL CHARACTERISTICS

($V^+=5V, T_a=25^\circ C$)

PARAMETER	SYMBOL	CONDITION	MIN.	TYP.	MAX.	UNIT
Operating Current	I_{OCL}	$V^+=20V, V_{IL}=1.0V$	-	250	400	μA
	I_{OCH}	$V^+=20V, V_{IH}=1.5V$	-	400	600	μA
Threshold Voltage	V_{TH}	$I_O=2mA, V_O=1V$	1.15	1.20	1.25	V
Threshold Voltage Deviation vs. Operating Voltage	ΔV_{TH1}	$2.5V \leq V^+ \leq 5.5V$	-	3	12	mV
	ΔV_{TH2}	$4.5V \leq V^+ \leq 20V$	-	10	40	mV
Offset Voltage Between Normal Output and Hysteresis Output		$I_O(A)=4.5mA, V_O(A)=2V, I_H(A)=20\mu A, V_H(A)=3V$	-	2.0	-	mV
		$I_O(B)=3mA, V_O(B)=2V, I_H(B)=3mA, V_H(B)=2V$	-	2.0	-	mV
Threshold Voltage Temperature Coefficient		$-20^\circ C \leq T_a \leq 70^\circ C$	-	± 0.05	-	mV / $^\circ C$
Threshold Voltage Difference Between Channels			-10	-	10	mV
Input Current	I_{IL}	$V_{IL}=1.0V$	-	5	-	nA
	I_{IH}	$V_{IH}=1.5V$	-	100	500	nA
Output Leak Current	I_{OH}	$V_O=20V, V_{IL}=1.0V$	-	-	1	μA
Hysteresis Output Leak Current	$I_{HL}(A)$	$V^+=20V, V_H(A)=0V, V_{IL}=1.0V$	-	-	0.1	μA
	$I_{HH}(B)$	$V_H(B)=20V, V_{IH}=1.5V$	-	-	1	μA
Output Sink Current	$I_{OL}(A)$	$V_O=1.0V, V_{IH}=1.5V$	6	12	-	mA
	$I_{OL}(B)$	$V_O=1.0V, V_{IH}=1.5V$	4	10	-	mA
Hysteresis Current	$I_{HH}(A)$	$V_H=0V, V_{IH}=1.5V$	40	80	-	μA
	$I_{HL}(B)$	$V_H=1.0V, V_{IL}=1.0V$	4	10	-	mA
Output Saturation Voltage	$V_{OL}(A)$	$I_O=4.5mA, V_{IH}=1.5V$	-	120	400	mV
	$V_{OL}(B)$	$I_O=3.0mA, V_{IH}=1.5V$	-	120	400	mV
Hysteresis Output Saturation Voltage	$V_{HH}(A)$	$I_H=20\mu A, V_{IH}=1.5V$	-	50	200	mV
	$V_{HL}(B)$	$I_H=3.0mA, V_{IL}=1.0V$	-	120	400	mV
Delay Time	t_{PHL}	$R_L=5k\Omega$	-	2	-	μs
	t_{PLH}	$R_L=5k\Omega$	-	3	-	μs

■ OPERATION PRINCIPLE

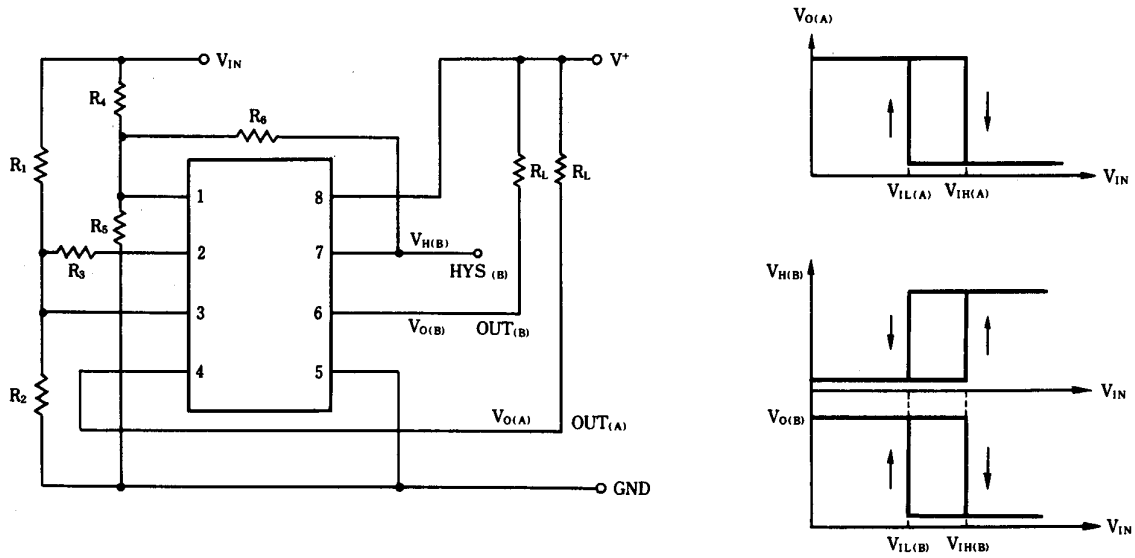

Equation

$$V_{IH(A)} = \left(1 + \frac{R_1}{R_2}\right) V_R$$

$$V_{IL(A)} = \left(1 + \frac{R_1}{R_2 // R_3}\right) V_R - \frac{R_1}{R_3} V^+$$

$$V_{IH(B)} = \left(1 + \frac{R_4}{R_5 // R_6}\right) V_R$$

$$V_{IL(B)} = \left(1 + \frac{R_4}{R_5}\right) V_R$$

(note) $V_R \doteq V_H (\doteq 1.20V)$

$$R_2 // R_3 = \frac{R_2 R_3}{R_2 + R_3}$$

$$R_5 // R_6 = \frac{R_5 R_6}{R_5 + R_6}$$

■ TYPICAL APPLICATION

1. Hysterisis

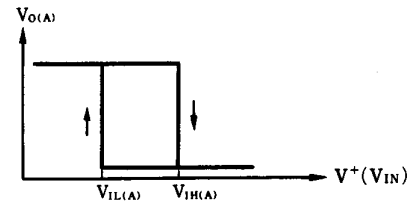
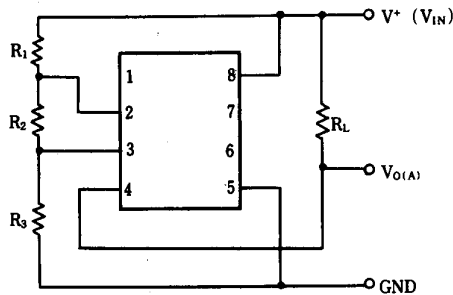

$$V_{IN(A)} \doteq \left(1 + \frac{R_1 + R_2}{R_3}\right) V_R$$

$$V_{IL(A)} \doteq \left(1 + \frac{R_2}{R_3}\right) V_R$$

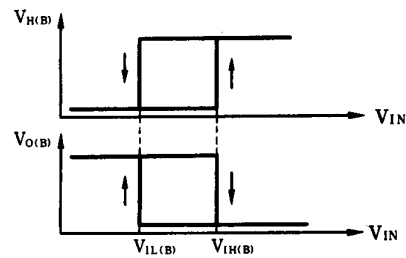
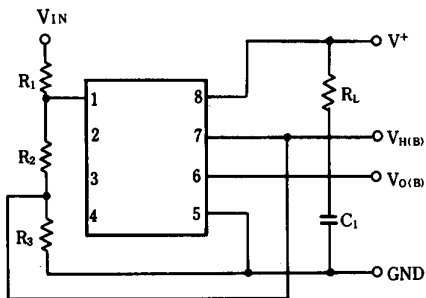

$$V_{IN(B)} \doteq \left(1 + \frac{R_1}{R_2}\right) V_R$$

$$V_{IL(B)} \doteq \left(1 + \frac{R_1}{R_2 + R_3}\right) V_R$$

Each equation is calculated without considering the saturation voltage. It is necessary to compensate by the saturation voltage fit to lead conditions, precisely.

2. Detection of Abnormal Supply Voltage

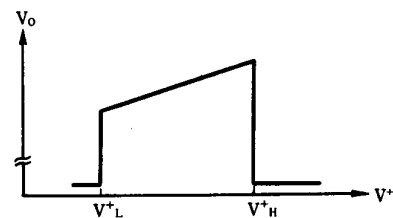
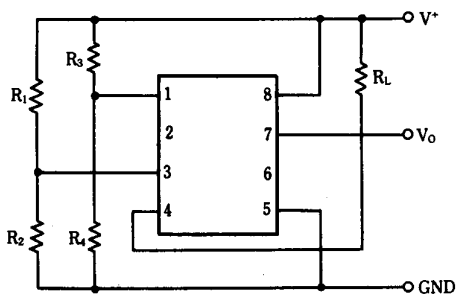

$$V^+_H = \left(1 + \frac{R_1}{R_2}\right) V_R$$

$$V^+_L = \left(1 + \frac{R_3}{R_4}\right) V_R$$

Note : $V^+ \geq 2.5V$

Hysteresis ; Positive feedback from pin 2 or pin 7 (ref.1).

3. Detection of Abnormal Operating Voltage

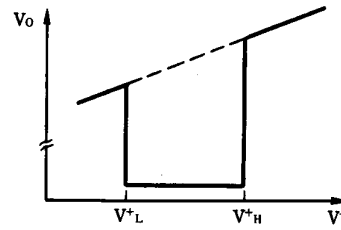
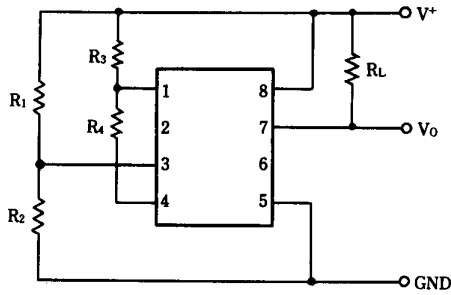

$$V^+_{H} = \left(1 + \frac{R_3}{R_4}\right) V_R$$

$$V^+_{L} = \left(1 + \frac{R_1}{R_2}\right) V_R$$

Note : $V^+_{L} \geq 2.5V$

4. Programmable Zener

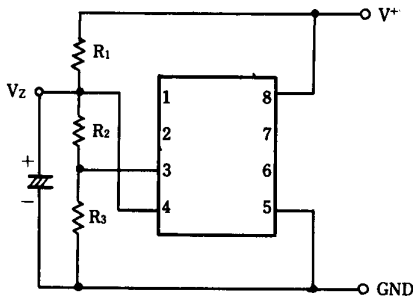

$$V_Z = \left(1 + \frac{R_2}{R_3}\right) V_R$$

$$\frac{V_Z}{R_2 + R_3} \leq V \frac{V^+ - V_Z}{R_1} \leq 6mA$$

Can use channel B independently.

5. Reset Circuit for Decreased Operating Voltage

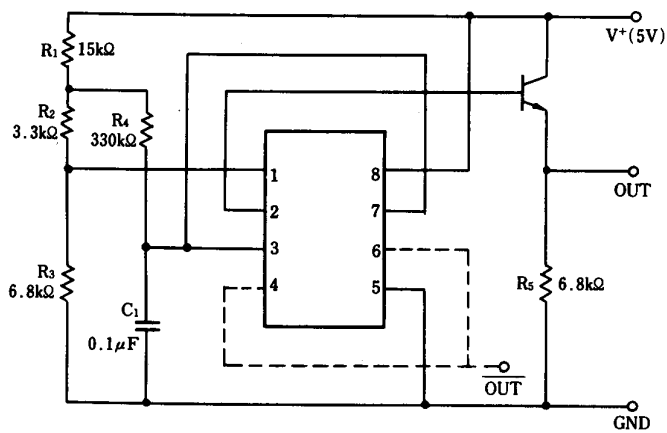

Compare Voltage and hysteresis width can be adjustable by R_1 to R_4 . Roughly,

$$V^{+(L)} = \frac{R_1 + R_2 + R_3}{R_3} V_{TH}$$

$$V^{+(H)} = V^{+(L)} \frac{R_1(R_2 + R_3)}{R_3 R_4} V_{TH}$$

- Power-on reset time t_{RST} (roughly)

$$t_{RST} = -C_1 R_4 \ln \left\{ 1 - \frac{V_{TH}}{V^+} \left(1 + \frac{R_1}{R_2 + R_3} \right) \right\}$$

- Transistor ; Recommended $h_{FE} = 50$ to 200
- Rapid Signal Off ; Be care to remained charge of C_1 . It affects to t_{RST}
- Reverse polarity output \overline{OUT} : Open collector.

■ TYPICAL CHARACTERISTICS

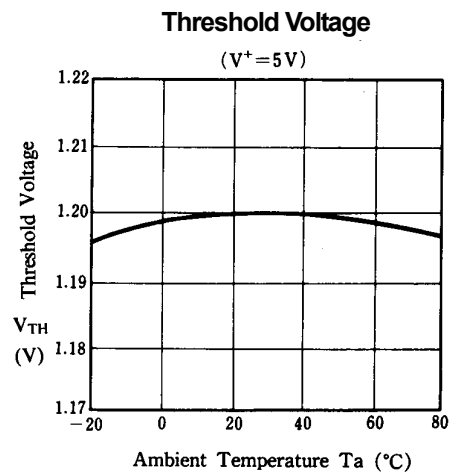
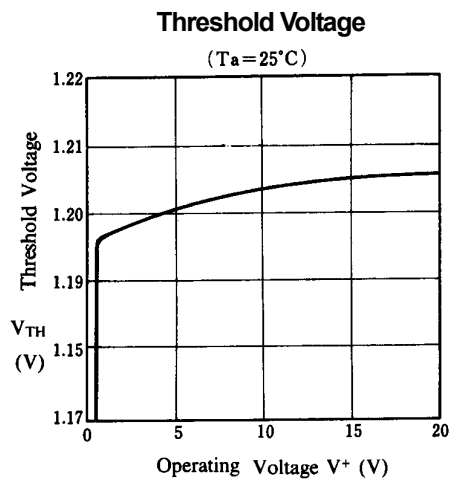
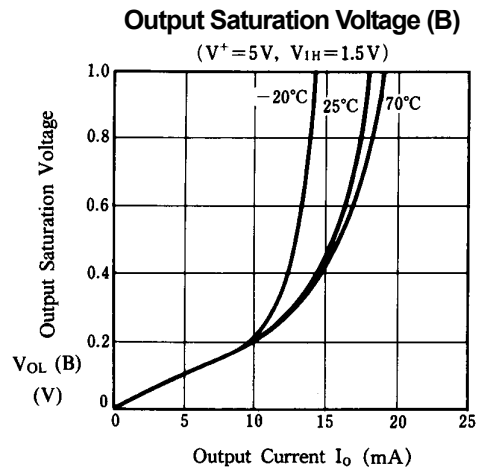
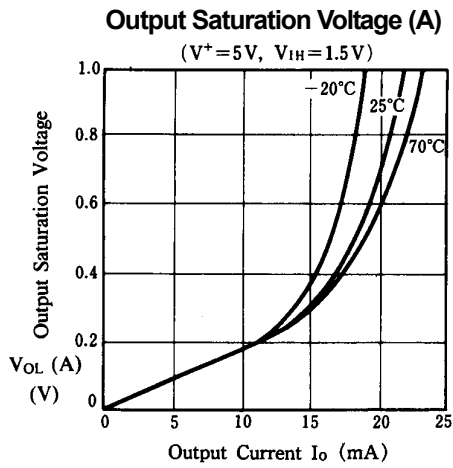
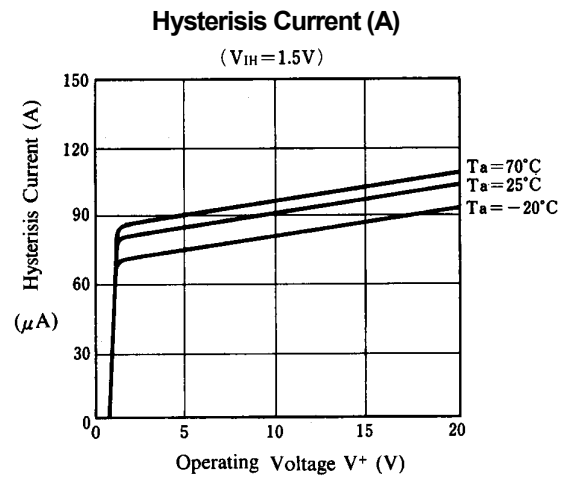
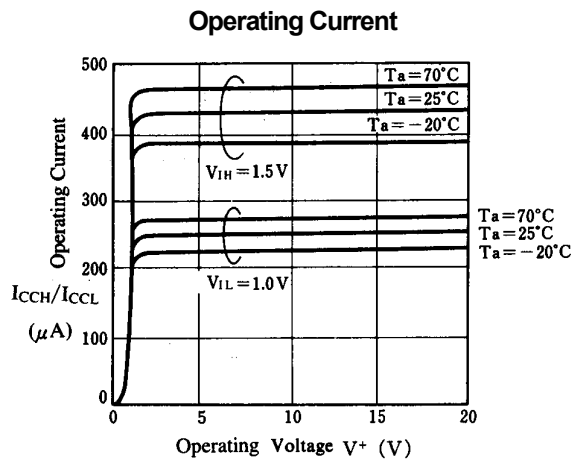

NJM2078

■ TYPICAL CHARACTERISTICS (Refer to Application 5 of Reset Circuit for Decreased Supply Voltage)

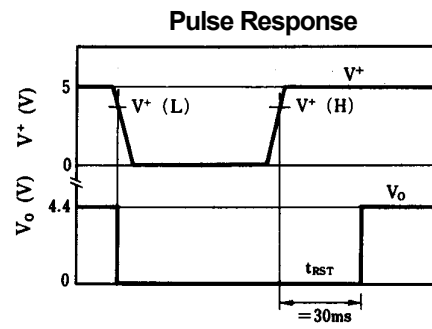
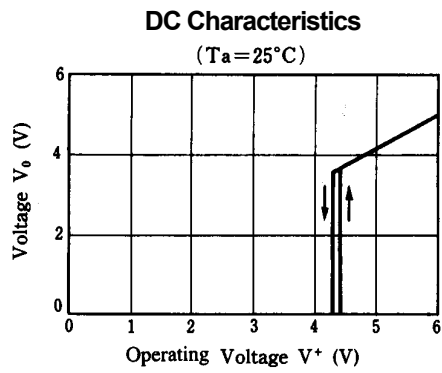

[CAUTION]

The specifications on this databook are only given for information, without any guarantee as regards either mistakes or omissions. The application circuits in this databook are described only to show representative usages of the product and not intended for the guarantee or permission of any right including the industrial rights.