

Features

- 30 ps Ultra-low cycle-to-cycle jitter
- Frequency range
 - 1 MHz to 200 MHz
- Center Spread Modulation: $\pm 0.25\%$, $\pm 0.5\%$, $\pm 1\%$
- Down Spread Modulation: -0.5% , -1% , -2%
 - Spread Disable Option available
- Power down or Output Enable option available
- Frequency stability
 - ± 50 ppm or ± 100 ppm (Spread = OFF)
- Operating voltage
 - 1.8V or 2.5 or 3.3 V
 - Other voltages up to 3.63 V (contact SiTime)
- Operating Temperature Range
 - Industrial, -40°C to $+85^{\circ}\text{C}$
 - Extended Commercial, -20°C to $+70^{\circ}\text{C}$
- World's Smallest footprints:
 - 2.5 x 2.0 x 0.75 mm
 - 3.2 x 2.5 x 0.75 mm
 - 5.0 x 3.2 x 0.75 mm
 - 7.0 x 5.0 x 0.90 mm
- All packages are Pb-free and RoHS compliant
- High drive option: 30pF load (contact factory)

Benefits

- Dramatically reduces EMI up to -16 dB
- Services most PC peripherals, networking, and consumer applications
- Provides wide range of spread percentage for maximum electromagnetic interference (EMI) reduction
- Ultra-reliable start up and greater Immunity from Interference
- Factory programmable for ultra-fast lead time
- No crystal or load capacitors required
- Eliminates crystal qualification time
- 50%+ board saving space
- Completely quartz-free

Applications

- Set-top boxes and LCD displays
- Scanners, Printers and Copiers
- Interface Controllers and Graphics Cards
- PCI, CPU and Memory Buses
- Routers and Modems

Block Diagram

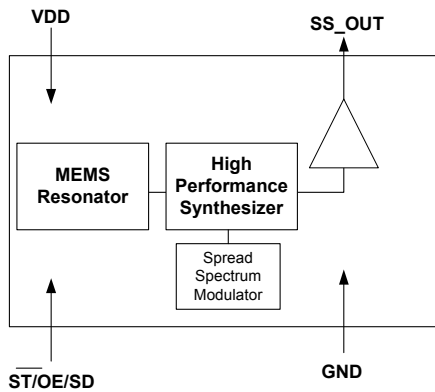

Pinout

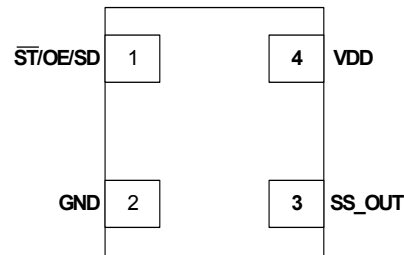

Pin Description

Pin No.	Name	Pin Description
1	$\overline{\text{ST/OE/SD}}$	Standby/ Output Enable/ Spread Disable
2	GND	Connect to Ground
3	SS_OUT	1 to 200 MHz Spread Spectrum Clock Output
4	VDD	Connect to 1.8V or 2.5V or 3.3V

Pin1

Pin #1 Functionality
OE
H or Open; specified frequency output
L: output is high impedance
ST
H or Open; specified frequency output
L: output is low level (weak pull down) Oscillation stops
SD (Down Spread Only)
H or Open: Spread = ON
L : Spread =OFF

Spread Spectrum Modes

Center Spread	Code	1	2	3
	Percentage	±1.0%	±0.50%	±0.25%
Down Spread	Code	4	5	6
	Percentage	-2.0%	-1.0%	-0.50%

In both modes, triangle modulation is employed with a frequency of ~32 kHz.

Down Spread: -2%

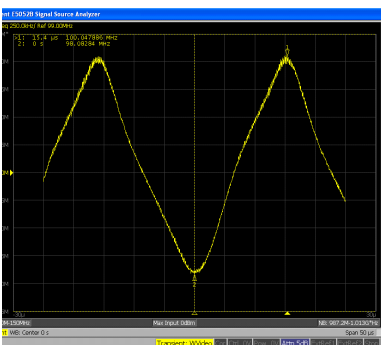

Down Spread: -1%

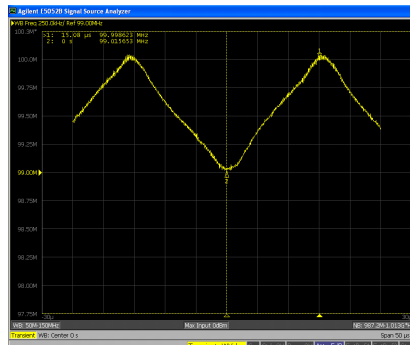

Down Spread: -0.5%

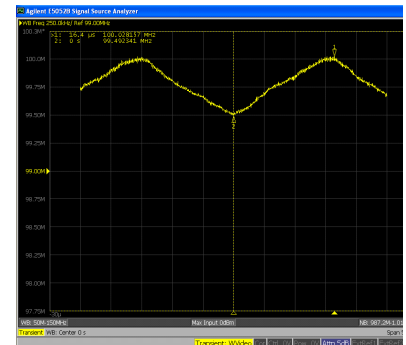

The SiT9001 can be factory programmed to provide down spread modulation or center spread modulation. In the down spread modulation mode, pin 1 can be factory programmed as a spread disable pin. In both the down spread and center spread modulation modes, pin can be factory programmed to be either output enable or standby.

Description

The SiT9001 is a spread-spectrum capable, programmable MEMS oscillator. The SiT9001 offers unparalleled flexibility in terms of frequency range, frequency accuracy stability, supply voltage, and operating temperature range while simultaneously offering outstanding performance in terms of low jitter and a higher frequency range. This flexibility and high performance is made available in packages down to 2.5 x 2.0 mm, making the SiT9001 the smallest programmable spread-spectrum oscillator available.

The SiT9001 is factory programmable and offers two types of spread modulation: down spread modulation, and center

spread modulation. In down spread modulation mode, a spread disable pin is available (Pin 1).

Power down (either output enable or standby) mode options are available for both down spread and center spread versions of the SiT9001.

The SiT9001, by eliminating the quartz crystal, has improved immunity, shock, strain and humidity.

To order samples, go to www.sitime.com and click on Request Sample" link.

Absolute Maximum Ratings

Attempted operation outside the absolute maximum ratings of the part may cause permanent damage to the part. Actual performance of the IC is only guaranteed within the operational specifications not absolute maximum ratings.

Absolute Maximum Table

Parameter	Min.	Max.	Unit
Storage Temperature	-65	150	°C
VDD	-0.5	+3.66	V
Electrostatic Discharge	–	2000	V
Theta JA (with copper plane on VDD and GND)	–	75	°C/W
Theta JC (with PCB traces of 0.010 inch to all pins)	–	24	°C/W
Soldering Temperature (follow standard Pb free soldering guidelines)	–	260	°C
Number of Program Writes	–	1	NA
Program Retention over -40 to 125C, Process, VDD (0 to 3.65V)	–	1,000+	years

Operating Conditions

Parameter	Min.	Typ.	Max.	Unit
Supply Voltages, VDD ^[1]	2.97	3.3	3.63	V
	2.25	2.5	2.75	V
	1.7	1.8	1.9	V
Frequency Stability, Spread = OFF (down spread only) (Inclusive of Initial stability, operating temperature, rated power supply voltage change, load change, aging (1 ppm first year @ 25°C), shock and vibration)	-50	–	+50	ppm
	-100	–	+100	ppm
Extended Commercial Operating Temperature	-20	–	70	°C
Industrial Operating Temperature	-40	–	85	°C
Maximum Load Capacitance ^[2]	–	–	15	pF

Environmental Compliance

Parameter	Condition/Test Method
Mechanical Shock	MIL-STD-883F, Method 2002
Mechanical Vibration	MIL-STD-883F, Method 2007
Temperature Cycle	JESD22, Method A104
Solderability	MIL-STD-883F, Method 2003
Moisture Sensibility Level	MSL1 @ 260°C

Notes:

1. The 3.3V device can operate from 2.25V to 3.63V with higher output drive strength, however, the data sheet specifications cannot be guaranteed. Please contact factory for this option.
2. The output driver strength can be programmed to drive up to 30pF load. Please contact factory for this option.

DC Electrical Specifications

VDD=3.3V ±10%, -40 to 85°C

Parameter	Condition	Min.	Typ.	Max.	Unit
Output Voltage High	IOH = -9 mA	90	–	–	%Vdd
Output Voltage Low	IOL = 9 mA	–	–	10	%Vdd
Input Voltage High	Pin 1	70	–	–	%Vdd
Input Voltage Low	Pin 1	–	–	30	%Vdd
Operating Current	Output frequency = 30 MHz, 15 pF load	–	–	27	mA
	Output frequency = 125 MHz, 15 pF load	–	–	34	mA
Standby Current	Output is weakly pulled down, ST = GND	–	30	50	uA
Power Up Time	Time from minimum power supply voltage to the first cycle (Guaranteed no runt pulses)	–	–	10	ms

VDD=2.5V ±10%, -40 to 85°C

Parameter	Condition	Min.	Typ.	Max.	Unit
Output Voltage High	IOH = -7 mA	90	–	–	%Vdd
Output Voltage Low	IOL = 7 mA	–	–	10	%Vdd
Input Voltage High	Pin 1	70	–	–	%Vdd
Input Voltage Low	Pin 1	–	–	30	%Vdd
Operating Current	Output frequency = 30 MHz, 15 pF load	–	–	26	mA
	Output frequency = 125 MHz, 15 pF load	–	–	31	mA
Standby Current	Output is weakly pulled down, ST = GND	–	30	50	uA
Power Up Time	Time from minimum power supply voltage to the first cycle (Guaranteed no runt pulses)	–	–	10	ms

VDD=1.8V ±5%, -40 to 85°C

Parameter	Condition	Min.	Typ.	Max.	Unit
Output Voltage High	IOH = -5 mA	90	–	–	%Vdd
Output Voltage Low	IOL = 5mA	–	–	10	%Vdd
Input Voltage High	Pin 1	70	–	–	%Vdd
Input Voltage Low	Pin 1	–	–	30	%Vdd
Operating Current	Output frequency = 30 MHz, 15 pF load	–	–	26	mA
	Output frequency = 125 MHz, 15 pF load	–	–	31	mA
Standby Current	Output is weakly pulled down, ST = GND	–	30	50	uA
Power Up Time	Time from minimum power supply voltage to the first cycle (Guaranteed no runt pulses)	–	–	10	ms

AC Electrical Specifications

VDD=3.3V ±10%, -40 to 85°C

Parameter	Condition	Min.	Typ.	Max.	Unit
Clock Output Frequency		1	–	200	MHz
Clock Output Duty Cycle	Output frequency= 1MHz to 75MHz	45	50	55	%
	Output frequency= 75MHz to 200MHz	40	–	60	%
Clock Output Rise Time	15 pF Load, 20% to 80% VDD	–	1.0	1.5	ns
Clock Output Fall Time	15 pF Load, 80% to 20% VDD	–	1.0	1.5	ns
Cycle-to-cycle Jitter	Spread = OFF, Output frequency = 133.33 MHz	–	22	29	ps
	Spread = ON, Output frequency = 133.33 MHz 2% down spread	–	22	29	ps

VDD=2.5V ±10%, -40 to 85°C

Parameter	Condition	Min.	Typ.	Max.	Unit
Clock Output Frequency		1	–	200	MHz
Clock Output Duty Cycle	Output frequency= 1MHz to 125MHz	45	50	55	%
	Output frequency= 125MHz to 200MHz	40	–	60	%
Clock Output Rise Time	15 pF Load, 20% to 80% VDD	–	1.0	1.5	ns
Clock Output Fall Time	15 pF Load, 80% to 20% VDD	–	1.0	1.5	ns
Cycle-to-cycle Jitter	Spread = OFF, Output frequency = 133.33 MHz	–	26	37	ps
	Spread = ON, Output frequency = 133.33 MHz 2% down spread	–	26	37	ps

VDD=1.8V ±5%, -40 to 85°C

Parameter	Condition	Min.	Typ.	Max.	Unit
Clock Output Frequency		1	–	200	MHz
Clock Output Duty Cycle	Output frequency= 1MHz to 75MHz	45	50	55	%
	Output frequency= 75MHz to 200MHz	40	–	60	%
Clock Output Rise Time	15 pF Load, 20% to 80% VDD	–	1.0	1.5	ns
Clock Output Fall Time	15 pF Load, 80% to 20% VDD	–	1.0	1.5	ns
Cycle-to-cycle Jitter	Spread = OFF, Output frequency = 133.33 MHz	–	45	57	ps
	Spread = ON, Output frequency = 133.33 MHz 2% down spread	–	45	57	ps

Ordering Information

SiT9001AC-14-33E6-123.12345T

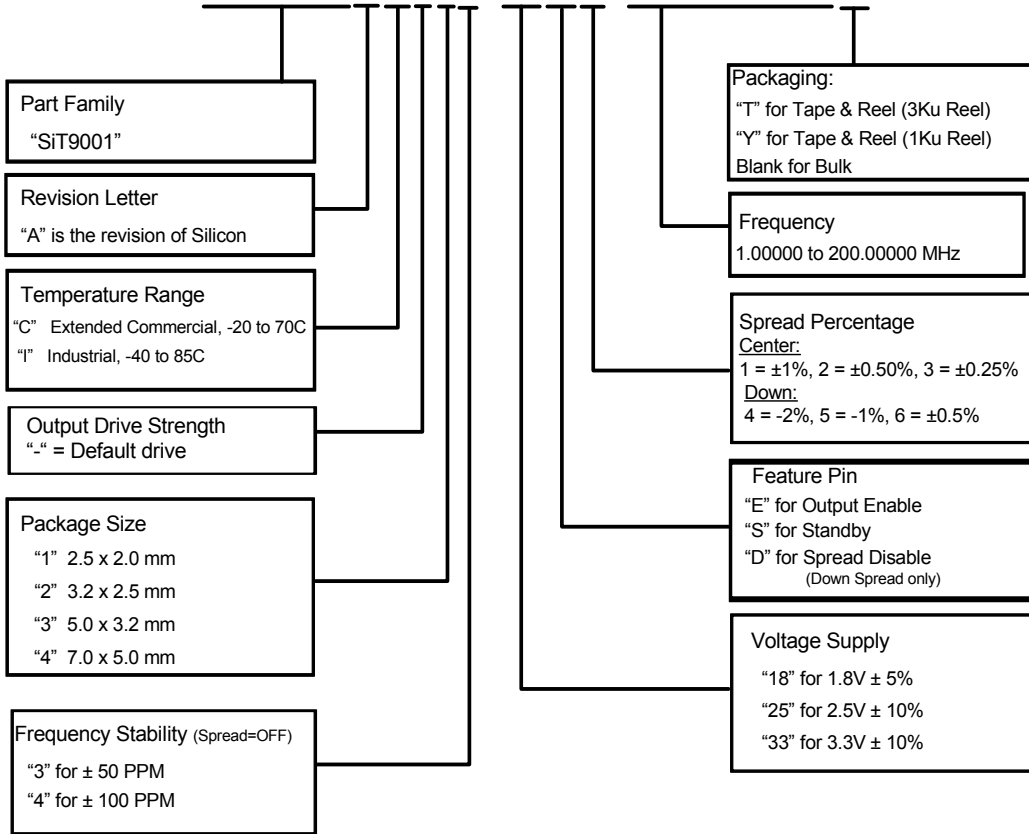

Package Information ^[3]

Dimension (mm)

2.5 x 2.0 x 0.75mm

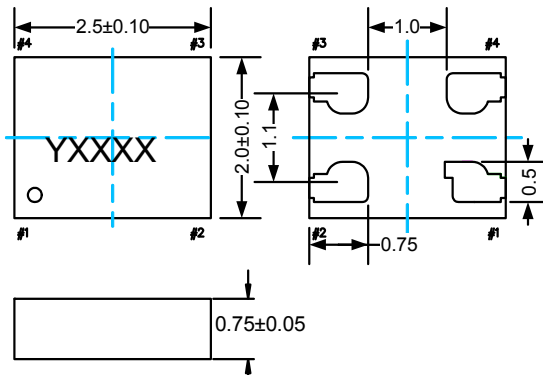

Land Pattern (recommended) (mm)^[4]

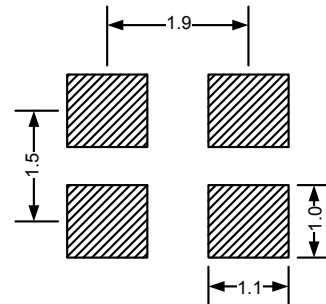

Package Information (continued)^[3]

Dimension (mm)

Land Pattern (recommended) (mm)^[4]

3.2 x 2.5 x 0.75mm

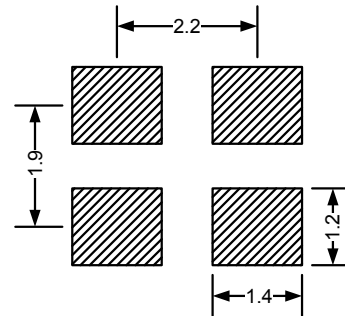
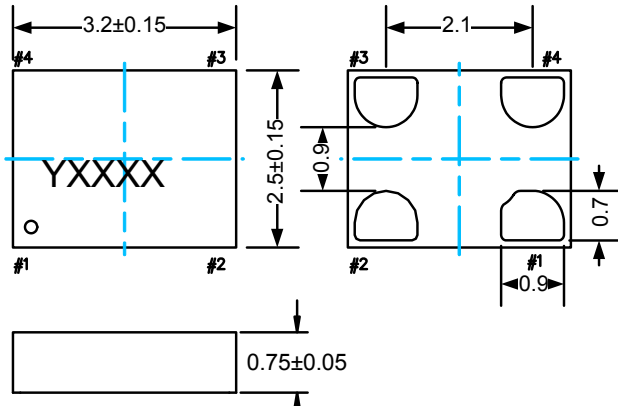

5.0 x 3.2 x 0.75mm

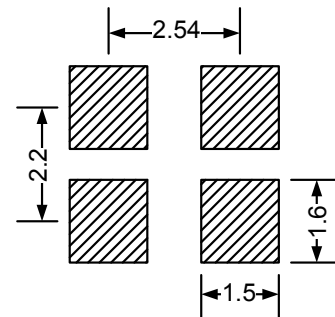
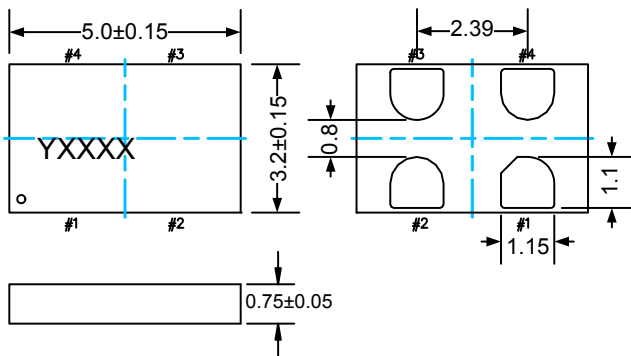

7.0 x 5.0 x 0.90mm

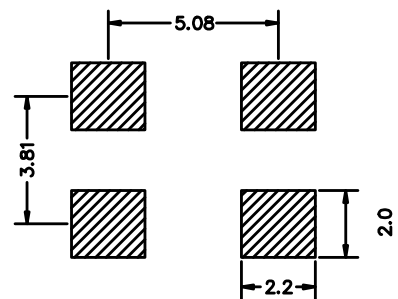
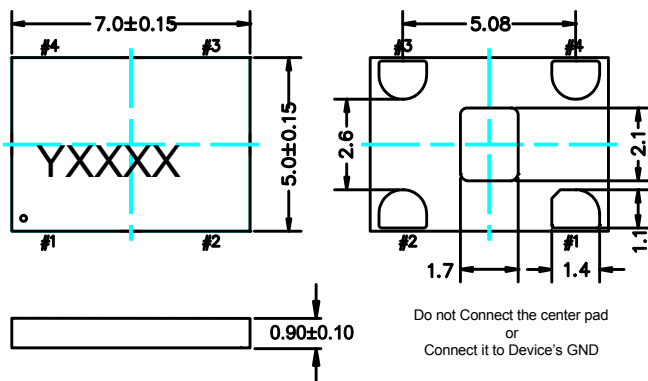

Notes:

3. "Y" denotes manufacturing origin and "XXXX" denotes manufacturing lot number. The value of "Y" depend on the assembly location of the device.
4. A capacitor of value 0.1μF between VDD and GND is recommended.

© SiTime Corporation 2010. The information contained herein is subject to change at any time without notice. SiTime assumes no responsibility or liability for any loss, damage or defect of a Product which is caused in whole or in part by (i) use of any circuitry other than circuitry embodied in a SiTime product, (ii) misuse or abuse including static discharge, neglect or accident, (iii) unauthorized modification or repairs which have been soldered or altered during assembly and are not capable of being tested by SiTime under its normal test conditions, or (iv) improper installation, storage, handling, warehousing or transportation, or (v) being subjected to unusual physical, thermal, or electrical stress.

Disclaimer: sitime makes no warranty of any kind, express or implied, with regard to this material, and specifically disclaims any and all express or implied warranties, either in fact or by operation of law, statutory or otherwise, including the implied warranties of merchantability and fitness for use or a particular purpose, and any implied warranty arising from course of dealing or usage of trade, as well as any common-law duties relating to accuracy or lack of negligence, with respect to this material, any sitime product and any product documentation. products sold by sitime are not suitable or intended to be used in a life support application or component, to operate nuclear facilities, or in other mission critical applications where human life may be involved or at stake. all sales are made conditioned upon compliance with the critical uses policy set forth below.

CRITICAL USE EXCLUSION POLICY
BUYER AGREES NOT TO USE SITIME'S PRODUCTS FOR ANY APPLICATION OR IN ANY COMPONENTS USED IN LIFE SUPPORT DEVICES OR TO OPERATE NUCLEAR FACILITIES OR FOR USE IN OTHER MISSION-CRITICAL APPLICATIONS OR COMPONENTS WHERE HUMAN LIFE OR PROPERTY MAY BE AT STAKE.

SiTime owns all rights, title and interest to the intellectual property related to SiTime's products, including any software, firmware, copyright, patent, or trademark. The sale of SiTime products does not convey or imply any license under patent or other rights. SiTime retains the copyright and trademark rights in all documents, catalogs and plans supplied pursuant to or ancillary to the sale of products or services by SiTime. Unless otherwise agreed to in writing by SiTime, any reproduction, modification, translation, compilation, or representation of this material shall be strictly prohibited.