

DB101-G Thru. DB107-G

Reverse Voltage: 50 to 1000V

Forward Current: 1.0A

RoHS Device

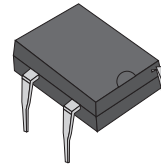

Features

- Rating to 1000V PRV
- Ideal for printed circuit board
- Low forward voltage drop
- High current capability

Mechanical Data

- Case: DB, molded plastic
- Epoxy: UL 94-V0 rate flame retardant.
- Polarit: As marked on Body
- Mounting position: Any
- Weight: 0.53 grams

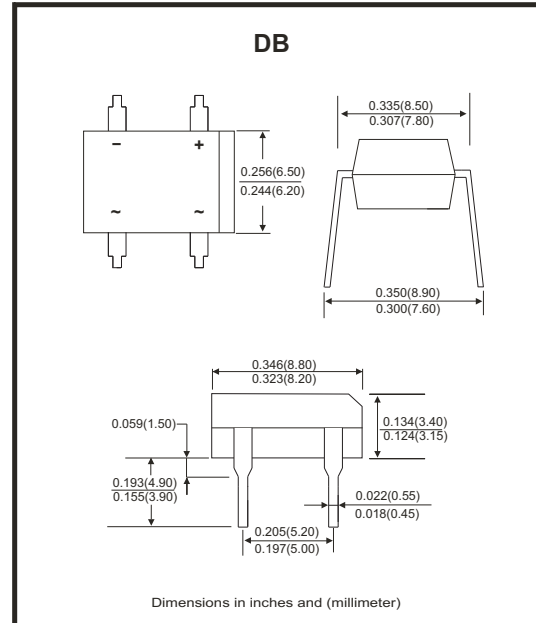

Maximum ratings and electrical characteristics

Rating at 25°C ambient temperature unless otherwise specified.
Single phase, half wave, 60Hz, resistive or inductive load.
For capacitive load, derate current by 20%

Parameter	Symbol	DB101-G	DB102-G	DB103-G	DB104-G	DB105-G	DB106-G	DB107-G	Unit
Maximum Reverse Peak Repetitive Voltage	V_{RRM}	50	100	200	400	600	800	1000	V
Maximum RMS Voltage	V_{RMS}	35	70	140	280	420	560	700	V
Maximum DC Blocking Voltage	V_{DC}	50	100	200	400	600	800	1000	V
Maximum Average Forward Rectified Current @ $T_A=40^\circ\text{C}$	$I_{(AV)}$	1.0							A
Peak Forward Surge Current, 8.3ms Single Half Sine-Wave Super Imposed On Rated Load (JEDEC Method)	I_{FSM}	30							A
$I^2 t$ Rating For Fusing ($t < 8.3\text{ms}$)	$I^2 t$	10.4							$\text{A}^2 \text{s}$
Maximum Forward Voltage At 1.0A DC	V_F	1.1							V
Maximum DC Reverse Current @ $T_J=25^\circ\text{C}$ At Rated DC Blocking Voltage @ $T_J=125^\circ\text{C}$	I_R	10 500							μA
Typical Junction Capacitance (Note 1)	C_J	25							pF
Typical Thermal Resistance (Note 2)	$R_{\theta JA}$	40							$^\circ\text{C/W}$
Operating Temperature Range	T_J	-55 ~ +150							$^\circ\text{C}$
Storage Temperature Range	T_{STG}	-55 ~ +150							$^\circ\text{C}$

Notes:

1. Measured at 1.0MHz and applied reverse voltage of 4.0V DC.
2. Thermal resistance from junction to ambient mounted on P.C.B with 0.5"×0.5" (13×13mm) copper pads.

Rating and Characteristics Curves (DB101-G Thru. DB107-G)

Fig.1 - Forward Current Derating Curve

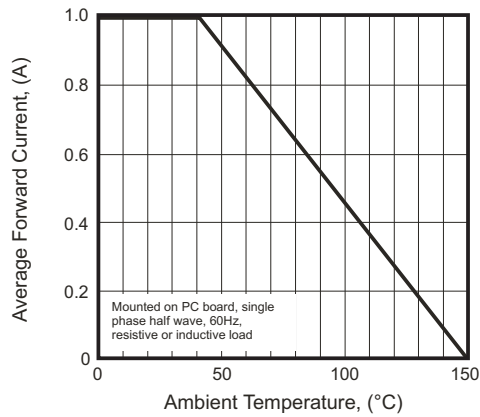

Fig.2 - Typical Forward Characteristics

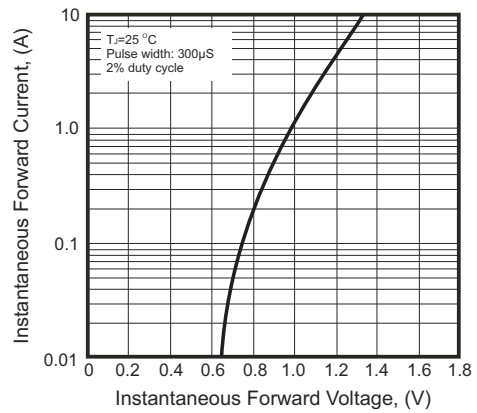

Fig.3 - Maximum Non-repetitive Surge Current

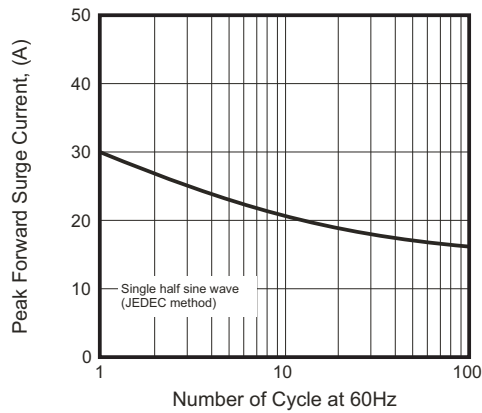

Fig.4 - Typical Junction Capacitance

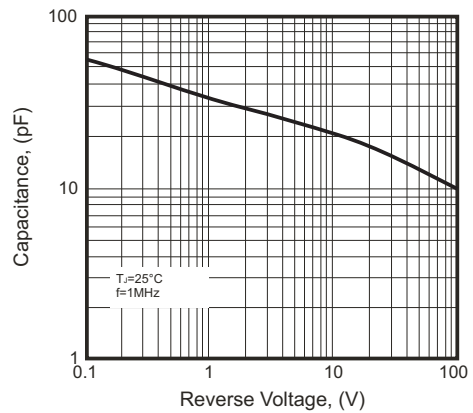
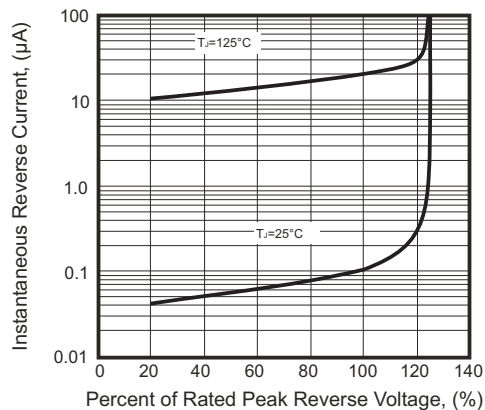

Fig.5 - Typical Reverse Characteristics



Marking Code

Part Number	Marking code
DB101-G	DB101
DB102-G	DB102
DB103-G	DB103
DB104-G	DB104
DB105-G	DB105
DB106-G	DB106
DB107-G	DB107

Standard Packaging

Case Type	TUBE PACK	
	TUBE (pcs)	BOX (pcs)
DB	50	2,500