

DF005S-G Thru. DF10S-G

Reverse Voltage: 50 to 1000V

Forward Current: 1.0A

RoHS Device

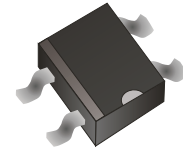

Features

- Rating to 1000V PRV
- Ideal for printed circuit board
- Low forward voltage drop,high current capability
- Reliable low cost construction utilizing molded plastic technique results in inexpensive product
- Lead tin Pb/Sn copper
- The plastic material has UL flammability classification 94V-0

Mechanical Data

- Polarit:As marked on Body
- Weight: 0.34 grams
- Mounting position:Any

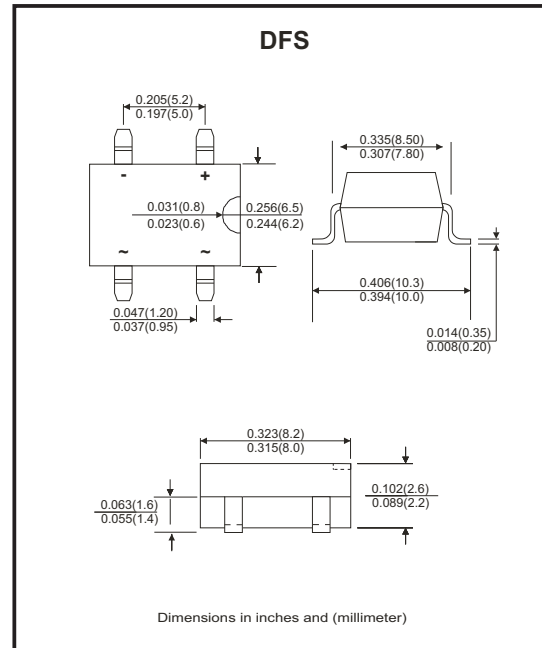

Maximum ratings and electrical characteristics

Rating at 25°C ambient temperature unless otherwise specified.
Single phase, half wave ,60Hz, resistive or inductive load.
For capacitive load, derate current by 20%

Parameter	Symbol	DF005S-G	DF01S-G	DF02S-G	DF04S-G	DF06S-G	DF08S-G	DF10S-G	Unit
Maximum Reverse Peak Repetitive Voltage	V_{RRM}	50	100	200	400	600	800	1000	V
Maximum RMS Voltage	V_{RMS}	35	70	140	280	420	560	700	V
Maximum DC Blocking Voltage	V_{DC}	50	100	200	400	600	800	1000	V
Maximum Average Forward Rectified Current @ $T_A=40^{\circ}C$	$I_{(AV)}$	1.0							A
Peak Forward Surge Current , 8.3ms Single Half Sine-Wave Super Imposed On Rated Load	I_{FSM}	30							A
$I^2 t$ Rating for Fusing ($t < 8.3ms$)	$I^2 t$	10.4							$A^2 s$
Maximum Forward Voltage at 1.0A DC	V_F	1.1							V
Maximum Reverse Current @ $T_J=25^{\circ}C$ At Rated DC Blocking Voltage @ $T_J=125^{\circ}C$	I_R	10 500							μA
Typical Junction Capacitance (Note 1)	C_J	25							pF
Typical Thermal Resistance (Note 2)	$R_{\theta JA}$	40							$^{\circ}C/W$
Operating Temperature Range	T_J	-55 ~ +150							$^{\circ}C$
Storage Temperature Range	T_{STG}	-55 ~ +150							$^{\circ}C$

Notes:

1. Measured at 1.0MHz and applied reverse voltage of 4.0V.
2. Unit mounted on P.C.B with 0.51"×0.51" (13×13mm) copper pads.

Rating and Characteristics Curves (DF005S-G Thru. DF10S-G)

Fig.1 - Forward Current Derating Curve

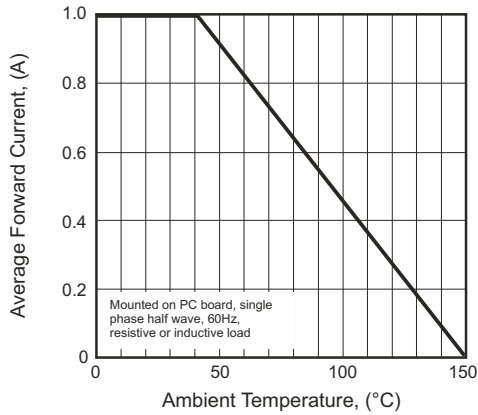

Fig.2 - Maximum Non-repetitive Surge Current

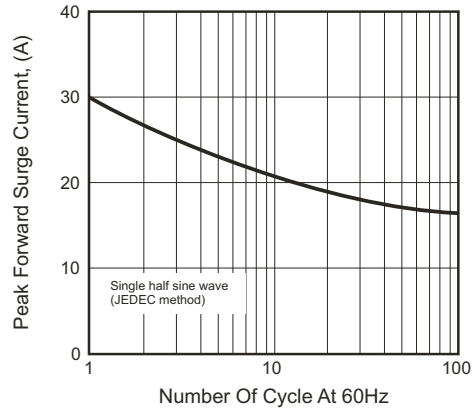

Fig.3 - Typical Junction Capacitance

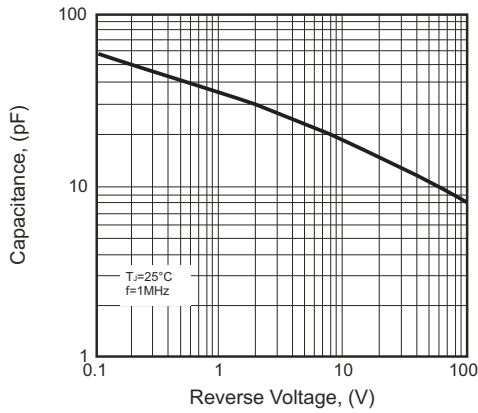

Fig.4 - Typical Forward Characteristics

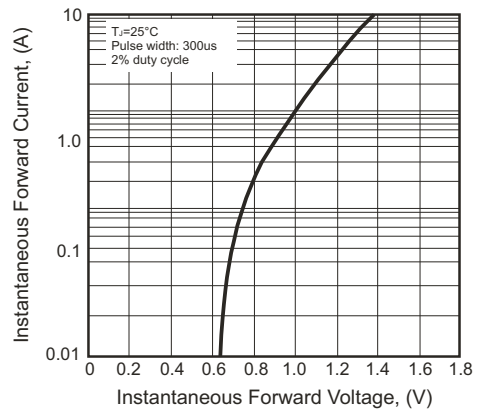
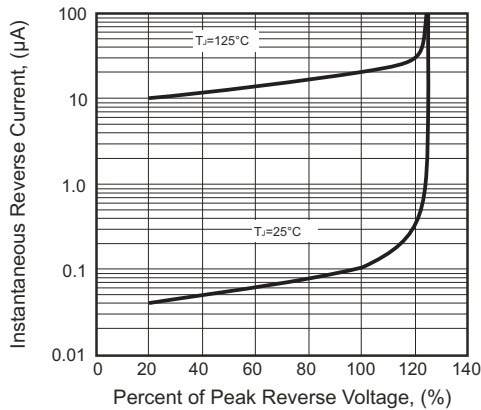
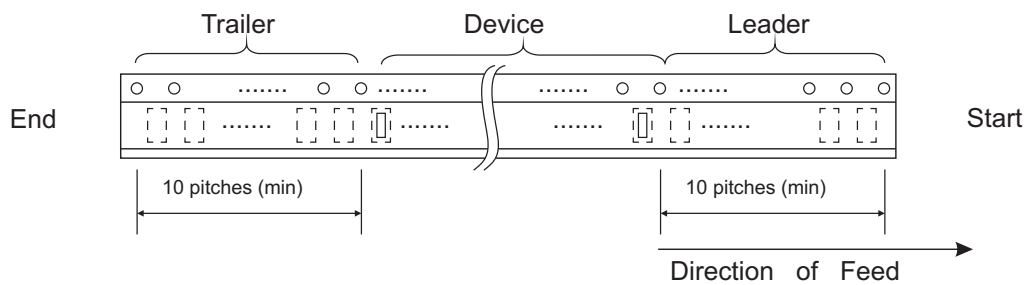
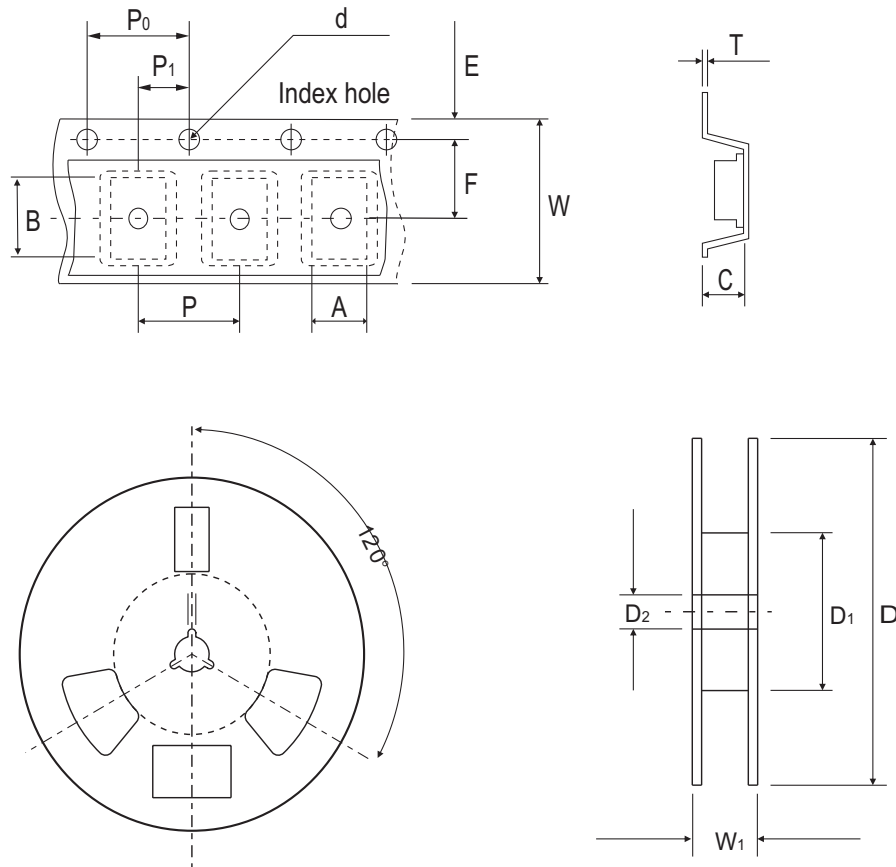

Fig.5 - Typical Reverse Characteristics



Reel Taping Specification



DFS	SYMBOL	A	B	C	d	D	D1	D2
	(mm)	8.64 ± 0.10	10.41 ± 0.10	3.81 ± 0.10	1.55 ± 0.05	330	50.0 MIN.	13.00 ± 0.20
	(inch)	0.340 ± 0.004	0.409 ± 0.004	0.150 ± 0.004	0.061 ± 0.002	13	1.969 MIN.	0.512 ± 0.008

DFS	SYMBOL	E	F	P	P0	P1	T	W	W1
	(mm)	1.75 ± 0.10	7.50 ± 0.05	12.00 ± 0.10	4.00 ± 0.10	2.00 ± 0.10	0.32	16.00 ± 0.30	16.00~18.40
	(inch)	0.069 ± 0.004	0.295 ± 0.002	0.472 ± 0.004	0.157 ± 0.004	0.079 ± 0.004	0.013	0.630 ± 0.012	0.630~0.724

Marking Code

Part Number	Marking code	Packaging
DF005SP-G	DF005S	Tube
DF01SP-G	DF01S	Tube
DF02SP-G	DF02S	Tube
DF04SP-G	DF04S	Tube
DF06SP-G	DF06S	Tube
DF08SP-G	DF08S	Tube
DF10SP-G	DF10S	Tube
DF005ST-G	DF005S	Reel
DF01ST-G	DF01S	Reel
DF02ST-G	DF02S	Reel
DF04ST-G	DF04S	Reel
DF06ST-G	DF06S	Reel
DF08ST-G	DF08S	Reel
DF10ST-G	DF10S	Reel

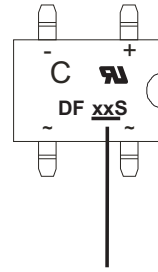

XX / XXX = Product type marking code
C = Comchip Logo

Note:

1) Suffix code after part number to specify packaging item .

Packaging	Code
TUBE PACK	P
REEL PACK	T

Suggested PAD Layout

SIZE	DFS	
	(mm)	(inch)
A	1.20 Min	0.047 Min
B	5.21 REF	0.205 REF
C	1.52 Min	0.060 Min
D	10.26 Max	0.404 Max

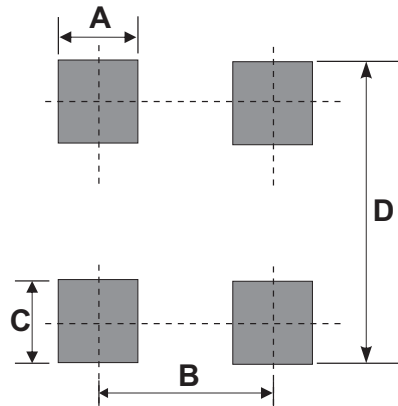

Standard Packaging

Case Type	TUBE PACK	
	TUBE (pcs)	BOX (pcs)
DFS	50	5,000

Case Type	REEL PACK	
	REEL (pcs)	Reel Size (inch)
DFS	1,000	13