

CDST-4148-G

Reverse Voltage: 75 Volts

Forward Current: 150 mA

RoHS Device

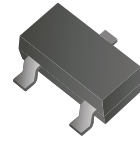

Features

- Design for mounting on small surface.
- High speed switching.
- High mounting capability, strong surge withstand, high reliability.

Mechanical data

- Case: SOT-23, molded plastic.
- Terminals: solderable per MIL-STD-750, method 2026.
- Approx. weight: 0.0078 grams

Circuit diagram

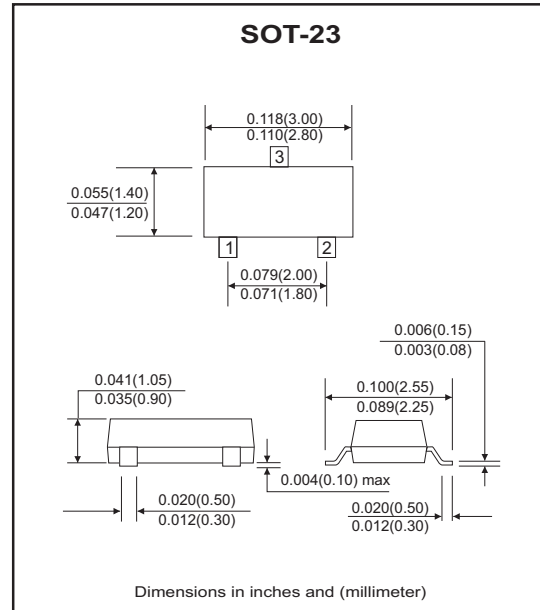
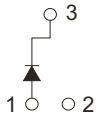

Maximum Ratings and Electrical Characteristics, Single Diode

(at Ta=25°C unless otherwise noted)

Parameter	Symbol	Conditions	Min.	Typ.	Max.	Units
Peak Repetitive peak reverse voltage	V_{RRM}				75	V
RMS reverse voltage	V_{RMS}				53	V
DC Blocking voltage	V_{DC}				75	V
Forward continuous current	I_{FM}				300	mA
Average forward current	I_o				150	mA
Peak forward surge current	I_{FSM}	$T=1.0 \mu S$ $T=1.0 S$			2.0 1.0	A
Power dissipation	P_D				350	mW
Thermal resistance junction to ambient	$R_{\theta JA}$				357	°C/W
Reverse breakdown voltage	$V_{(BR)R}$	$I_R=100\mu A$	75			V
Forward voltage	V_F	@ $I_F=1mA$ @ $I_F=10mA$ @ $I_F=50mA$ @ $I_F=150mA$			0.715 0.855 1.0 1.25	V
Reverse current	I_R	@ $V_R=20V$ @ $V_R=75V$			25 2.5	nA μA
Reverse recovery time	T_{rr}	$I_F=I_R=10mA$, $1_{rr}=0.1 \cdot I_R$ $R_L=100\Omega$			4	nS
Capacitance between terminals	C_T	$V_R=0V$, $f=1.0MHz$			2	pF
Junction temperature	T_J				+150	°C
Storage temperature	T_{STG}		-65		+150	°C

RATING AND CHARACTERISTIC CURVES (CDST-4148-G)

Fig.1 - Forward Characteristics

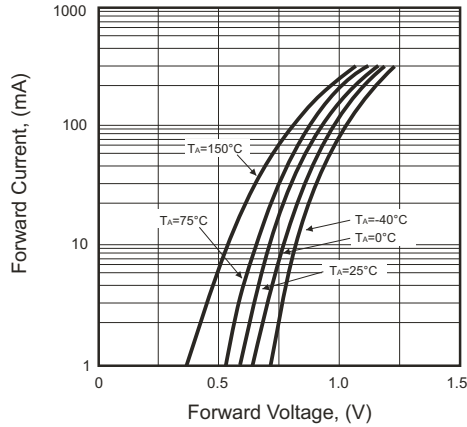

Fig.2 - Power Derating Curve

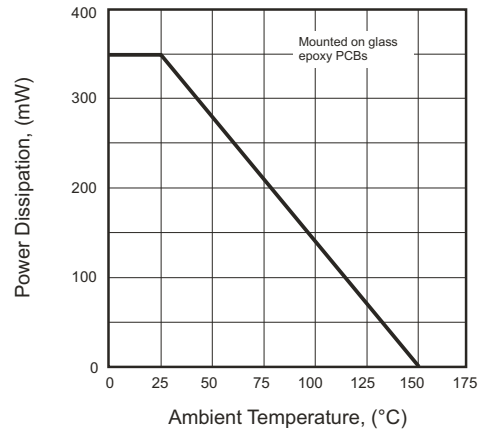

Fig.3 - Reverse Characteristics

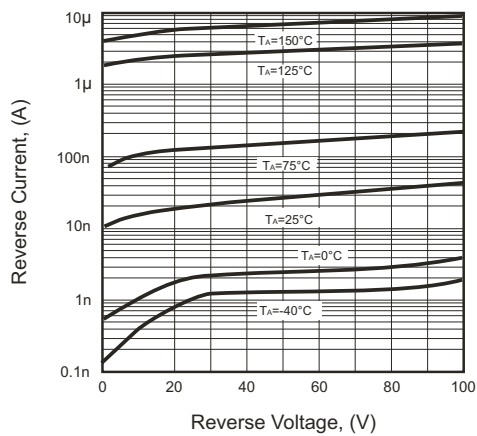

Fig.4 - Capacitance Between Terminals Characteristics

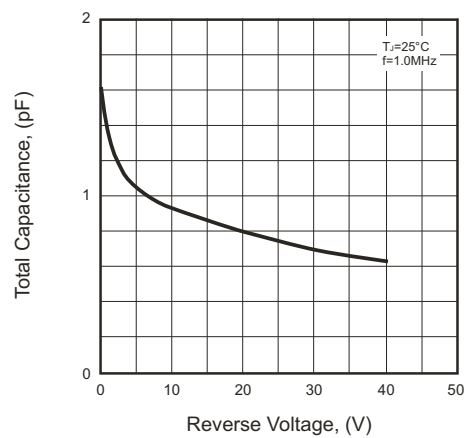

Fig.5 - Forward Characteristics

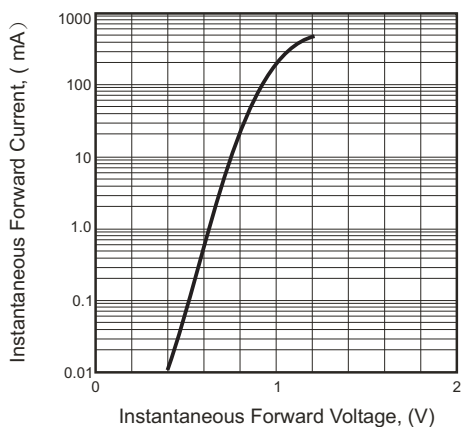
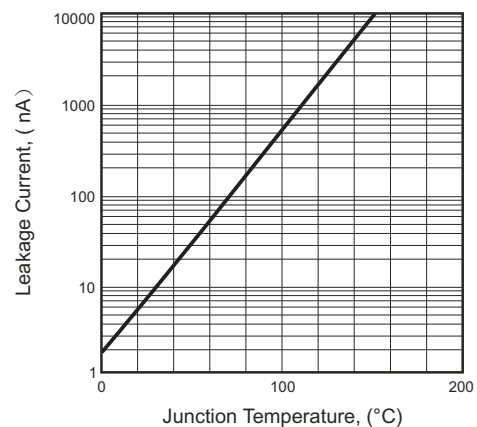
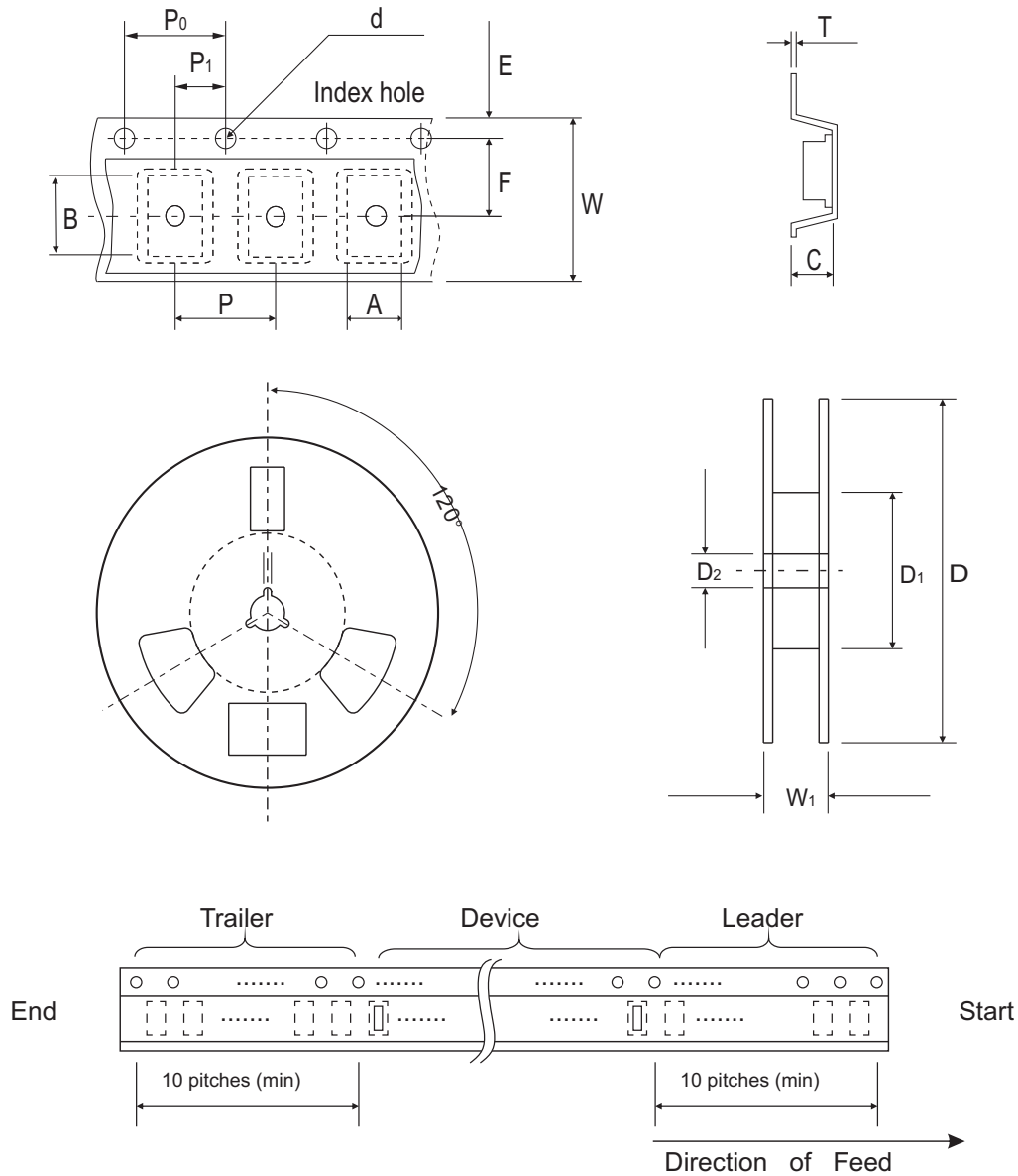

Fig.6 - Leakage Current vs Junction Temperature



Reel Taping Specification



SOT-23	SYMBOL	A	B	C	d	D	D1	D2
	(mm)	3.15 ± 0.10	2.77 ± 0.10	1.22 ± 0.10	1.50 ± 0.10	178 ± 1.00	54.40 ± 0.40	13.00 ± 0.20
	(inch)	0.124 ± 0.004	0.109 ± 0.004	0.048 ± 0.004	0.059 ± 0.004	7.008 ± 0.039	2.142 ± 0.016	0.512 ± 0.008

SOT-23	SYMBOL	E	F	P	P0	P1	W	W1
	(mm)	1.75 ± 0.10	3.50 ± 0.05	4.00 ± 0.10	4.00 ± 0.10	2.00 ± 0.10	8.00 + 0.30 / - 0.10	9.50 ± 1.00
	(inch)	0.069 ± 0.004	0.138 ± 0.002	0.158 ± 0.004	0.158 ± 0.004	0.079 ± 0.004	0.315 + 0.012 / - 0.004	0.374 ± 0.039

Marking Code

Part Number	Marking Code
CDST-4148-G	KA2

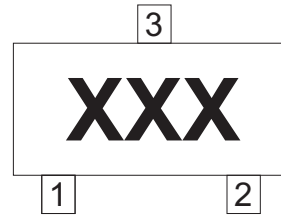

xxx = Product type marking code

Suggested PAD Layout

SIZE	SOT-23	
	(mm)	(inch)
A	0.80	0.031
B	1.90	0.075
C	2.02	0.080
D	2.82	0.111

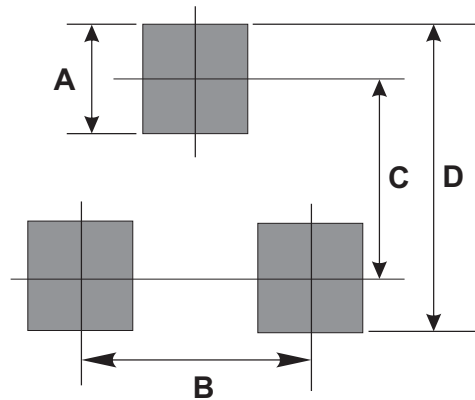

Standard Packaging

Case Type	REEL PACK	
	REEL (pcs)	Reel Size (inch)
SOD-23	3,000	7