

CDSV-19-G/-20-G/-21-G RoHS Device

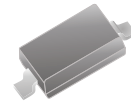

Features

- Fast switching speed.
- Small surface mount type, ideally suited for automatic insertion.
- Low reverse current and low forward voltage.
- High reliability.
- For general purpose switching applications.

Mechanical data

- Case: SOD-323, Molded Plastic
- Terminals: Solderable per MIL-STD-202, Method 208
- Weight: 0.01 gram(approx.)

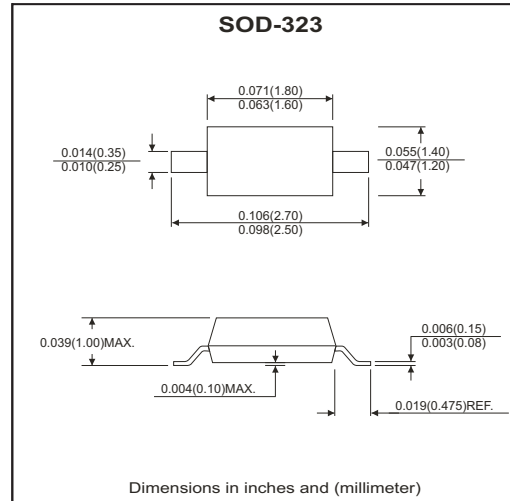

Maximum Ratings (at Ta=25°C unless otherwise noted)

Parameter	Symbol	CDSV-19-G	CDSV-20-G	CDSV-21-G	Unit
Non-repetitive peak reverse voltage	V_{RM}	120	200	250	V
Repetitive peak reverse voltage	V_{RRM}				
Working peak reverse voltage	V_{RWM}	100	150	200	V
DC blocking voltage	V_R				
RMS reverse voltage	$V_{R(RMS)}$	71	106	141	V
Forward continuous current (Note 1)	I_{FM}	400			mA
Average rectified output current (Note 1)	I_o	200			mA
Non-repetitive peak forward surge current @t=1.0uS @t=1.0S	I_{FSM}	2.5 0.5			A
Repetitive peak forward surge current	I_{FRM}	625			mA
Power dissipation	P_D	250			mW
Thermal resistance junction to ambient air (Note 1)	$R_{\theta JA}$	500			°C/W
Operating and storage temperature range	T_J, T_{STG}	-65 ~ +150			°C

Electrical Characteristics (at Ta=25°C unless otherwise noted)

Parameter	Symbol	Conditions	Min	Typ.	Max	Unit
Forward voltage	V_F	$I_F=100mA$ $I_F=200mA$	----	----	1.0 1.25	V
Reverse current	I_R	$V_R=100V$ $V_R=150V$ $V_R=200V$	----	----	0.1 0.1 0.1	μA
Capacitance between terminals	C_T	$V_R=0V, f=1.0MHz$	----	----	5.0	pF
Reverse recovery time	t_{rr}	$I_F=I_R=30mA$ $I_{rr}=0.1X I_R, R_L=100\Omega$	----	----	50	nS

RATING AND CHARACTERISTIC CURVES (CDSV-19-G/-20-G/-21-G)

Fig.1 - Power Derating Curve

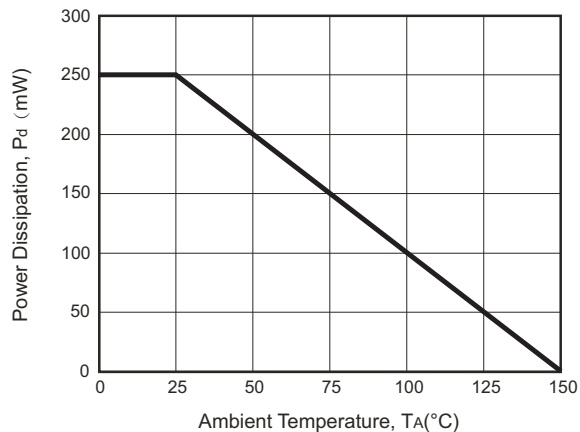

Fig.2 - Typical Forward Characteristics

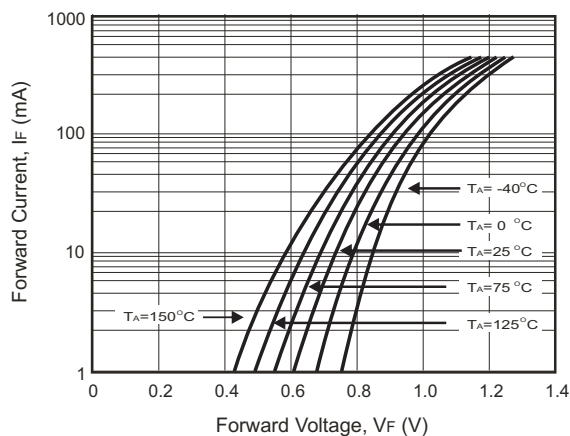

Fig.3 - Typical Reverse Characteristics

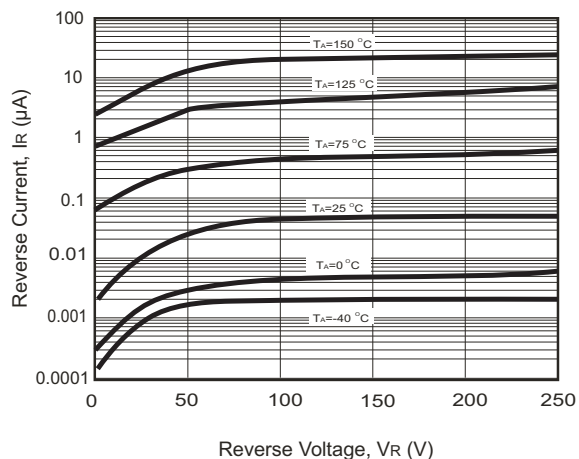
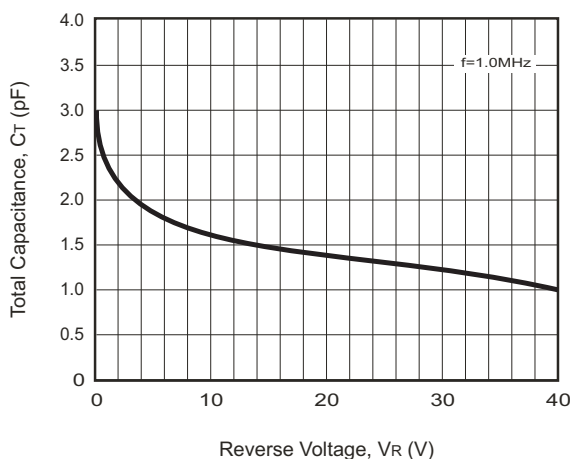
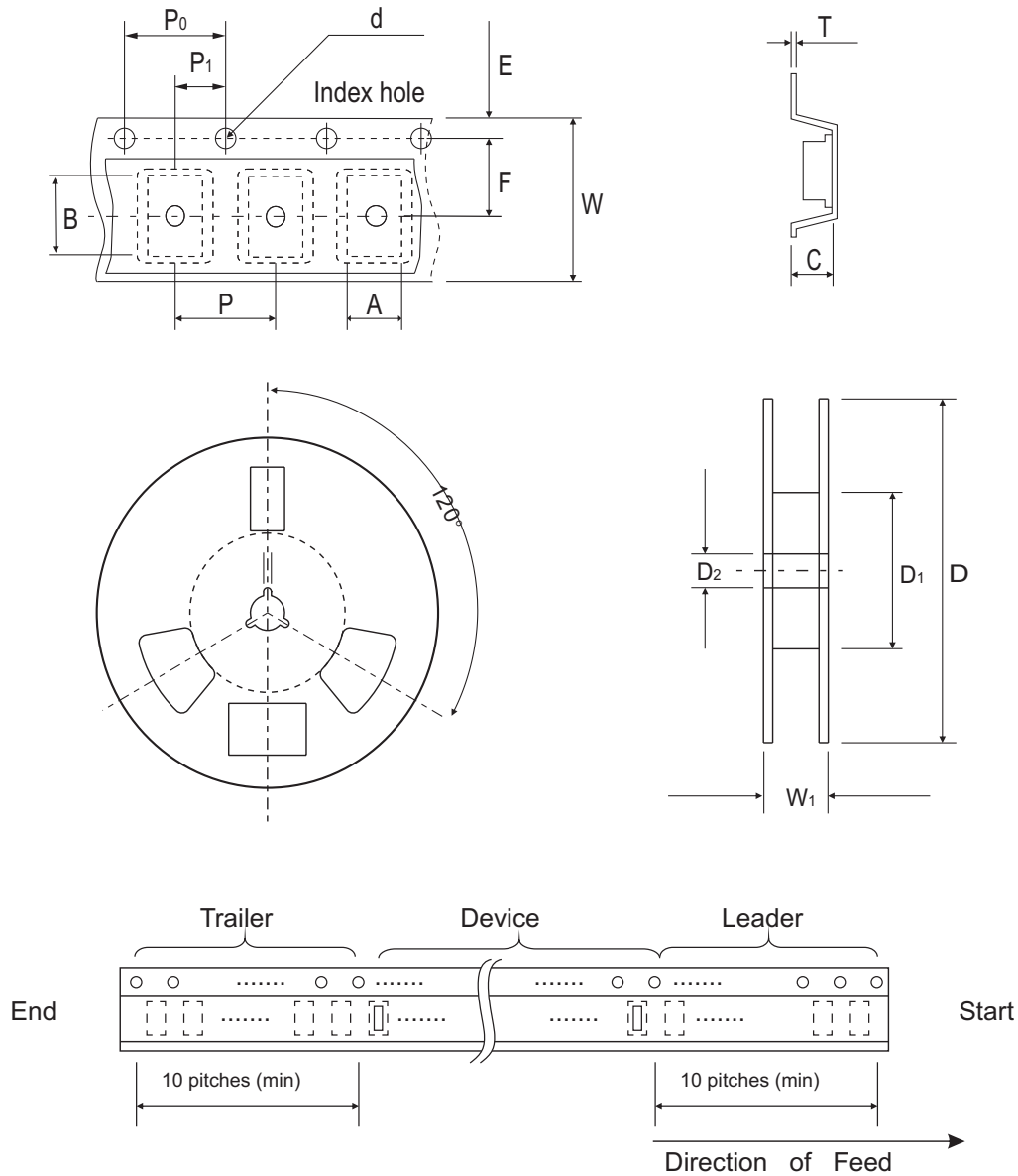

Fig.4 - Typical Capacitance vs. Reverse Voltage



Reel Taping Specification



SOD-323	SYMBOL	A	B	C	d	D	D1	D2
	(mm)	1.46 ± 0.10	2.90 ± 0.10	1.25 ± 0.10	1.50 ± 0.10	178 ± 1.00	54.40 ± 0.40	13.00 ± 0.20
	(inch)	0.058 ± 0.004	0.114 ± 0.004	0.049 ± 0.004	0.059 ± 0.004	7.009 ± 0.039	2.142 ± 0.016	0.512 ± 0.008

SOD-323	SYMBOL	E	F	P	P0	P1	W	W1
	(mm)	1.75 ± 0.10	3.50 ± 0.05	4.00 ± 0.10	4.00 ± 0.10	2.00 ± 0.10	8.00 + 0.30 / - 0.10	9.50 ± 1.00
	(inch)	0.069 ± 0.004	0.138 ± 0.002	0.158 ± 0.004	0.158 ± 0.004	0.079 ± 0.004	0.315 + 0.012 / - 0.004	0.374 ± 0.039

Marking Code

Part Number	Marking Code
CDSV-19-G	A8
CDSV-20-G	T2
CDSV-21-G	T3



xx= Product type marking code

Suggested PAD Layout

SIZE	SOD-323	
	(mm)	(inch)
A	2.33	0.132
B	0.70	0.028
C	0.70	0.028
D	3.03	0.120
E	1.63	0.064

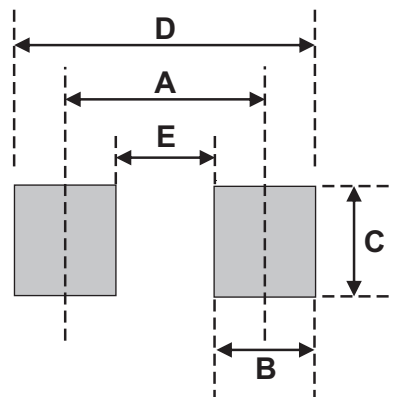

Standard Packaging

Case Type	REEL PACK	
	REEL (pcs)	Reel Size (inch)
SOD-323	3,000	7