

# 1SMA59xxBT3G Series, SZ1SMA59xxBT3G Series

## 1.5 Watt Plastic Surface Mount Zener Voltage Regulators

This complete new line of 1.5 Watt Zener Diodes offers the following advantages.

### Features

- Standard Zener Breakdown Voltage Range – 3.3 V to 68 V
- ESD Rating of Class 3 (> 16 kV) per Human Body Model
- Flat Handling Surface for Accurate Placement
- Package Design for Top Slide or Bottom Circuit Board Mounting
- Low Profile Package
- Ideal Replacement for MELF Packages
- AEC-Q101 Qualified and PPAP Capable – SZ1SMA59xxBT3G
- SZ Prefix for Automotive and Other Applications Requiring Unique Site and Control Change Requirements
- Pb-Free Packages are Available\*

### Mechanical Characteristics:

**CASE:** Void-free, transfer-molded plastic

**FINISH:** All external surfaces are corrosion resistant with readily solderable leads

**MAXIMUM CASE TEMPERATURE FOR SOLDERING PURPOSES:**  
260°C for 10 seconds

**POLARITY:** Cathode indicated by molded polarity notch or cathode band

**FLAMMABILITY RATING:** UL 94 V-0 @ 0.125 in

### MAXIMUM RATINGS

Rating	Symbol	Value	Unit
DC Power Dissipation @ $T_L = 75^\circ\text{C}$ , Measured Zero Lead Length (Note 1) Derate above $75^\circ\text{C}$	$P_D$	1.5 20	W mW/°C
Thermal Resistance, Junction-to-Lead	$R_{\theta JL}$	50	°C/W
DC Power Dissipation @ $T_A = 25^\circ\text{C}$ (Note 2) Derate above $25^\circ\text{C}$	$P_D$	0.5 4.0	W mW/°C
Thermal Resistance, Junction-to-Ambient	$R_{\theta JA}$	250	°C/W
Operating and Storage Temperature Range	$T_J, T_{stg}$	-65 to +150	°C

Stresses exceeding Maximum Ratings may damage the device. Maximum Ratings are stress ratings only. Functional operation above the Recommended Operating Conditions is not implied. Extended exposure to stresses above the Recommended Operating Conditions may affect device reliability.

1. 1 in square copper pad, FR-4 board.
2. FR-4 Board, using ON Semiconductor minimum recommended footprint.

\*For additional information on our Pb-Free strategy and soldering details, please download the ON Semiconductor Soldering and Mounting Techniques Reference Manual, SOLDERRM/D.



ON Semiconductor®

<http://onsemi.com>



SMA  
CASE 403D  
PLASTIC  
STYLE 1

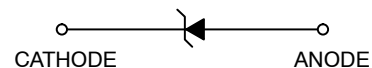

### MARKING DIAGRAM

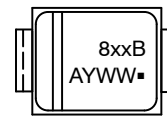

- 8xxB = Device Code (Refer to page 2)
- A = Assembly Location
- Y = Year
- WW = Work Week
- = Pb-Free Package

### ORDERING INFORMATION

Device	Package	Shipping†
1SMA59xxBT3G	SMA (Pb-Free)	5,000 / Tape & Reel
SZ1SMA59xxBT3G	SMA (Pb-Free)	5,000 / Tape & Reel

†For information on tape and reel specifications, including part orientation and tape sizes, please refer to our Tape and Reel Packaging Specifications Brochure, BRD8011/D.

### DEVICE MARKING INFORMATION

See specific marking information in the device marking column of the Electrical Characteristics table on page 2 of this data sheet.

# 1SMA59xxBT3G Series, SZ1SMA59xxBT3G Series

**ELECTRICAL CHARACTERISTICS** ( $T_A = 25^\circ\text{C}$  unless otherwise noted,  $V_F = 1.5\text{ V Max.}$  @  $I_F = 200\text{ mA}$  for all types)

Symbol	Parameter
$V_Z$	Reverse Zener Voltage @ $I_{ZT}$
$I_{ZT}$	Reverse Current
$Z_{ZT}$	Maximum Zener Impedance @ $I_{ZT}$
$I_{ZK}$	Reverse Current
$Z_{ZK}$	Maximum Zener Impedance @ $I_{ZK}$
$I_R$	Reverse Leakage Current @ $V_R$
$V_R$	Reverse Voltage
$I_F$	Forward Current
$V_F$	Forward Voltage @ $I_F$
$I_{ZM}$	Maximum DC Zener Current

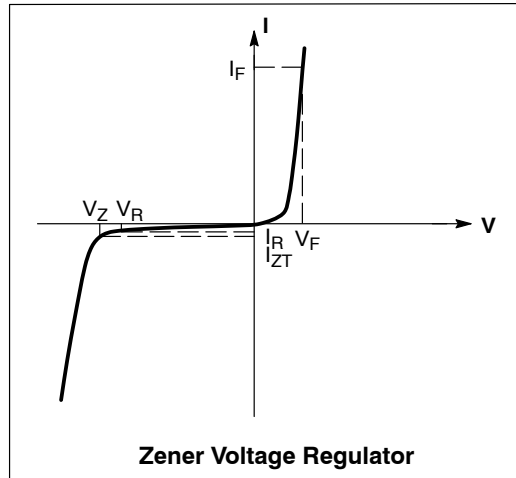

**ELECTRICAL CHARACTERISTICS** ( $T_A = 25^\circ\text{C}$  unless otherwise noted,  $V_F = 1.5\text{ V Max.}$  @  $I_F = 200\text{ mA}$  for all types)

Device* (Note 3)	Device Marking	Zener Voltage (Note 4)				Zener Impedance			Leakage Current		$I_{ZM}$
		$V_Z$ (Volts)			@ $I_{ZT}$	$Z_{ZT}$ @ $I_{ZT}$	$Z_{ZK}$ @ $I_{ZK}$	$I_R$ @ $V_R$			
		Min	Nom	Max	mA	$\Omega$	$\Omega$	mA	$\mu\text{A}$	Volts	
1SMA5913BT3G	813B	3.13	3.3	3.47	113.6	10	500	1.0	50	1.0	455
1SMA5914BT3G	814B	3.42	3.6	3.78	104.2	9.0	500	1.0	35.5	1.0	417
1SMA5915BT3G	815B	3.70	3.9	4.10	96.1	7.5	500	1.0	12.5	1.0	385
1SMA5916BT3G	816B	4.08	4.3	4.52	87.2	6.0	500	1.0	2.5	1.0	349
1SMA5917BT3G	817B	4.46	4.7	4.94	79.8	5.0	500	1.0	2.5	1.5	319
1SMA5918BT3G	818B	4.84	5.1	5.36	73.5	4.0	350	1.0	2.5	2.0	294
1SMA5919BT3G	819B	5.32	5.6	5.88	66.9	2.0	250	1.0	2.5	3.0	268
1SMA5920BT3G	820B	5.89	6.2	6.51	60.5	2.0	200	1.0	2.5	4.0	242
1SMA5921BT3G	821B	6.46	6.8	7.14	55.1	2.5	200	1.0	2.5	5.2	221
1SMA5922BT3G	822B	7.12	7.5	7.88	50	3.0	400	0.5	2.5	6.0	200
1SMA5923BT3G	823B	7.79	8.2	8.61	45.7	3.5	400	0.5	2.5	6.5	183
1SMA5924BT3G	824B	8.64	9.1	9.56	41.2	4.0	500	0.5	2.5	7.0	165
1SMA5925BT3G	825B	9.5	10	10.5	37.5	4.5	500	0.25	2.5	8.0	150
1SMA5926BT3G	826B	10.45	11	11.55	34.1	5.5	550	0.25	0.5	8.4	136
1SMA5927BT3G	827B	11.4	12	12.6	31.2	6.5	550	0.25	0.5	9.1	125
1SMA5928BT3G	828B	12.35	13	13.65	28.8	7.0	550	0.25	0.5	9.9	115
1SMA5929BT3G	829B	14.25	15	15.75	25	9.0	600	0.25	0.5	11.4	100
1SMA5930BT3G	830B	15.2	16	16.8	23.4	10	600	0.25	0.5	12.2	94
1SMA5931BT3G	831B	17.1	18	18.9	20.8	12	650	0.25	0.5	13.7	83
1SMA5932BT3G	832B	19	20	21	18.7	14	650	0.25	0.5	15.2	75
1SMA5933BT3G	833B	20.9	22	23.1	17	17.5	650	0.25	0.5	16.7	68
1SMA5934BT3G	834B	22.8	24	25.2	15.6	19	700	0.25	0.5	18.2	63
1SMA5935BT3G	835B	25.65	27	28.35	13.9	23	700	0.25	0.5	20.6	56
1SMA5936BT3G	836B	28.5	30	31.5	12.5	26	750	0.25	0.5	22.8	50
1SMA5937BT3G	837B	31.35	33	34.65	11.4	33	800	0.25	0.5	25.1	45
1SMA5938BT3G	838B	34.2	36	37.8	10.4	38	850	0.25	0.5	27.4	42
1SMA5939BT3G	839B	37.05	39	40.95	9.6	45	900	0.25	0.5	29.7	38
1SMA5940BT3G	840B	40.85	43	45.15	8.7	53	950	0.25	0.5	32.7	35
1SMA5941BT3G	841B	44.65	47	49.35	8.0	67	1000	0.25	0.5	35.8	32
1SMA5942BT3G	842B	48.45	51	53.55	7.3	70	1100	0.25	0.5	38.8	29
1SMA5943BT3G	843B	53.2	56	58.8	6.7	86	1300	0.25	0.5	42.6	27
1SMA5944BT3G	844B	58.9	62	65.1	6.0	100	1500	0.25	0.5	47.1	24
1SMA5945BT3G	845B	64.6	68	71.4	5.5	120	1700	0.25	0.5	51.7	22

3. Tolerance and Voltage Regulation Designation – The type number listed indicates a tolerance of  $\pm 5\%$ .

4.  $V_Z$  limits are to be guaranteed at thermal equilibrium.

\* Include SZ-prefix devices where applicable.

# 1SMA59xxBT3G Series, SZ1SMA59xxBT3G Series

## RATING AND TYPICAL CHARACTERISTIC CURVES ( $T_A = 25^\circ\text{C}$ )

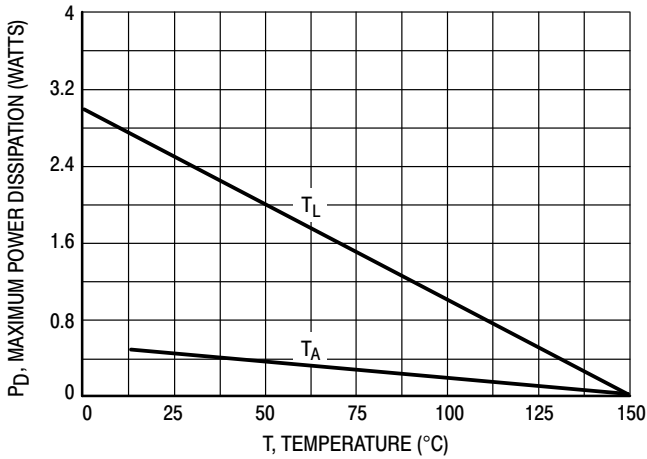

Figure 1. Steady State Power Derating

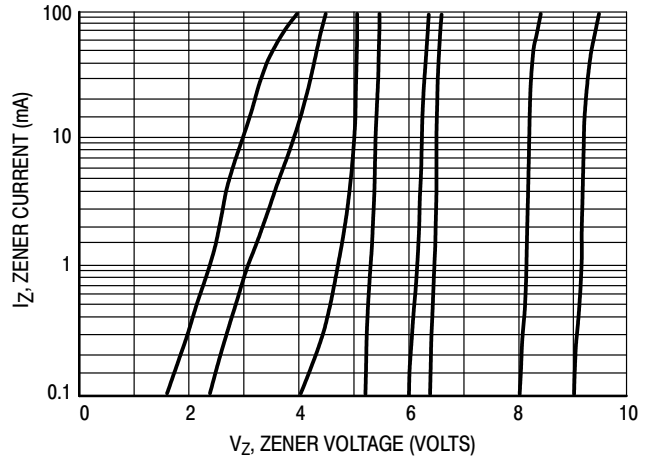

Figure 2.  $V_Z$  - 3.3 thru 10 Volts

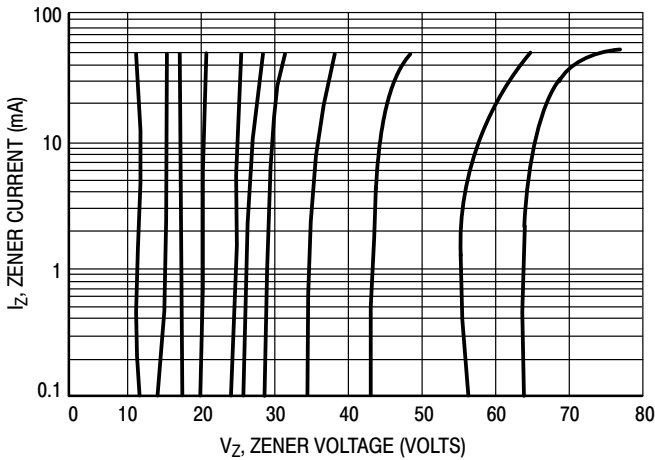

Figure 3.  $V_Z = 12$  thru 68 Volts

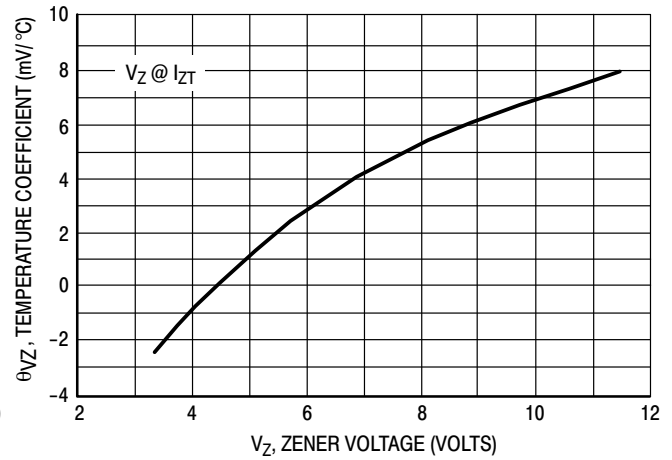

Figure 4. Zener Voltage - 3.3 to 12 Volts

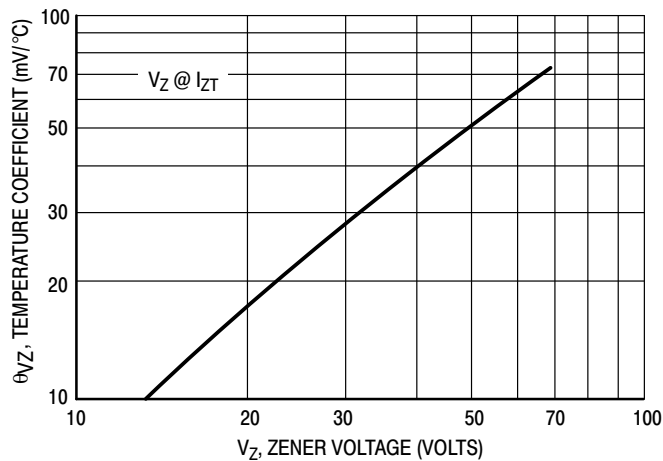

Figure 5. Zener Voltage - 12 to 68 Volts

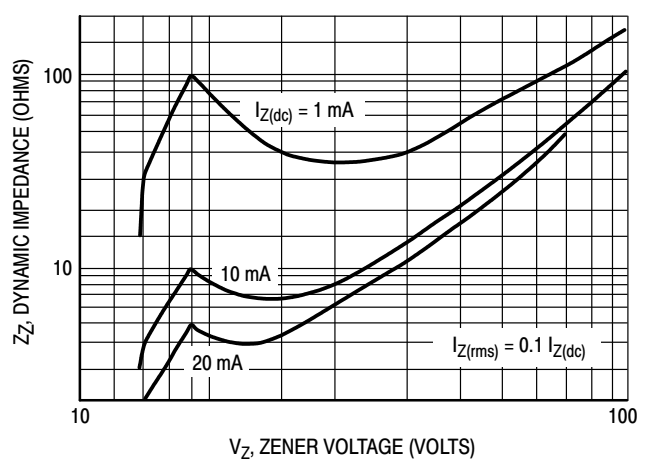

Figure 6. Effect of Zener Voltage

# 1SMA59xxBT3G Series, SZ1SMA59xxBT3G Series

## RATING AND TYPICAL CHARACTERISTIC CURVES ( $T_A = 25^\circ\text{C}$ )

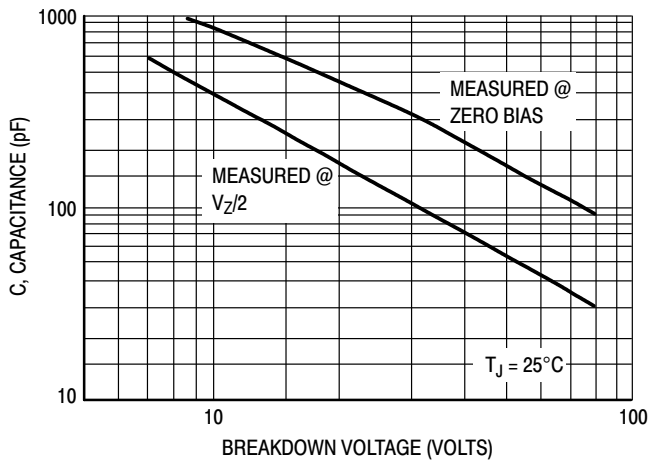

Figure 7. Capacitance Curve

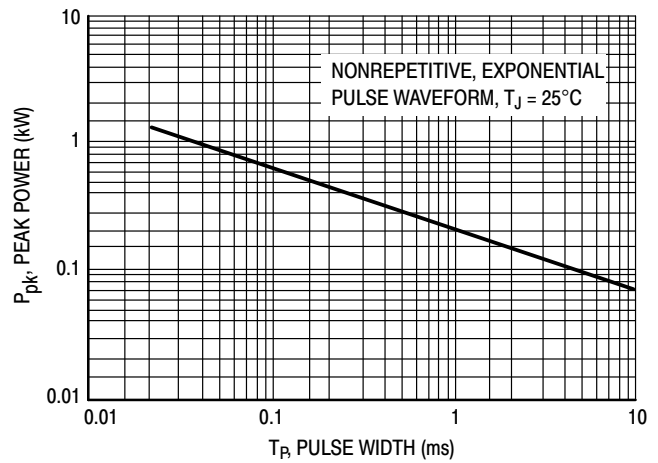

Figure 8. Typical Pulse Rating Curve

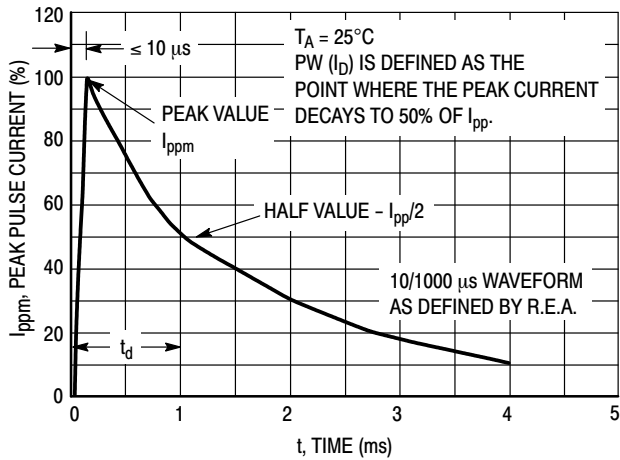

Figure 9. Pulse Waveform

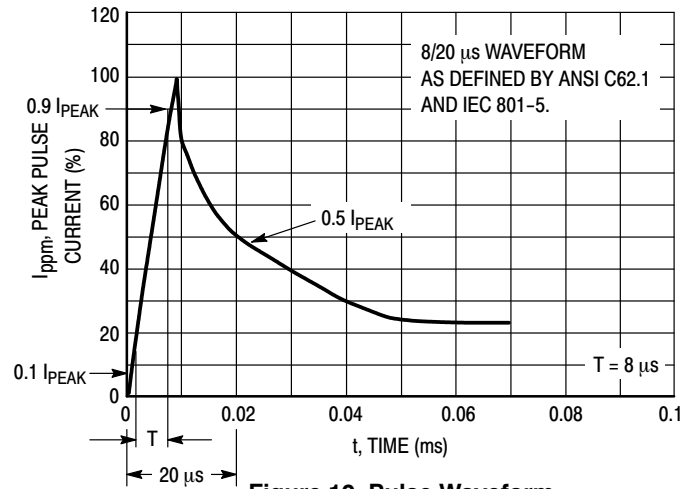
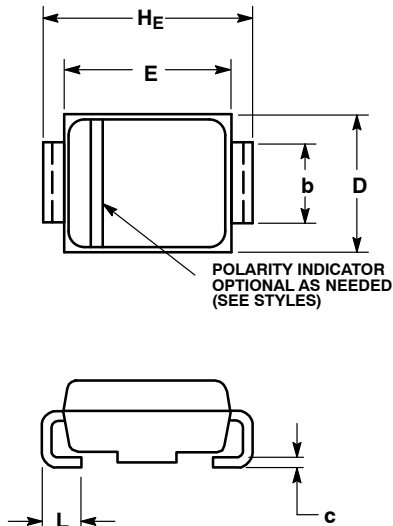

Figure 10. Pulse Waveform

# 1SMA59xxBT3G Series, SZ1SMA59xxBT3G Series

## PACKAGE DIMENSIONS

### SMA CASE 403D-02 ISSUE F



- NOTES:
1. DIMENSIONING AND TOLERANCING PER ANSI Y14.5M, 1982.
  2. CONTROLLING DIMENSION: INCH.
  3. 403D-01 OBSOLETE, NEW STANDARD IS 403D-02.

DIM	MILLIMETERS			INCHES		
	MIN	NOM	MAX	MIN	NOM	MAX
A	1.97	2.10	2.20	0.078	0.083	0.087
A1	0.05	0.10	0.15	0.002	0.004	0.006
b	1.27	1.45	1.63	0.050	0.057	0.064
c	0.15	0.28	0.41	0.006	0.011	0.016
D	2.29	2.60	2.92	0.090	0.103	0.115
E	4.06	4.32	4.57	0.160	0.170	0.180
HE	4.83	5.21	5.59	0.190	0.205	0.220
L	0.76	1.14	1.52	0.030	0.045	0.060

- STYLE 1:  
PIN 1. CATHODE (POLARITY BAND)  
2. ANODE

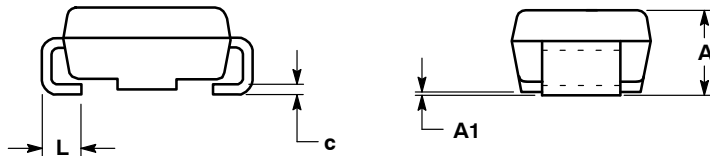

### SOLDERING FOOTPRINT\*

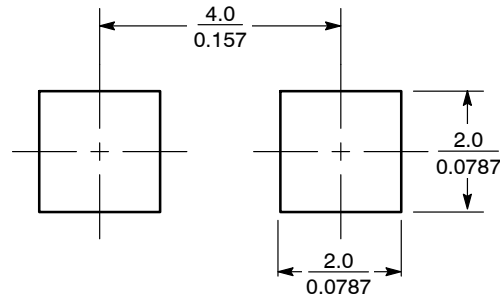

SCALE 8:1  $\left(\frac{\text{mm}}{\text{inches}}\right)$

\*For additional information on our Pb-Free strategy and soldering details, please download the ON Semiconductor Soldering and Mounting Techniques Reference Manual, SOLDERRM/D.

ON Semiconductor and are registered trademarks of Semiconductor Components Industries, LLC (SCILLC). SCILLC reserves the right to make changes without further notice to any products herein. SCILLC makes no warranty, representation or guarantee regarding the suitability of its products for any particular purpose, nor does SCILLC assume any liability arising out of the application or use of any product or circuit, and specifically disclaims any and all liability, including without limitation special, consequential or incidental damages. "Typical" parameters which may be provided in SCILLC data sheets and/or specifications can and do vary in different applications and actual performance may vary over time. All operating parameters, including "Typicals" must be validated for each customer application by customer's technical experts. SCILLC does not convey any license under its patent rights nor the rights of others. SCILLC products are not designed, intended, or authorized for use as components in systems intended for surgical implant into the body, or other applications intended to support or sustain life, or for any other application in which the failure of the SCILLC product could create a situation where personal injury or death may occur. Should Buyer purchase or use SCILLC products for any such unintended or unauthorized application, Buyer shall indemnify and hold SCILLC and its officers, employees, subsidiaries, affiliates, and distributors harmless against all claims, costs, damages, and expenses, and reasonable attorney fees arising out of, directly or indirectly, any claim of personal injury or death associated with such unintended or unauthorized use, even if such claim alleges that SCILLC was negligent regarding the design or manufacture of the part. SCILLC is an Equal Opportunity/Affirmative Action Employer. This literature is subject to all applicable copyright laws and is not for resale in any manner.

### PUBLICATION ORDERING INFORMATION

**LITERATURE FULFILLMENT:**  
Literature Distribution Center for ON Semiconductor  
P.O. Box 5163, Denver, Colorado 80217 USA  
**Phone:** 303-675-2175 or 800-344-3860 Toll Free USA/Canada  
**Fax:** 303-675-2176 or 800-344-3867 Toll Free USA/Canada  
**Email:** orderlit@onsemi.com

**N. American Technical Support:** 800-282-9855 Toll Free  
USA/Canada  
**Europe, Middle East and Africa Technical Support:**  
Phone: 421 33 790 2910  
**Japan Customer Focus Center**  
Phone: 81-3-5817-1050

**ON Semiconductor Website:** [www.onsemi.com](http://www.onsemi.com)  
**Order Literature:** <http://www.onsemi.com/orderlit>  
For additional information, please contact your local  
Sales Representative

1SMA5913BT3/D