

## FEATURES

- Automatically restarts microprocessor after power failure
- Maintains reset for 350 ms after  $V_{CC}$  returns to an in-tolerance condition
- Reduces need for discrete components
- Precision temperature-compensated voltage reference and voltage sensor
- Low-cost TO-92 package or surface mount 8-pin SOIC packages available
- Internal 5 k $\Omega$  pullup resistor
- Compatible with Motorola 68XXX series and HC16 Microprocessors
- Pin function compatible with the Motorola MC33064, MC34064, MC33164, and MC34164
- Operating temperature of -40°C to +85°C

## PIN ASSIGNMENT

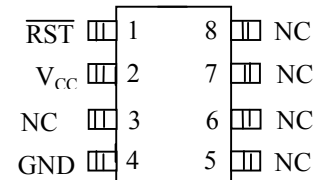
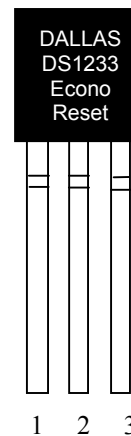

DS1233M 8-Pin SOIC  
(150mil)  
See Mech. Drawings  
Section on Website

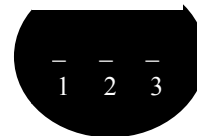

BOTTOM VIEW  
TO-92 PACKAGE  
See Mech.  
Drawings Section  
On Website

## PIN DESCRIPTIONS

### TO-92

- |                    |                           |
|--------------------|---------------------------|
| 1 $\overline{RST}$ | - Active Low Reset Output |
| 2 $V_{CC}$         | - Power Supply            |
| 3 GND              | - Ground                  |

### 8-Pin SOIC

- |                  |                           |
|------------------|---------------------------|
| $\overline{RST}$ | - Active Low Reset Output |
| $V_{CC}$         | - Power Supply            |
| NC               | - No Connect              |
| GND              | - Ground                  |

## DESCRIPTION

The DS1233M EconoReset uses a precision temperature-compensated reference and comparator circuit to monitor the status of the power supply ( $V_{CC}$ ). When an out-of-tolerance condition is detected, an internal power-fail signal is generated which forces reset to the active (low) state. When  $V_{CC}$  returns to an in-tolerance condition, the reset signal is kept in the active state for approximately 350 ms to allow the power supply and processor to stabilize.

## OPERATION - POWER MONITOR

The DS1233M provides the functions of detecting out-of-tolerance power supply conditions and warning a processor-based system of impending power failure. When  $V_{CC}$  is detected as out-of-tolerance, as defined by the tolerance of the part selected, the  $\overline{RST}$  signal is asserted. On power-up,  $\overline{RST}$  is kept active for approximately 350 ms after the power supply has reached the selected tolerance. This allows the power supply and microprocessor to stabilize before  $\overline{RST}$  is released.

### BLOCK DIAGRAM Figure 1

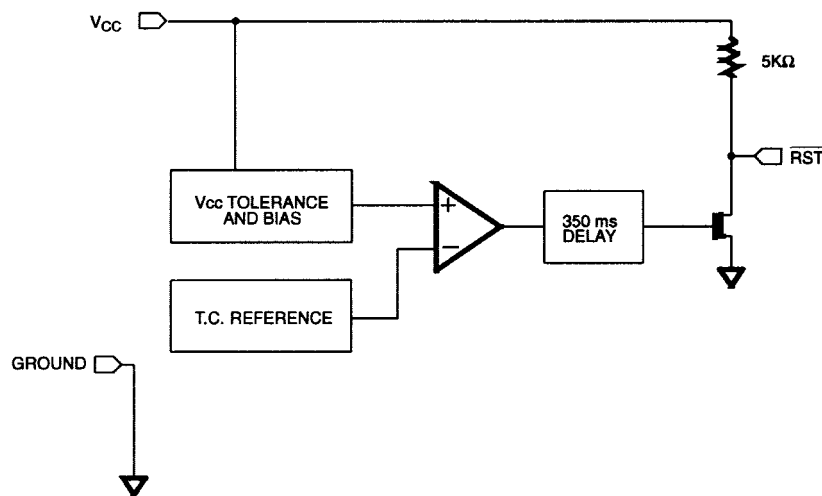

### APPLICATION EXAMPLE Figure 2

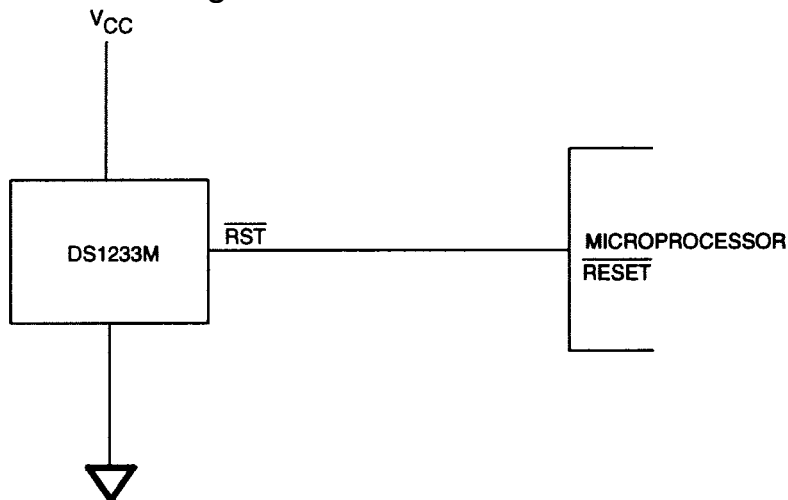

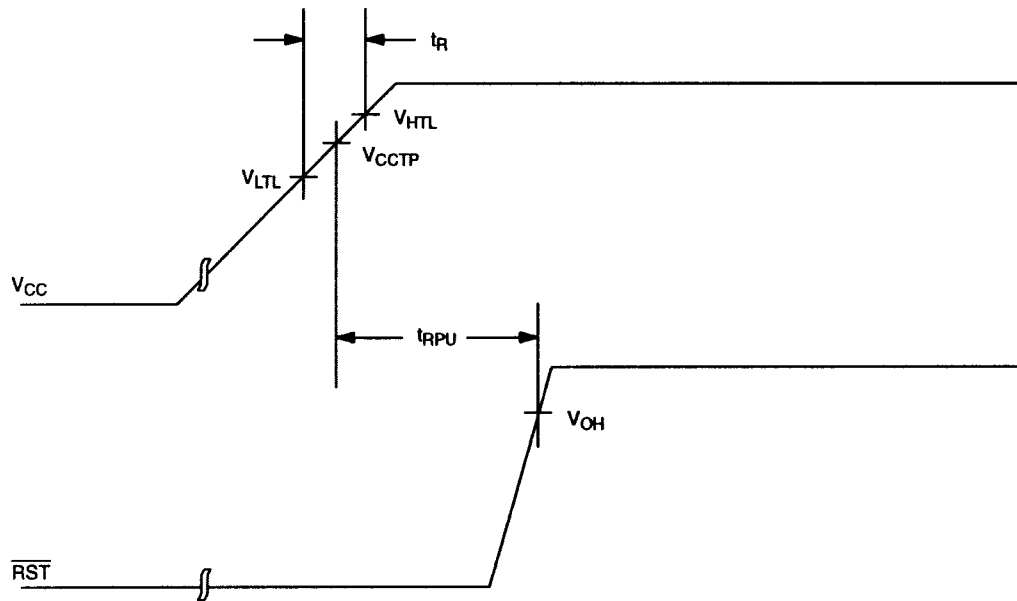
**TIMING DIAGRAM: POWER-UP** Figure 3**VOLTAGE TRIP LEVELS**

PARAMETER	SYMBOL	MIN	TYP	MAX	UNITS	NOTES
Voltage High Trip Level	$V_{HTL}$			4.75	V	DS1233M-5, DS1233M-55
Voltage Low Trip Level	$V_{LTL}$			4.00	V	DS1233M-5, DS1233M-55
Voltage High Trip Level	$V_{HTL}$			3.14	V	DS1233M-3
Voltage Low Trip Level	$V_{LTL}$			2.48	V	DS1233M-3

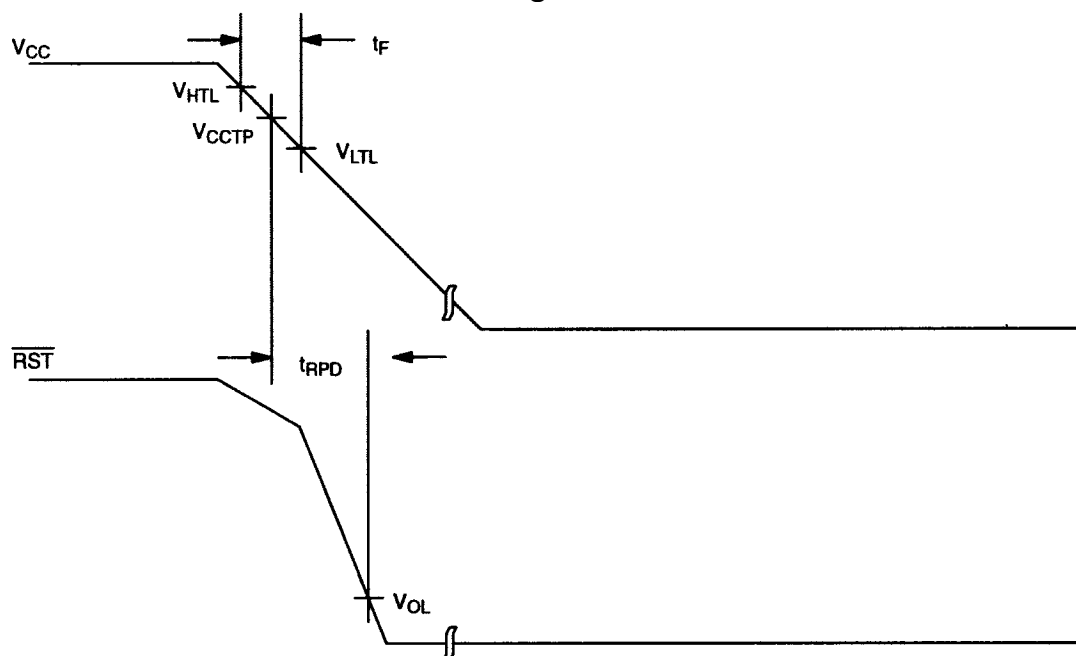
**TIMING DIAGRAM: POWER-DOWN** Figure 4

**ABSOLUTE MAXIMUM RATINGS\***

Voltage on $V_{CC}$ Pin Relative to Ground	-0.5V to +7.0V
Voltage on I/O Relative to Ground	-0.5V to $V_{CC} + 0.5V$
Operating Temperature	-40°C to +85°C
Storage Temperature	-55°C to +125°C
Soldering Temperature	260°C for 10 seconds

\* This is a stress rating only and functional operation of the device at these or any other conditions above those indicated in the operation sections of this specification is not implied. Exposure to absolute maximum rating conditions for extended periods of time may affect reliability.

**RECOMMENDED DC OPERATING CONDITIONS** (-40°C to +85°C)

PARAMETER	SYMBOL	MIN	TYP	MAX	UNITS	NOTES
Supply Voltage	$V_{CC}$	1.2		5.5	V	1

**DC ELECTRICAL CHARACTERISTICS** (-40°C to +85°C;  $V_{CC} = 1.2V$  to 5.5V)

PARAMETER	SYMBOL	MIN	TYP	MAX	UNITS	NOTES
Output Voltage @ -500 $\mu A$	$V_{OH}$	$V_{CC}-0.5V$	$V_{CC}-0.1V$		V	1
Output Current @ 0.4V	$I_{OL}$	+8			mA	2,3
Operating Current	$I_{CC}$			50	$\mu A$	4
$V_{CC}$ Trip Point (DS1233M-5)	$V_{CCTP}$	4.25	4.375	4.49	V	1
$V_{CC}$ Trip Point (DS1233M-55)	$V_{CCTP}$	4.5	4.625	4.75	V	1
$V_{CC}$ Trip Point (DS1233M-3)	$V_{CCTP}$	2.64	2.72	2.8	V	1
Output Capacitance	$C_{OUT}$			10	pF	
Internal Pullup Resistor	$R_P$	3.75	5	6.50	k $\Omega$	

**AC ELECTRICAL CHARACTERISTICS** (-40°C to +85°C;  $V_{CC} = 1.2V$  to 5.5V)

PARAMETER	SYMBOL	MIN	TYP	MAX	UNITS	NOTES
Reset Active Time	$t_{RST}$	200	350	500	ms	
$V_{CC}$ Detect to $\overline{RST}$	$t_{RPD}$		2	10	$\mu s$	
$V_{CC}$ Slew Rate ( $V_{HTL} - V_{LTL}$ )	$t_F$	300			$\mu s$	
$V_{CC}$ Slew Rate ( $V_{LTL} - V_{HTL}$ )	$t_R$	0			ns	
$V_{CC}$ Detect to RST	$t_{RPU}$	200	350	500	ms	5

**NOTES:**

1. All voltages are referenced to ground.
2. Measured with  $V_{CC} \geq 2.7V$ .
3. A 1 k $\Omega$  external resistor may be required in some applications for proper operation of the microprocessor reset control circuit.
4. Measured with outputs open.
5.  $t_R = 5 \mu s$ .