

Ultra-Low Power

- 160 μ A/MHz active current from 1.8–3.6 V @ 25 MHz
- 10 nA sleep current with data retention; BOD disabled
- 50 nA sleep current with data retention; BOD enabled
- 300 nA sleep current with smaRTClock (internal oscillator)
- 600 nA sleep current with smaRTClock (external crystal)
- 2 μ s wake up from sleep
- 1.5 μ s analog settling time

Supply Voltage: 0.9 to 3.6 V

- One-cell mode supports 0.9–3.6 V operation; bypass feature automatically shuts off the dc-dc converter when not needed
- Two-cell mode supports 1.8–3.6 V operation
- Built-in dc-dc converter with 1.8–3.3 V output (65 mW max) for use in one-cell mode; can supply external devices

12-Bit Analog to Digital Converter

- Up to 75 ksp/s 12-bit mode or 300 ksp/s 10-bit mode
- Up to 15 external inputs
- External pin or internal VREF (no external capacitor required)
- On-chip PGA allows measuring voltages up to twice the reference voltage
- Autonomous Burst Mode with 16-bit automatic averaging accumulator
- Built-in temperature sensor

Two Comparators

- Programmable hysteresis and response time
- Configurable as interrupt or reset source
- Low current (400 nA typical)
- Up to 15 Capacitive Touch Sense inputs

Internal 6-Bit Current Reference

- Up to \pm 500 μ A; source and sink capability
- Enhanced resolution via PWM interpolation

Development Kit: C8051F912DK

High-Speed 8051 μ C Core

- Pipe-lined instruction architecture; executes 70% of instructions in 1 or 2 system clocks
- 25 MIPS peak throughput with 25 MHz clock
- Expanded interrupt handler

Memory

- 768 bytes internal data RAM (256 + 512)
- 8 kB Flash; In-system programmable; Full read/write/erase functionality over the entire supply range

Digital Peripherals

- 16 port I/O; All 5 V tolerant with programmable drive strength
- Hardware enhanced UART, 2 SPI and SMBus™ serial ports available concurrently
- Low power 32-bit smaRTClock operates down to 0.9 V
- Four general purpose 16-bit counter/timers
- 16-bit programmable counter array (PCA) with six capture/compare modules and watchdog timer

Clock Sources

- Precision internal oscillators: 24.5 MHz with \pm 2% accuracy supports UART operation; spread-spectrum mode for reduced EMI
- Low power internal oscillator: 20 MHz
- External oscillator: Crystal, RC, C, CMOS clock
- smaRTClock oscillator: 32.768 kHz crystal or 16.4 kHz LFO
- Can switch between clock sources on-the-fly; useful in power saving modes

On-Chip Debug

- On-chip debug circuitry facilitates full speed, non-intrusive in-system debug (no emulator required)
- Provides 4 breakpoints, single stepping

Package Options

- 24-pin QFN (4x4 mm), RoHS compliant
- 24-pin QSOP (easy to hand solder), RoHS compliant

Temperature Range: –40 to +85 °C

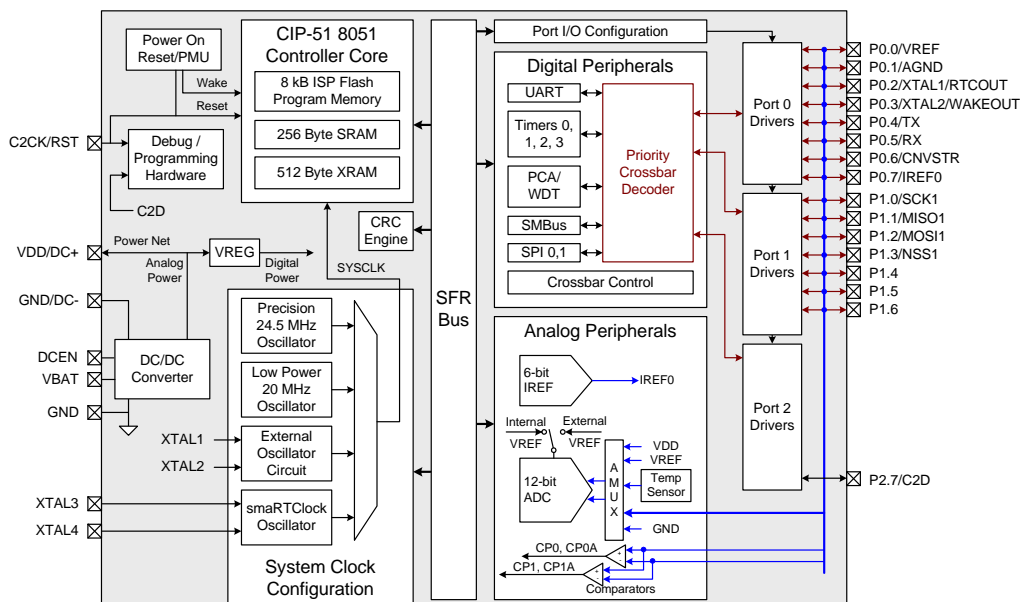

Selected Electrical Specifications

(At 25 C°)

Parameter	Conditions	Min	Typ	Max	Units
Supply Input Voltage two-cell mode one-cell mode	DC-DC converter disabled	1.8	—	3.6	V
	DC-DC converter enabled	0.9	—	3.6	V
Supply Current with CPU Active	VDD = 1.8–3.6 V Clock = 24.5 MHz (±2% internal precision oscillator)	—	160	—	µA/MHz
Supply Current (shutdown) (V _{BAT} = 1.8 V)	Sleep mode; BOD off	—	.010	—	µA
	Sleep mode; BOD on	—	.050	—	µA
	Sleep mode; smartClock running	—	.300	—	µA
Clock Frequency Range		DC	—	25	MHz
Wakeup Time	two-cell mode	—	2	—	µs
	one-cell mode	—	10	—	µs
Analog Settling Time		—	1.5	—	µs
Internal Oscillator					
Frequency	Precision oscillator	24	24.5	25	MHz
	Low power oscillator	18	20	22	MHz
A/D Converter					
Resolution				12/10	bits
Throughput Rate				75/300	ksps

Package Information: 24-Pin QFN

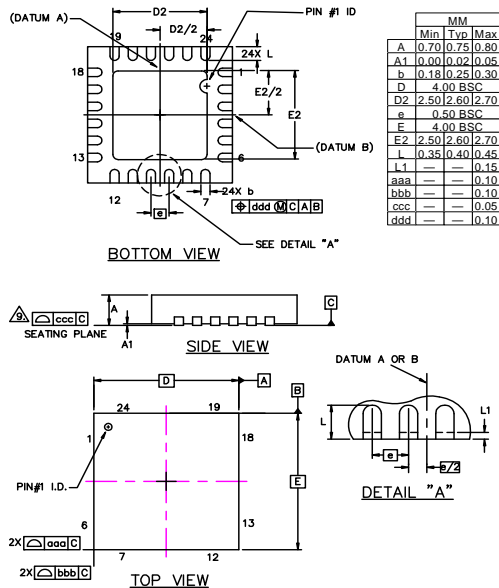

Product Family

Part Number	Package	Package Size (mm)	ADC	Flash (kB)	RAM (bytes)	RTC sleep (nA)	BOD Disableable
C8051F912-GM	24p QFN	4x4	12-bit	16	768	300	Yes
C8051F912-GU	24p QSOP	9x6	12-bit	16	768	300	Yes
C8051F911-GM	24p QFN	4x4	10-bit	16	768	600	No
C8051F911-GU	24p QSOP	9x6	10-bit	16	768	600	No
C8051F902-GM	24p QFN	4x4	12-bit	8	768	300	Yes
C8051F902-GU	24p QSOP	9x6	12-bit	8	768	300	Yes
C8051F901-GM	24p QFN	4x4	10-bit	8	768	600	No
C8051F901-GU	24p QSOP	9x6	10-bit	8	768	600	No