

Load Switch with Level-Shift

PRODUCT SUMMARY		
V_{DS2} (V)	$r_{DS(on)}$ (Ω)	I_D (A)
2.5 to 12	0.105 @ $V_{IN} = 4.5$ V	± 2.5
	0.125 @ $V_{IN} = 3.0$ V	± 2.1
	0.165 @ $V_{IN} = 2.5$ V	± 1.8



ESD Protected
3000 V
2.5-V Rated

FEATURES

- 105-m Ω Low $r_{DS(on)}$ TrenchFET™
- 2.5 to 12-V Input
- 1.5 to 8-V Logic Level Control
- Low Profile, Small Footprint TSOP-6 Package
- 3000-V ESD Protection On Input Switch, $V_{ON/OFF}$
- Adjustable Slew-Rate

DESCRIPTION

The Si3863DV includes a p- and n-channel MOSFET in a single TSOP-6 package. The low on-resistance p-channel TrenchFET® is tailored for use as a load switch. The n-channel, with an external resistor, can be used as a

level-shift to drive the p-channel load-switch. The n-channel MOSFET has internal ESD protection and can be driven by logic signals as low as 1.5-V. The Si3863DV operates on supply lines from 2.5 to 12-V, and can drive loads up to 2.5 A.

APPLICATION CIRCUITS

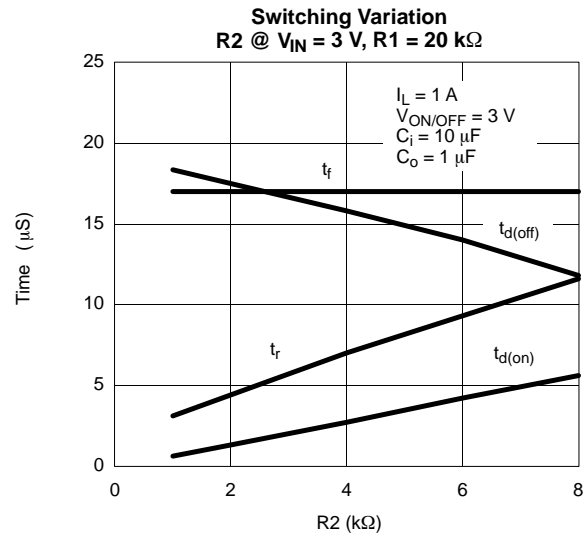
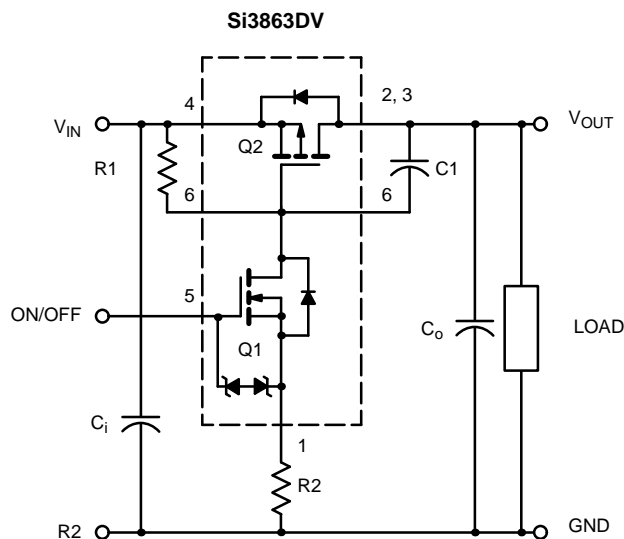

Note: For R2 switching variations with other $V_{IN}/R1$ combinations See Typical Characteristics

COMPONENTS

Component	Description	Typical Value
R1	Pull-Up Resistor	Typical 10 k Ω to 1 m Ω *
R2	Optional Slew-Rate Control	Typical 0 to 100 k Ω *
C1	Optional Slew-Rate Control	Typical 1000 pF

*Minimum R1 value should be at least 10 x R2 to ensure Q1 turn-on.

The Si3863DV is ideally suited for high-side load switching in portable applications. The integrated n-channel level-shift device saves space by reducing external components. The slew rate is set externally so that rise-times can be tailored to different load types.

FUNCTIONAL BLOCK DIAGRAM

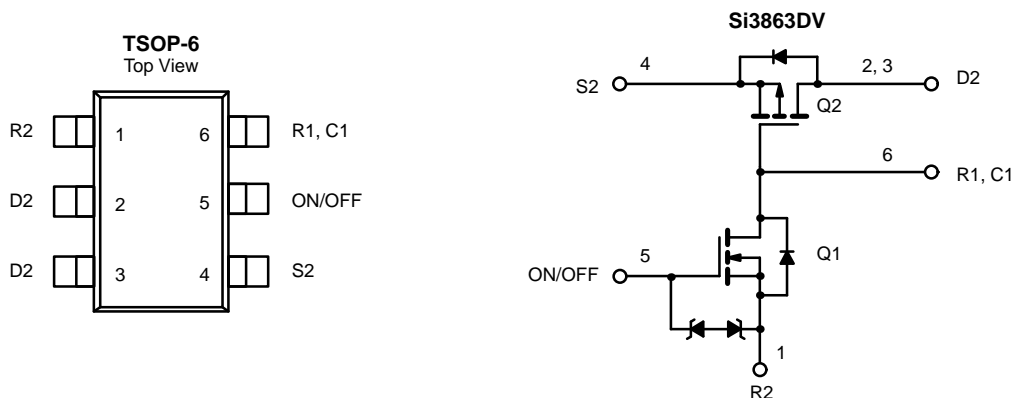

ABSOLUTE MAXIMUM RATINGS (T_A = 25 °C UNLESS OTHERWISE NOTED)

Parameter	Symbol	Limit	Unit
Input Voltage	V _{IN}	12	V
ON/OFF Voltage	V _{ON/OFF}	8	V
Load Current	Continuous ^{a, b}	±2.5	A
	Pulsed ^{b, c}	±5	
Continuous Intrinsic Diode Conduction ^a	I _S	-1	
Maximum Power Dissipation ^a	P _D	0.83	W
Operating Junction and Storage Temperature Range	T _J , T _{stg}	-55 to 150	°C
ESD Rating, MIL-STD-883D Human Body Model (100 pF, 1500 Ω)	ESD	3	kV

THERMAL RESISTANCE RATINGS

Parameter	Symbol	Typical	Maximum	Unit
Maximum Junction-to-Ambient (continuous current) ^a	R _{thJA}	120	150	°C/W
Maximum Junction-to-Foot (Q2)	R _{thJC}	35	50	

SPECIFICATIONS (T_J = 25 °C UNLESS OTHERWISE NOTED)

Parameter	Symbol	Test Condition	Min	Typ	Max	Unit
OFF Characteristics						
Reverse Leakage Current	I _{FL}	V _{IN} = 12 V, V _{ON/OFF} = 0 V			1	μA
Diode Forward Voltage	V _{SD}	I _S = -1 A		-0.75	-1	V
ON Characteristics						
Input Voltage Range	V _{IN}		2.5		12	V
On-Resistance (p-channel) @ 1 A	r _{DS(on)}	V _{ON/OFF} = 1.5 V I _D = 1 A	V _{IN} = 4.5 V	0.086	0.105	Ω
			V _{IN} = 3.0 V	0.105	0.125	
			V _{IN} = 2.5 V	0.135	0.165	
On-State (p-channel) Drain-Current	I _{D(on)}	V _{IN-OUT} ≤ 0.2 V, V _{IN} = 5 V, V _{ON/OFF} = 1.5 V	1			A
		V _{IN-OUT} ≤ 0.3 V, V _{IN} = 3 V, V _{ON/OFF} = 1.5 V	1			

Notes

- a. Surface Mounted on FR4 Board.
- b. V_{IN} = 12 V, V_{ON/OFF} = 8 V, T_A = 25 °C.
- c. Pulse test: pulse width ≤ 300 μs, duty cycle ≤ 2%.

TYPICAL CHARACTERISTICS (25°C UNLESS NOTED)

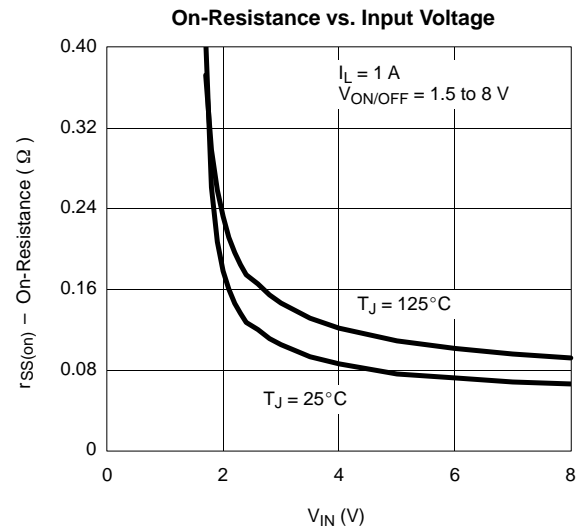
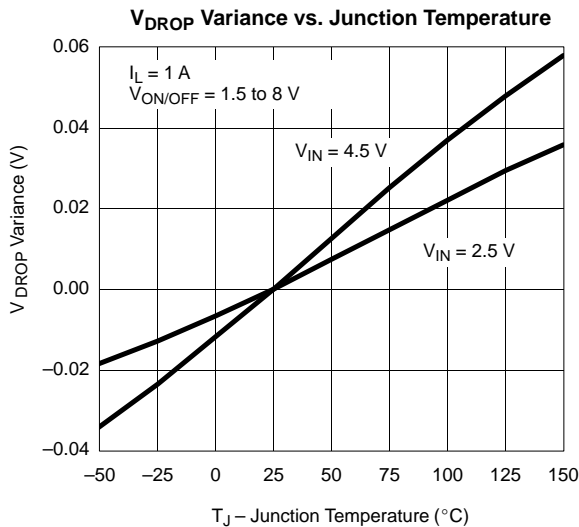
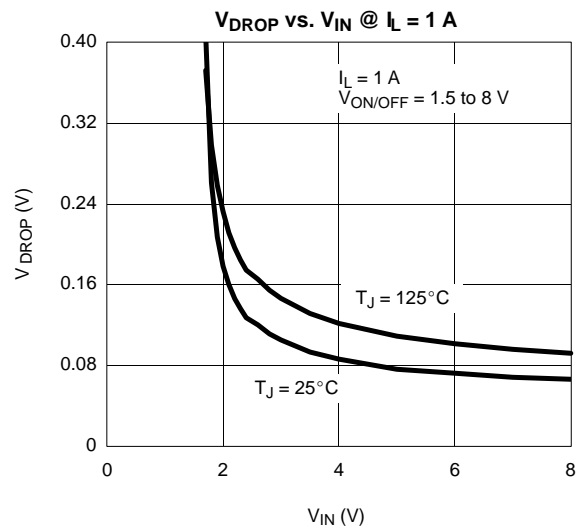
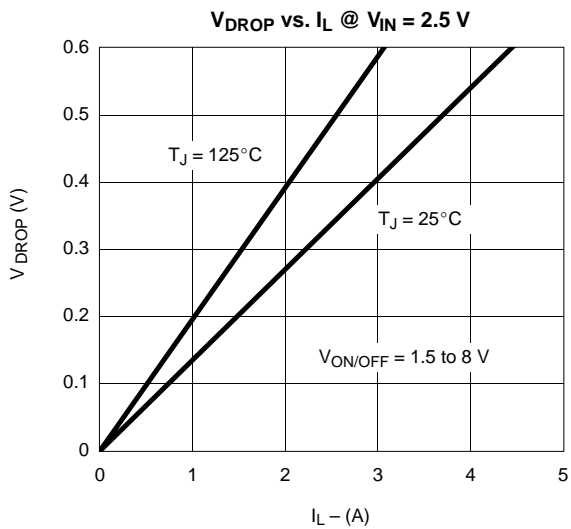
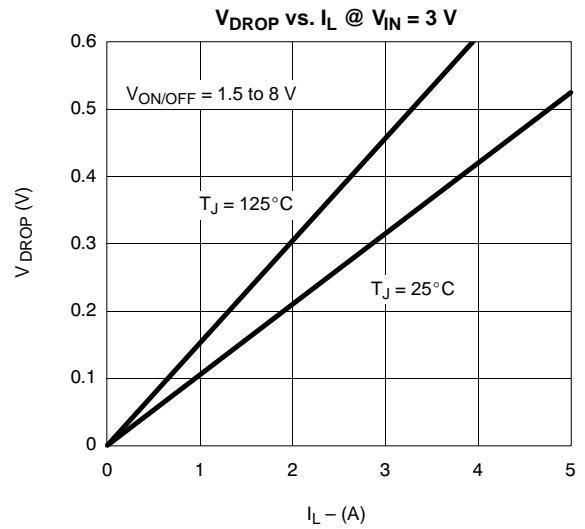
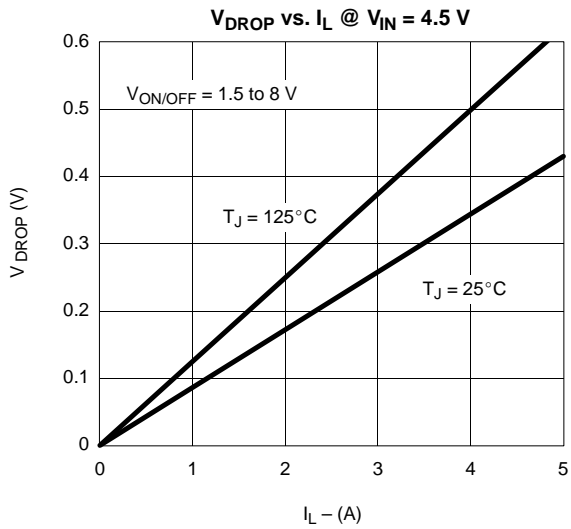



TYPICAL CHARACTERISTICS (25 °C UNLESS NOTED)

Normalized On-Resistance vs. Junction Temperature

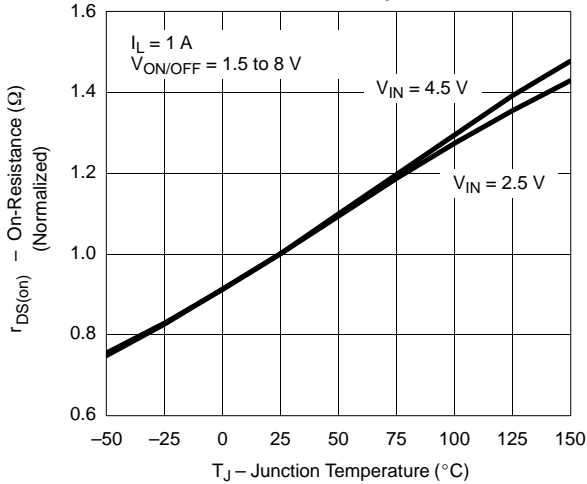

Switching Variation R2 @ V_IN = 4.5 V, R1 = 20 kΩ

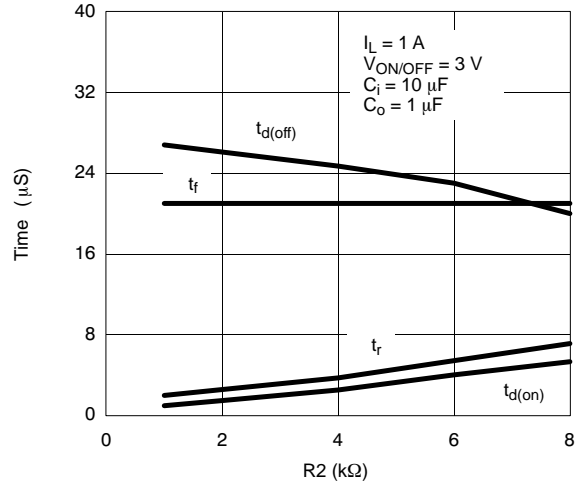

Switching Variation R2 @ V_IN = 3 V, R1 = 20 kΩ

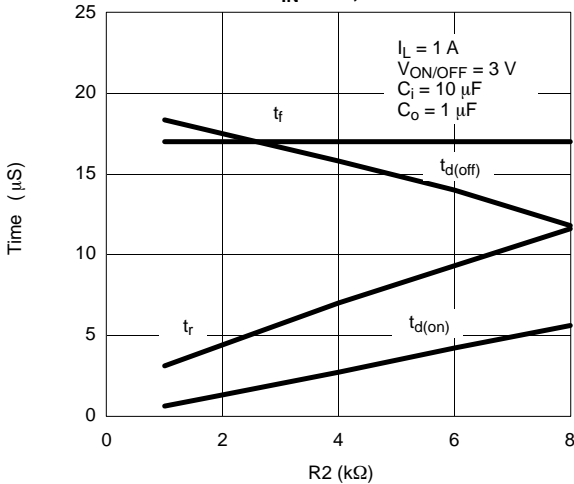

Switching Variation R2 @ V_IN = 2.5 V, R1 = 20 kΩ

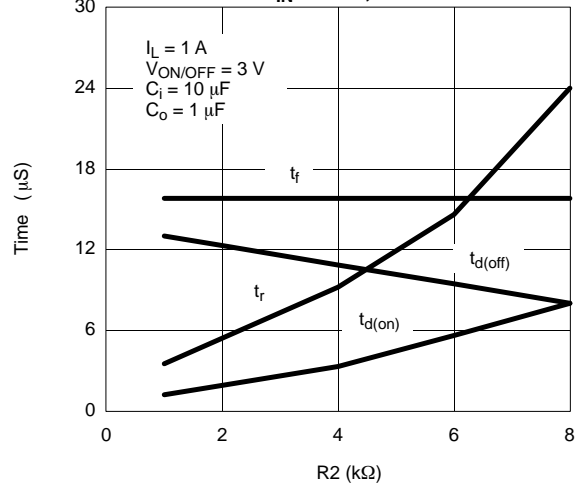

Switching Variation R2 @ V_IN = 4.5 V, R1 = 300 kΩ

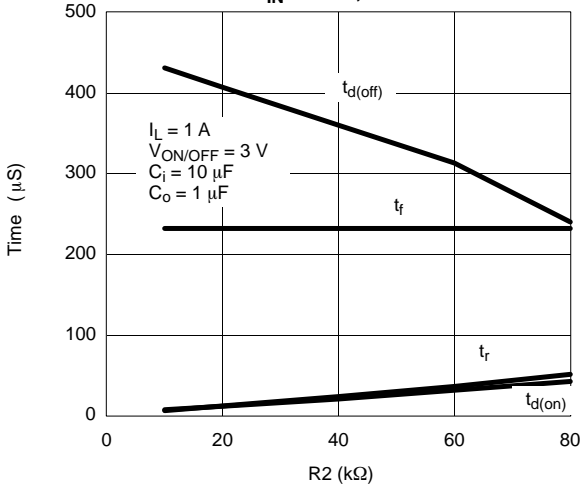

Switching Variation R2 @ V_IN = 3 V, R1 = 300 kΩ

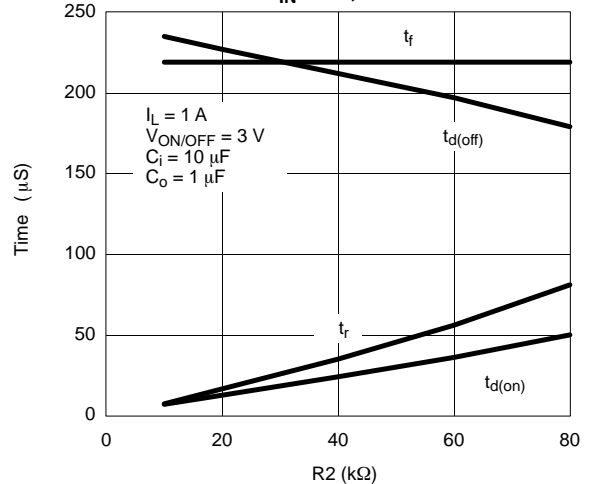

TYPICAL CHARACTERISTICS (25°C UNLESS NOTED)

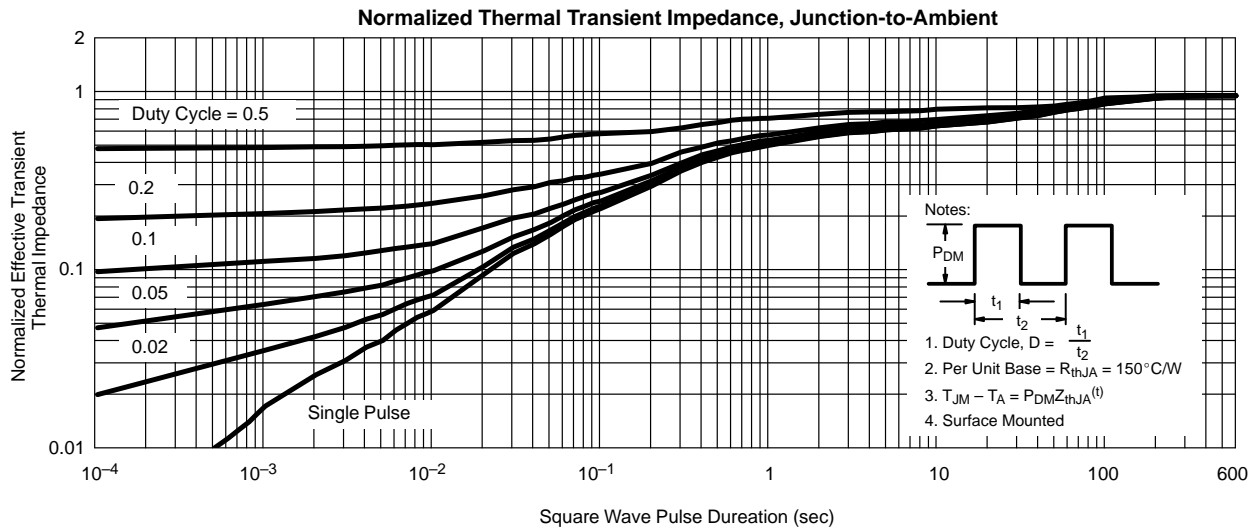
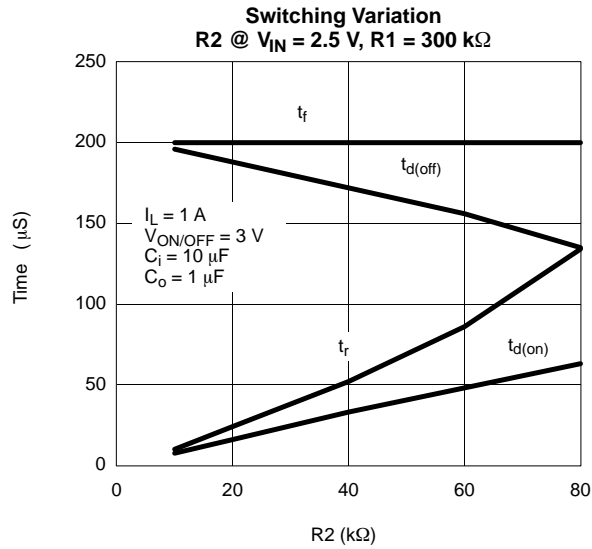



Notice

Specifications of the products displayed herein are subject to change without notice. Vishay Intertechnology, Inc., or anyone on its behalf, assumes no responsibility or liability for any errors or inaccuracies.

Information contained herein is intended to provide a product description only. No license, express or implied, by estoppel or otherwise, to any intellectual property rights is granted by this document. Except as provided in Vishay's terms and conditions of sale for such products, Vishay assumes no liability whatsoever, and disclaims any express or implied warranty, relating to sale and/or use of Vishay products including liability or warranties relating to fitness for a particular purpose, merchantability, or infringement of any patent, copyright, or other intellectual property right.

The products shown herein are not designed for use in medical, life-saving, or life-sustaining applications. Customers using or selling these products for use in such applications do so at their own risk and agree to fully indemnify Vishay for any damages resulting from such improper use or sale.