

NCP334, NCP335

2A Ultra-Small Controlled Load Switch with Auto-Discharge Path

The NCP334 and NCP335 are low Ron MOSFET controlled by external logic pin, allowing optimization of battery life, and portable device autonomy.

Indeed, due to a current consumption optimization with PMOS structure, leakage currents are eliminated by isolating connected IC's on the battery when not used.

Output discharge path is also embedded to eliminate residual voltages on the output rail in the NCP335.

Proposed in wide input voltage range from 1.2 V to 5.5 V, and a very small 0.96 x 0.96 mm WLCSP4, 0.5 mm pitch.

Features

- 1.2 V – 5.5 V Operating Range
- 47 mΩ P MOSFET at 3.3 V
- DC Current Up to 2 A
- Output Auto-discharge (NCP335)
- Active high EN pin
- WLCSP4 0.96 x 0.96 mm
- ESD Ratings: 4 kV Human Body Model, 2 kV CDM,
- 250 V Machine Model
- These are Pb-Free Devices

Typical Applications

- Mobile Phones
- Tablets
- Digital Cameras
- GPS
- Portable Devices



ON Semiconductor®

<http://onsemi.com>

MARKING DIAGRAM



WLCSP4
CASE 567FG

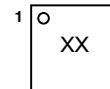

XX = Specific Device Code
A = Assembly Location
WL = Wafer Lot
YY = Year
WW = Work Week
G = Pb-Free Package

PIN DIAGRAM

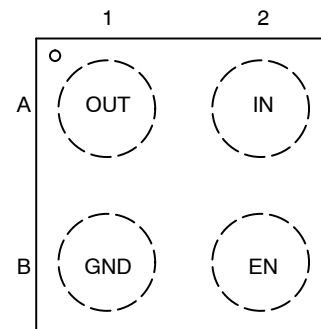

(Top View)

ORDERING INFORMATION

See detailed ordering and shipping information in the package dimensions section on page 9 of this data sheet.

NCP334, NCP335

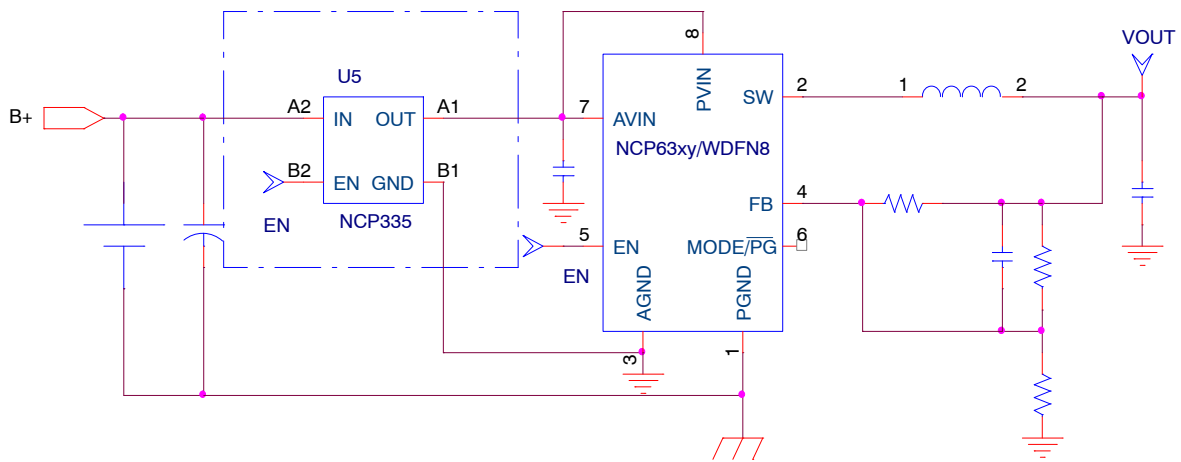

Figure 1. Typical Application Circuit

PIN FUNCTION DESCRIPTION

Pin Name	Pin Number	Type	Description
IN	A2	POWER	Load-switch input voltage; connect a 1 μ F or greater ceramic capacitor from IN to GND as close as possible to the IC.
GND	B1	POWER	Ground connection.
EN	B2	INPUT	Enable input, logic high turns on power switch.
OUT	A1	OUTPUT	Load-switch output; connect a 1 μ F ceramic capacitor from OUT to GND as close as possible to the IC is recommended.

BLOCK DIAGRAM

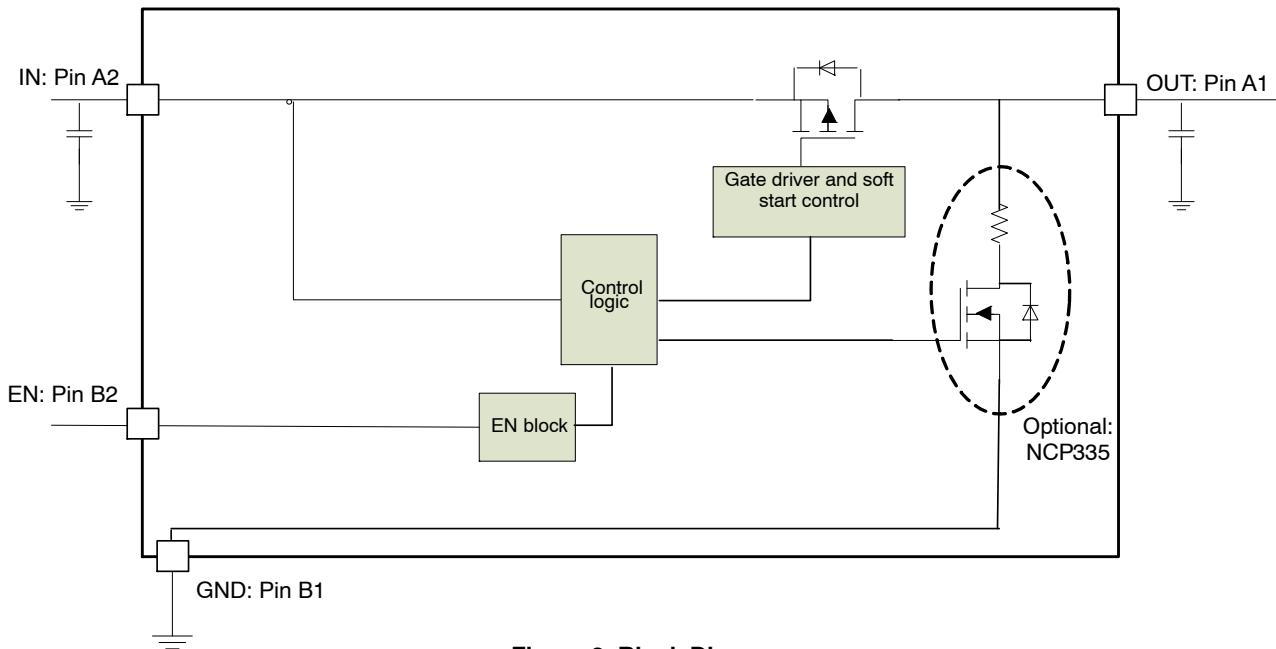

Figure 2. Block Diagram

NCP334, NCP335

MAXIMUM RATINGS

Rating	Symbol	Value	Unit
IN, OUT, EN, Pins	V_{EN}, V_{IN}, V_{OUT}	0.3 to + 7.0	V
From IN to OUT Pins: Input/Output	V_{IN}, V_{OUT}	0 to + 7.0	V
Maximum Junction Temperature	T_J	-40 to + 125	°C
Storage Temperature Range	T_{STG}	-40 to + 150	°C
Human Body Model (HBM) ESD Rating are (Notes 1 and 2)	ESD HBM	4000	V
Machine Model (MM) ESD Rating are (Notes 1 and 2)	ESD MM	250	V
Charge Device Model (CDM) ESD Rating are (Notes 1 and 2)	ESD CDM	2000	V
Latch-up protection (Note 3) – Pins IN, OUT, EN	LU	100	mA
Moisture Sensitivity (Note 4)	MSL	Level 1	

Stresses exceeding Maximum Ratings may damage the device. Maximum Ratings are stress ratings only. Functional operation above the Recommended Operating Conditions is not implied. Extended exposure to stresses above the Recommended Operating Conditions may affect device reliability.

1. According to JEDEC standard JESD22-A108.
2. This device series contains ESD protection and passes the following tests:
Human Body Model (HBM) ± 4.0 kV per JEDEC standard: JESD22-A114 for all pins.
Machine Model (MM) ± 250 V per JEDEC standard: JESD22-A115 for all pins.
Charge Device Model (CDM) ± 2.0 kV per JEDEC standard: JESD22-C101 for all pins.
3. Latch up Current Maximum Rating: ± 100 mA per JEDEC standard: JESD78 class II.
4. Moisture Sensitivity Level (MSL): 1 per IPC/JEDEC standard: J-STD-020.

OPERATING CONDITIONS

Symbol	Parameter	Conditions	Min	Typ	Max	Unit
V_{IN}	Operational Power Supply		1.2		5.5	V
V_{EN}	Enable Voltage		0		5.5	
T_A	Ambient Temperature Range		-40	25	+ 85	°C
C_{IN}	Decoupling input capacitor		1			μ F
C_{OUT}	Decoupling output capacitor		1			μ F
$R_{\theta JA}$	Thermal Resistance Junction to Air	WLCSP package (Note 5)		100		°C/W
I_{OUT}	Maximum DC current				2	A
P_D	Power Dissipation Rating (Note 6)	$T_A \leq 25$ °C	WLCSP package		0.5	W
		$T_A = 85$ °C	WLCSP package		0.2	W

5. The $R_{\theta JA}$ is dependent of the PCB heat dissipation and thermal via.
6. The maximum power dissipation (P_D) is given by the following formula:

$$P_D = \frac{T_{JMAX} - T_A}{R_{\theta JA}}$$

NCP334, NCP335

ELECTRICAL CHARACTERISTICS Min and Max Limits apply for T_A between -40°C to $+85^{\circ}\text{C}$ for V_{IN} between 1.2 V to 5.5 V (Unless otherwise noted). Typical values are referenced to $T_A = +25^{\circ}\text{C}$ and $V_{IN} = 4\text{ V}$ (Unless otherwise noted).

Symbol	Parameter	Conditions		Min	Typ	Max	Unit
POWER SWITCH							
$R_{DS(on)}$	Static drain-source on-state resistance	$V_{IN} = 5.5\text{ V}$	$T_A = 25^{\circ}\text{C}, I = 200\text{ mA}$ (Note 8)		38	40	$\text{m}\Omega$
		$V_{IN} = 4.2\text{ V}$	$T_A = 25^{\circ}\text{C}, I = 200\text{ mA}$		42	46	
		$V_{IN} = 3.3\text{ V}$	$T_A = 25^{\circ}\text{C}, I = 200\text{ mA}$		47	52	
		$V_{IN} = 1.8\text{ V}$	$T_A = 25^{\circ}\text{C}, I = 200\text{ mA}$		76	87	
			Full			100	
		$V_{IN} = 1.2\text{ V}$	$T_A = 25^{\circ}\text{C}, I = 200\text{ mA}$		211	420	
R_{DIS}	Output discharge path	EN = low	$V_{IN} = 3.3\text{ V}$, NCP335 only		65	110	Ω
T_R	Output rise time	$V_{IN} = 3.6\text{ V}$	$C_{LOAD} = 1\ \mu\text{F}$, $R_{LOAD} = 25\ \Omega$ (Note 7)		71		μs
T_F	Output fall time	$V_{IN} = 3.6\text{ V}$	$C_{LOAD} = 1\ \mu\text{F}$, $R_{LOAD} = 25\ \Omega$ (Note 7)		42		μs
T_{on}	Gate turn on	$V_{IN} = 3.6\text{ V}$	Gate turn on + Output rise time		116		μs
T_{en}	Enable time	$V_{IN} = 3.6\text{ V}$	From EN low to high to $V_{OUT} = 10\%$ of fully on		45		μs
V_{IH}	High-level input voltage			0.9			V
V_{IL}	Low-level input voltage					0.5	V
R_{EN}	Pull down resistor				5		$\text{M}\Omega$

QUIESCENT CURRENT

I_Q	Current consumption	$V_{IN} = 3.3\text{ V}$, EN = low, No load				1	μA
		$V_{IN} = 3.3\text{ V}$, EN = high, No load				1	μA

7. Parameters are guaranteed for C_{LOAD} and R_{LOAD} connected to the OUT pin with respect to the ground
 8. Guaranteed by design and characterization, not production tested.

TIMINGS

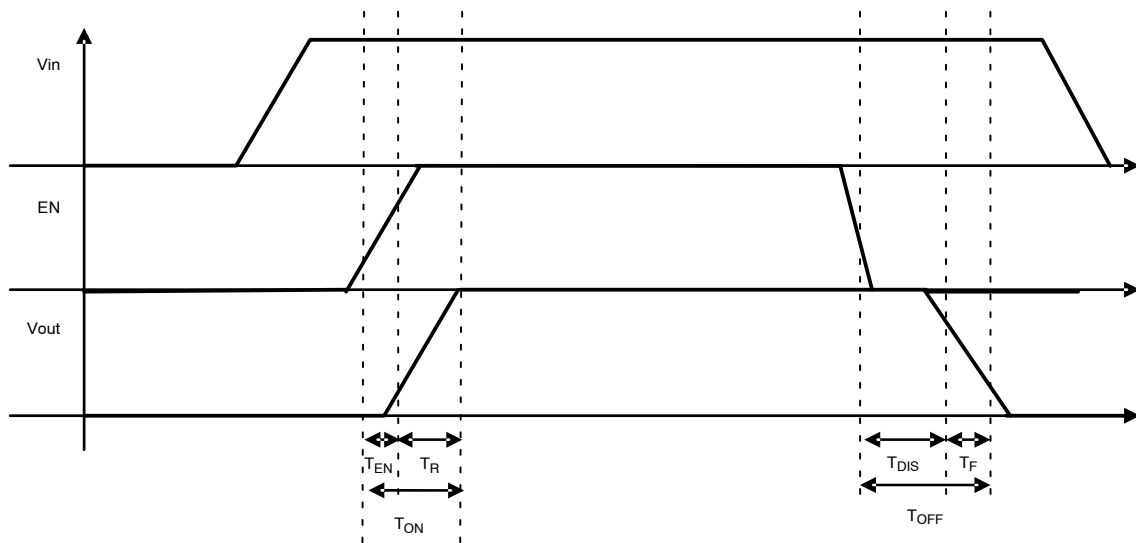

Figure 3. Enable, Rise and fall time

NCP334, NCP335

TYPICAL CHARACTERISTICS

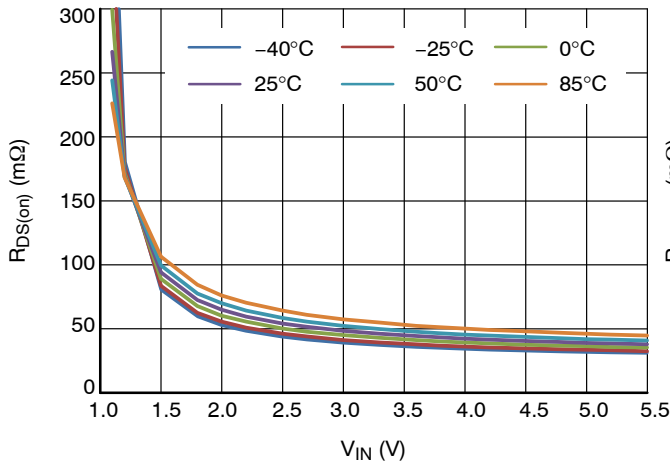

Figure 4. $R_{DS(on)}$ ($m\Omega$) vs. V_{IN} (V)

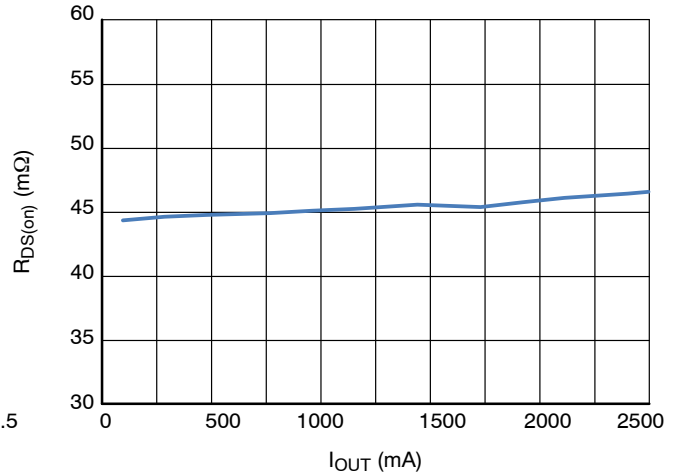

Figure 5. $R_{DS(on)}$ ($m\Omega$) vs. I_{OUT} (mA) at 3.6 V

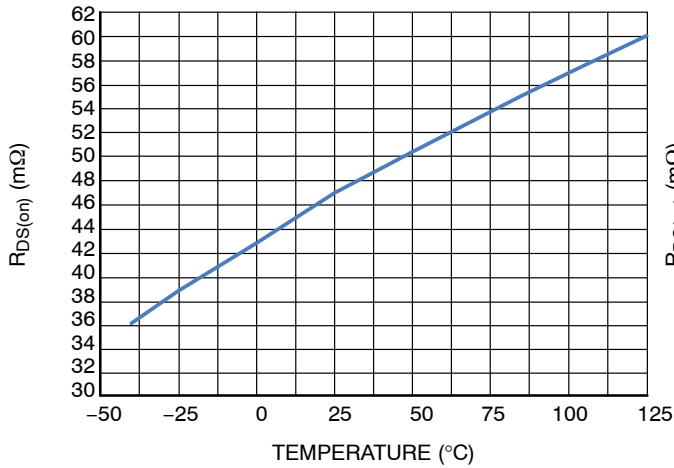

Figure 6. $R_{DS(on)}$ ($m\Omega$) vs. Temperature ($^{\circ}C$) at 3.3 V, I_{load} 100 mA

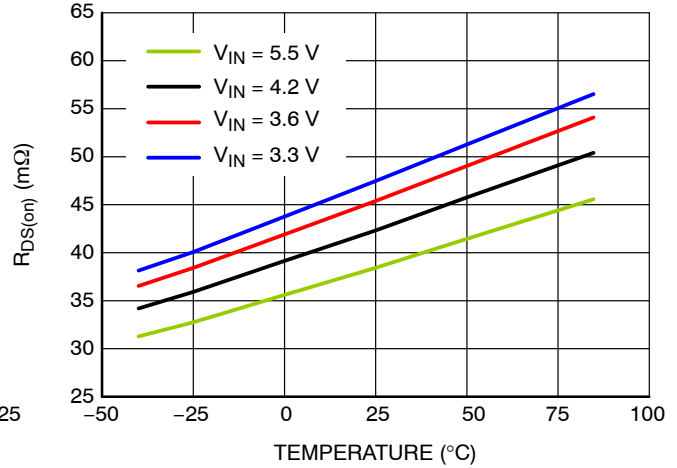

Figure 7. $R_{DS(on)}$ ($m\Omega$) vs. Temperature ($^{\circ}C$), I_{load} 2 A

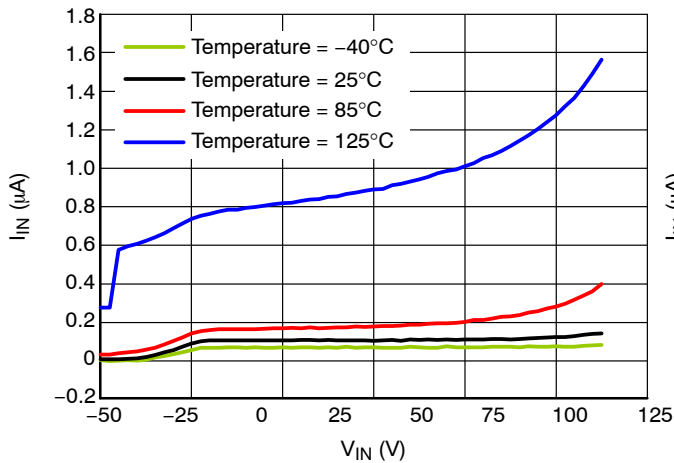

Figure 8. Standby Current (μA) versus V_{IN} (V), No Load

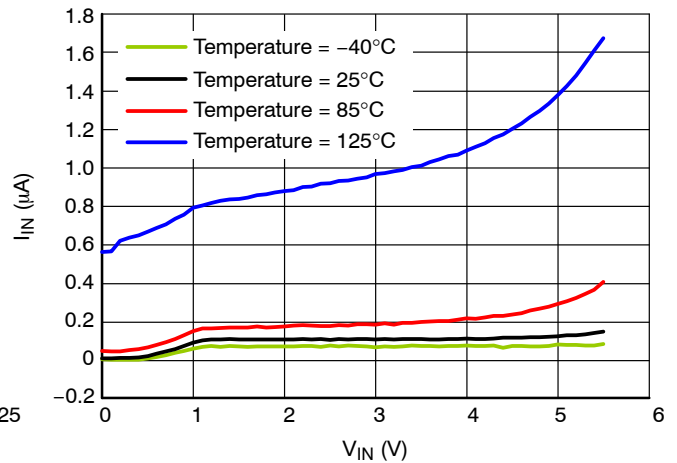

Figure 9. Standby Current (μA) versus V_{IN} (V), V_{out} Short to GND.

NCP334, NCP335

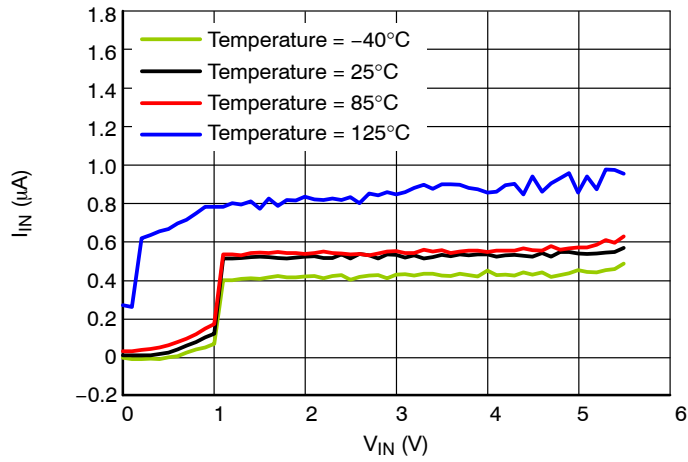

Figure 10. Quiescent Current (μA) versus V_{IN} (V), No load.

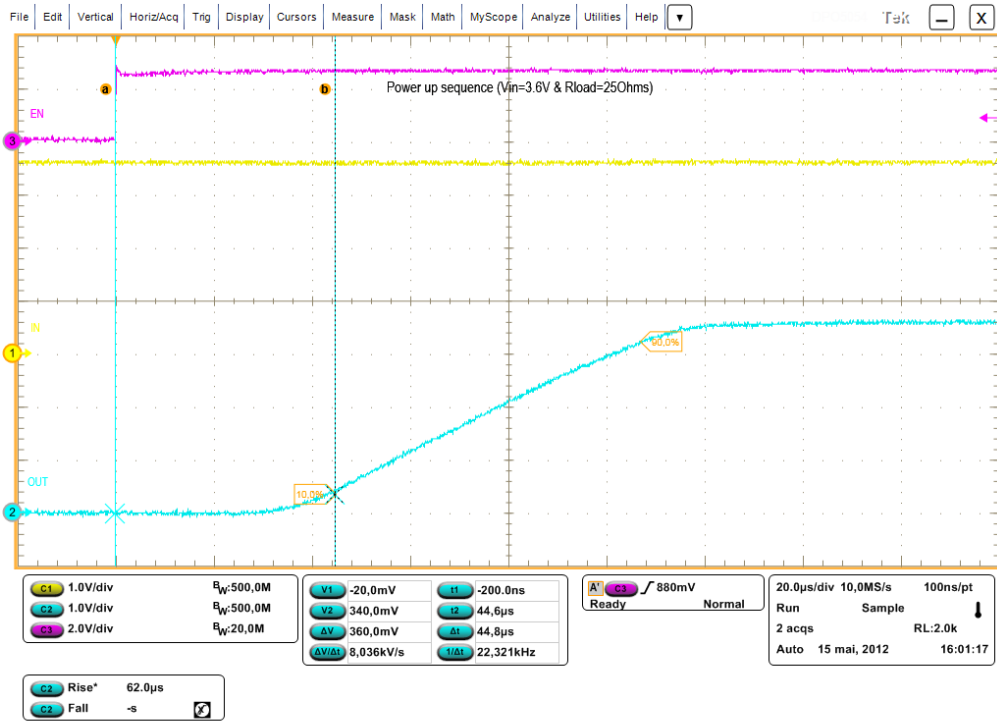

Figure 11. Enable Time, Rise Time, and Ton Time

NCP334, NCP335

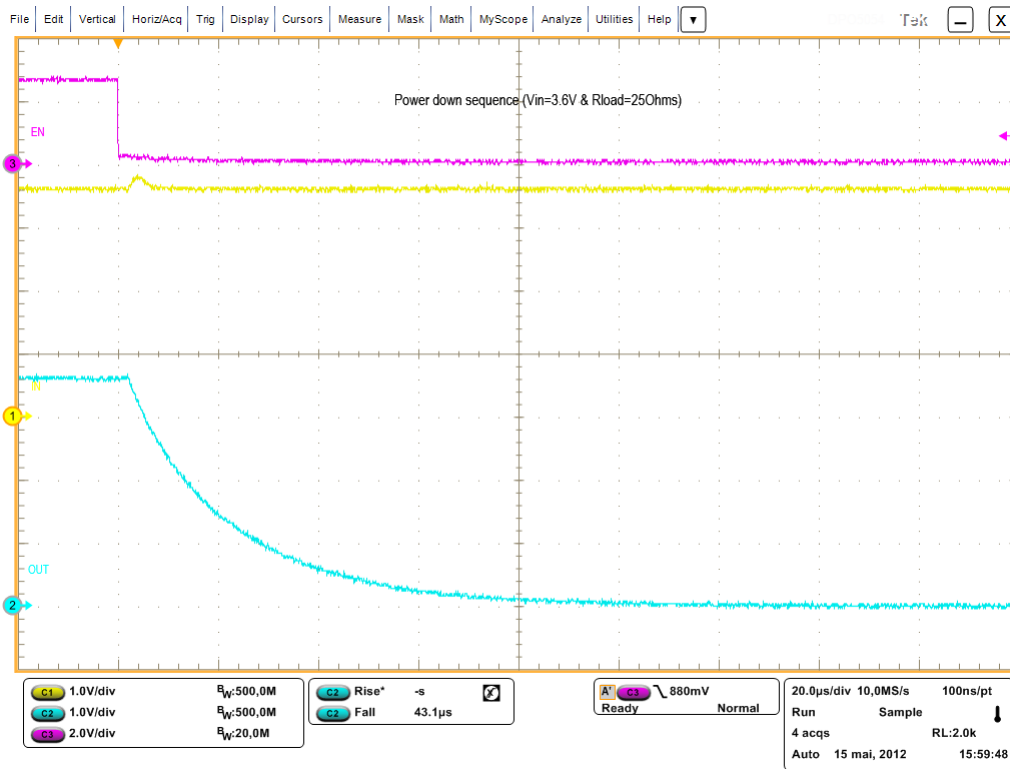

Figure 12. Disable Time, Fall Time and Toff Time

FUNCTIONAL DESCRIPTION

Overview

The NCP334 – NCP335 are high side P channel MOSFET power distribution switch designed to isolate ICs connected on the battery in order to save energy. The part can be turned on, with a range of battery from 1.2 V to 5.5 V.

Enable Input

Enable pin is an active high. The path is opened when EN pin is tied low (disable), forcing P MOS switch off.

The IN/OUT path is activated with a minimum of V_{in} of 1.2V and EN forced to high level.

Auto Discharge (NCP335 Only)

NMOS FET is placed between the output pin and GND, in order to discharge the application capacitor connected on OUT pin.

The auto-discharge is activated when EN pin is set to low level (disable state).

The discharge path (Pull down NMOS) stays activated as long as EN pin is set at low level and $V_{IN} > 1.2$ V.

In order to limit the current across the internal discharge N-MOSFET, the typical value is set at 65 Ω .

Cin and Cout Capacitors

IN and OUT, 1 μ F, at least, capacitors must be placed as close as possible the part for stability improvement.

NCP334, NCP335

APPLICATION INFORMATION

Power Dissipation

Main contributor in term of junction temperature is the power dissipation of the power MOSFET. Assuming this, the power dissipation and the junction temperature in normal mode can be calculated with the following equations:

$$P_D = R_{DS(on)} \times (I_{OUT})^2$$

P_D = Power dissipation (W)

$R_{DS(on)}$ = Power MOSFET on resistance (Ω)

I_{OUT} = Output current (A)

$$T_J = P_D \times R_{\theta JA} + T_A$$

T_J = Junction temperature ($^{\circ}\text{C}$)
 $R_{\theta JA}$ = Package thermal resistance ($^{\circ}\text{C}/\text{W}$)
 T_A = Ambient temperature ($^{\circ}\text{C}$)

PCB Recommendations

The NCP334 – NCP335 integrate an up to 2 A rated PMOS FET, and the PCB design rules must be respected to properly evacuate the heat out of the silicon. By increasing PCB area, especially around IN and OUT pins, the $R_{\theta JA}$ of the package can be decreased, allowing higher power dissipation.

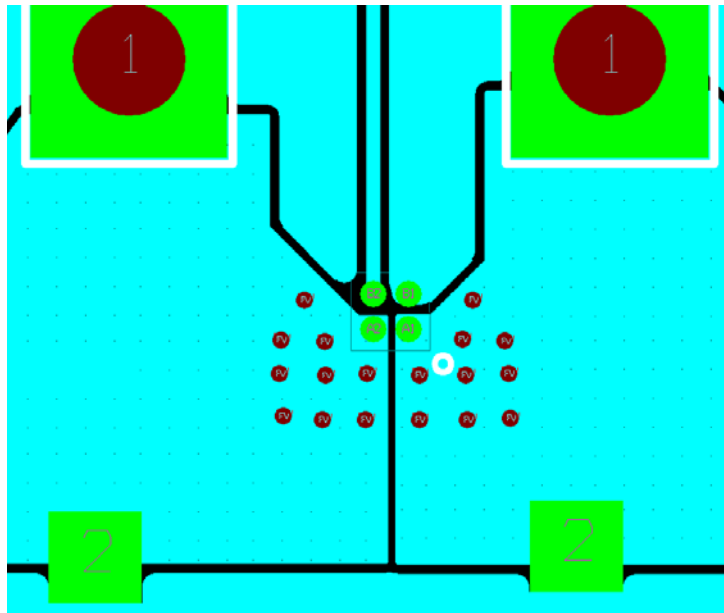

Figure 13. Routing Example 1 oz, 2 Layers, 100°C/W

NCP334, NCP335

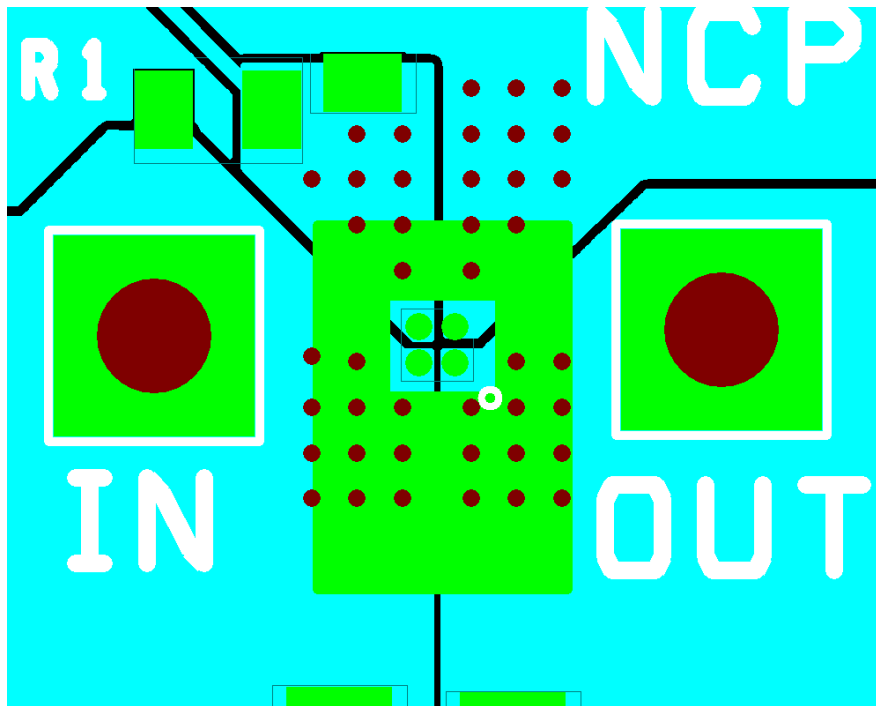

Figure 14. Routing Example 2 oz, 4 Layers, 60°C/W

Example of application definition.

$$T_J - T_A = R_{\theta JA} \times Pd = R_{\theta JA} \times R_{DS(on)} \times I^2$$

T_J : Junction Temperature.

T_A : Ambient Temperature.

R_{θ} = Thermal resistance between IC and air, through PCB.

$R_{DS(on)}$: Intrinsic resistance of the IC MOSFET.

I: load DC current.

Taking into account of R_{θ} obtain with:

1 oz, 2 layers: 100°C/W.

At 2 A, 25°C ambient temperature, $R_{DS(on)}$ 42 mΩ @ V_{IN} 4.2 V, the junction temperature will be:

$$T_J = T_A + R_{\theta} \times Pd = 25 + (0.042 \times 2^2) \times 100 = 41.8^\circ\text{C/W}$$

Taking into account of R_{θ} obtain with:

2 oz, 4 layers: 60°C/W.

At 2 A, 25°C ambient temperature, $R_{DS(on)}$ 42 mΩ @ V_{IN} 4.2 V, the junction temperature will be:

$$T_J = T_A + R_{\theta} \times Pd = 25 + (0.042 \times 2^2) \times 60 = 35^\circ\text{C}.$$

ORDERING INFORMATION

Device	Marking	Package	Shipping†
NCP334FCT2G	AD	WLCSP 0.96 x 0.96 mm (Pb-Free)	3000 / Tape & Reel
NCP335FCT2G	AA	WLCSP 0.96 x 0.96 mm (Pb-Free)	3000 / Tape & Reel

†For information on tape and reel specifications, including part orientation and tape sizes, please refer to our Tape and Reel Packaging Specifications Brochure, BRD8011/D.

NCP334, NCP335

PACKAGE DIMENSIONS

WLCSP4, 0.96x0.96
CASE 567FG
ISSUE O

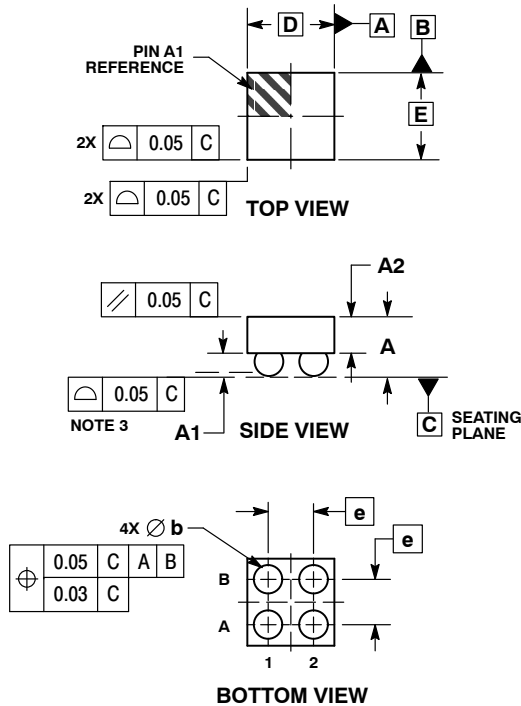

NOTES:

1. DIMENSIONING AND TOLERANCING PER ASME Y14.5M, 1994.
2. CONTROLLING DIMENSION: MILLIMETERS.
3. COPLANARITY APPLIES TO SPHERICAL CROWNS OF SOLDER BALLS.

MILLIMETERS		
DIM	MIN	MAX
A	0.54	0.63
A1	0.22	0.28
A2	0.33 REF	
b	0.29	0.34
D	0.96 BSC	
E	0.96 BSC	
e	0.50 BSC	

RECOMMENDED SOLDERING FOOTPRINT*

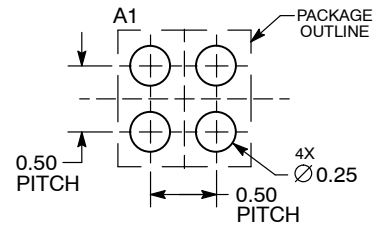

DIMENSIONS: MILLIMETERS

*For additional information on our Pb-Free strategy and soldering details, please download the ON Semiconductor Soldering and Mounting Techniques Reference Manual, SOLDERRM/D.

ON Semiconductor and are registered trademarks of Semiconductor Components Industries, LLC (SCILLC). SCILLC owns the rights to a number of patents, trademarks, copyrights, trade secrets, and other intellectual property. A listing of SCILLC's product/patent coverage may be accessed at www.onsemi.com/site/pdf/Patent-Marking.pdf. SCILLC reserves the right to make changes without further notice to any products herein. SCILLC makes no warranty, representation or guarantee regarding the suitability of its products for any particular purpose, nor does SCILLC assume any liability arising out of the application or use of any product or circuit, and specifically disclaims any and all liability, including without limitation special, consequential or incidental damages. "Typical" parameters which may be provided in SCILLC data sheets and/or specifications can and do vary in different applications and actual performance may vary over time. All operating parameters, including "Typicals" must be validated for each customer application by customer's technical experts. SCILLC does not convey any license under its patent rights nor the rights of others. SCILLC products are not designed, intended, or authorized for use as components in systems intended for surgical implant into the body, or other applications intended to support or sustain life, or for any other application in which the failure of the SCILLC product could create a situation where personal injury or death may occur. Should Buyer purchase or use SCILLC products for any such unintended or unauthorized application, Buyer shall indemnify and hold SCILLC and its officers, employees, subsidiaries, affiliates, and distributors harmless against all claims, costs, damages, and expenses, and reasonable attorney fees arising out of, directly or indirectly, any claim of personal injury or death associated with such unintended or unauthorized use, even if such claim alleges that SCILLC was negligent regarding the design or manufacture of the part. SCILLC is an Equal Opportunity/Affirmative Action Employer. This literature is subject to all applicable copyright laws and is not for resale in any manner.

PUBLICATION ORDERING INFORMATION

LITERATURE FULFILLMENT:
Literature Distribution Center for ON Semiconductor
P.O. Box 5163, Denver, Colorado 80217 USA
Phone: 303-675-2175 or 800-344-3860 Toll Free USA/Canada
Fax: 303-675-2176 or 800-344-3867 Toll Free USA/Canada
Email: orderlit@onsemi.com

N. American Technical Support: 800-282-9855 Toll Free
USA/Canada
Europe, Middle East and Africa Technical Support:
Phone: 421 33 790 2910
Japan Customer Focus Center
Phone: 81-3-5817-1050

ON Semiconductor Website: www.onsemi.com
Order Literature: <http://www.onsemi.com/orderlit>
For additional information, please contact your local Sales Representative

NCP334/D