

0.8 V to 2.5 V, 28 mΩ, Slew Rate Controlled Load Switch in WCSP4

DESCRIPTION

The SiP32454 and SiP32455 are slew rate controlled integrated high side load switches that operate in the input voltage range from 0.8 V to 2.5 V. The SiP32454 and SiP32455 are of N-channel MOSFET switching elements that provide 28 mΩ switch on resistance. They have a 1 ms at 1.2 V and 1.5 ms at 2.5 V slow slew rate that limits the in-rush current and minimizes the switching noise. These devices' low voltage logic control threshold can interface with low voltage control I/O directly without extra level shift or driver. A 2 MΩ pull-down resistor is integrated at logic control EN pin. SiP32454 integrates a switch OFF output discharge circuit.

Both SiP32454 and SiP32455 are available in compact wafer level CSP package, WCSP4 0.8 mm x 0.8 mm with 0.4 mm pitch.

FEATURES

- Low input voltage, 0.8 V to 2.5 V
- Low R_{ON} , 28 mΩ typical
- Slew rate control
- Low logic control with hysteresis
- Reverse current blocking when disabled
- Integrated output discharge switch for SiP32454
- Integrated pull down resistor at EN pin
- 4 bump WCSP 0.8 mm x 0.8 mm with 0.4 mm pitch package
- Material categorization: For definitions of compliance please see www.vishay.com/doc?9991



RoHS
COMPLIANT
HALOGEN
FREE
Available

APPLICATIONS

- Battery operated devices
- Smart phones
- GPS and PMP
- Computer
- Medical and healthcare equipment
- Industrial and instrument
- Cellular phones and portable media players
- Game console

TYPICAL APPLICATION CIRCUIT

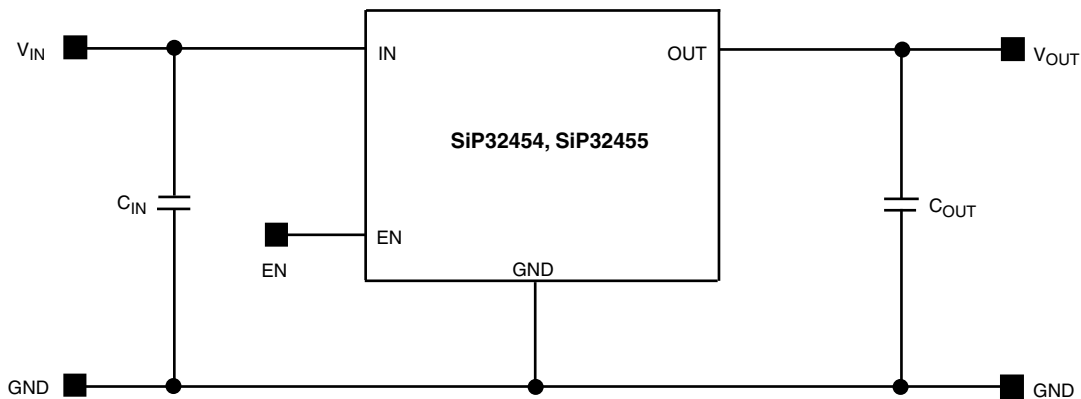

Figure 1 - SiP32454 and SiP32455 Typical Application Circuit

| ORDERING INFORMATION | | | |
|----------------------|--|---------|-------------------|
| Temperature Range | Package | Marking | Part Number |
| - 40 °C to 85 °C | WCSP: 4 Bumps (2 x 2, 0.4 mm pitch, 208 μm bump height, 0.8 mm x 0.8 mm die size) | AD | SiP32454DB-T2-GE1 |
| | | AE | SiP32455DB-T2-GE1 |

Note:

GE1 denotes halogen-free and RoHS compliant

| ABSOLUTE MAXIMUM RATINGS | | |
|--|---------------|------|
| Parameter | Limit | Unit |
| Supply Input Voltage (V_{IN}) | - 0.3 to 2.75 | V |
| Enable Input Voltage (V_{EN}) | - 0.3 to 2.75 | |
| Output Voltage (V_{OUT}) | - 0.3 to 2.75 | |
| Maximum Continuous Switch Current ($I_{max.}$) | 1.2 | A |
| Maximum Pulsed Current (I_{DM}) V_{IN} (Pulsed at 1 ms, 10 % Duty Cycle) | 2 | |
| ESD Rating (HBM) | 4000 | V |
| Junction Temperature (T_J) | - 40 to 150 | °C |
| Thermal Resistance (θ_{JA}) ^a | 280 | °C/W |
| Power Dissipation (P_D) ^a | 196 | mW |

Notes:

a. Device mounted with all leads and power pad soldered or welded to PC board.

b. Derate 3.6 mW/°C above $T_A = 70$ °C.

Stresses beyond those listed under "Absolute Maximum Ratings" may cause permanent damage to the device. These are stress ratings only, and functional operation of the device at these or any other conditions beyond those indicated in the operational sections of the specifications is not implied. Exposure to absolute maximum rating/conditions for extended periods may affect device reliability.

| RECOMMENDED OPERATING RANGE | | |
|--------------------------------------|-------------|------|
| Parameter | Limit | Unit |
| Input Voltage Range (V_{IN}) | 0.8 to 2.5 | V |
| Operating Junction Temperature Range | - 40 to 125 | °C |



| SPECIFICATIONS | | | | | | | | |
|------------------------------------|---------------|--|----------------------|--|-------------------|-------------------|-----------------------|---------------|
| Parameter | Symbol | Test Conditions Unless Specified $V_{IN} = 1\text{ V}$, $T_A = -40\text{ }^\circ\text{C}$ to $85\text{ }^\circ\text{C}$ (Typical values are at $T_A = 25\text{ }^\circ\text{C}$) | | Limits | | | Unit | |
| | | | | Min. ^a | Typ. ^b | Max. ^a | | |
| Operating Voltage ^c | V_{IN} | | | 0.8 | - | 2.5 | V | |
| Quiescent Current | I_Q | $V_{IN} = 1.2\text{ V}$, $V_{EN} = V_{IN}$, OUT = open | | - | 10 | 15 | μA | |
| | | $V_{IN} = 2.5\text{ V}$, $V_{EN} = V_{IN}$, OUT = open | | - | 34 | 60 | | |
| Off Supply Current | $I_{Q(off)}$ | SiP32454 | EN = GND, OUT = open | - | - | 30 | | |
| | | SiP32455 | | - | - | 1 | | |
| Off Switch Current | $I_{DS(off)}$ | EN = GND, OUT = 0 V | | - | - | 30 | | |
| Reverse Blocking Current | I_{RB} | $V_{OUT} = 2.5\text{ V}$, $V_{IN} = 0.9\text{ V}$, $V_{EN} = 0\text{ V}$ | | - | 0.001 | 30 | | |
| On-Resistance | $R_{DS(on)}$ | $V_{IN} = 1\text{ V}$, $I_L = 200\text{ mA}$, $T_A = 25\text{ }^\circ\text{C}$ | | - | 30 | 35 | $\text{m}\Omega$ | |
| | | $V_{IN} = 1.2\text{ V}$, $I_L = 200\text{ mA}$, $T_A = 25\text{ }^\circ\text{C}$ | | - | 29 | 35 | | |
| | | $V_{IN} = 1.8\text{ V}$, $I_L = 200\text{ mA}$, $T_A = 25\text{ }^\circ\text{C}$ | | - | 28 | 35 | | |
| | | $V_{IN} = 2.5\text{ V}$, $I_L = 200\text{ mA}$, $T_A = 25\text{ }^\circ\text{C}$ | | - | 28 | 35 | | |
| On-Resistance Temp.-Coefficient | TC_{RDS} | | | - | 4100 | - | ppm/ $^\circ\text{C}$ | |
| Output Pulldown Resistance | R_{PD} | $V_{EN} = 0\text{ V}$, $T_A = 25\text{ }^\circ\text{C}$ (SiP32454 only) | | - | 417 | 550 | Ω | |
| EN Input Low Voltage ^c | V_{IL} | $V_{IN} = 1\text{ V}$ | | - | - | 0.1 | V | |
| EN Input High Voltage ^c | V_{IH} | $V_{IN} = 2.5\text{ V}$ | | 1.5 | - | - | | |
| EN Input Leakage | I_{EN} | $V_{IN} = 2.5\text{ V}$, $V_{EN} = 0\text{ V}$ | | - | - | 1 | μA | |
| | | $V_{IN} = 2.5\text{ V}$, $V_{EN} = 2.5\text{ V}$ | | - | 6.5 | 12 | | |
| Output Turn-On Delay Time | $t_{d(on)}$ | $V_{IN} = 1.2\text{ V}$ | | - | 0.6 | 1.2 | ms | |
| | | $V_{IN} = 2.5\text{ V}$ | | - | 0.6 | 1.2 | | |
| Output Turn-On Rise Time | t_r | $V_{IN} = 1.2\text{ V}$ | | $R_{LOAD} = 10\text{ }\Omega$, $C_L = 0.1\text{ }\mu\text{F}$, $T_A = 25\text{ }^\circ\text{C}$ | 0.4 | 1 | | 1.6 |
| | | $V_{IN} = 2.5\text{ V}$ | | | 0.5 | 1.5 | | 2.5 |
| Output Turn-Off Delay Time | $t_{d(off)}$ | $V_{IN} = 1.2\text{ V}$ | | | - | 0.3 | 1 | μs |
| | | $V_{IN} = 2.5\text{ V}$ | | | - | 0.1 | 1 | |

Notes:

- a. The algebraic convention whereby the most negative value is a minimum and the most positive a maximum.
- b. Typical values are for DESIGN AID ONLY, not guaranteed nor subject to production testing.
- c. For V_{IN} outside this range consult typical EN threshold curve.

PIN CONFIGURATION

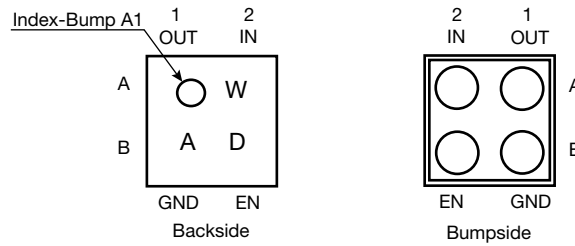
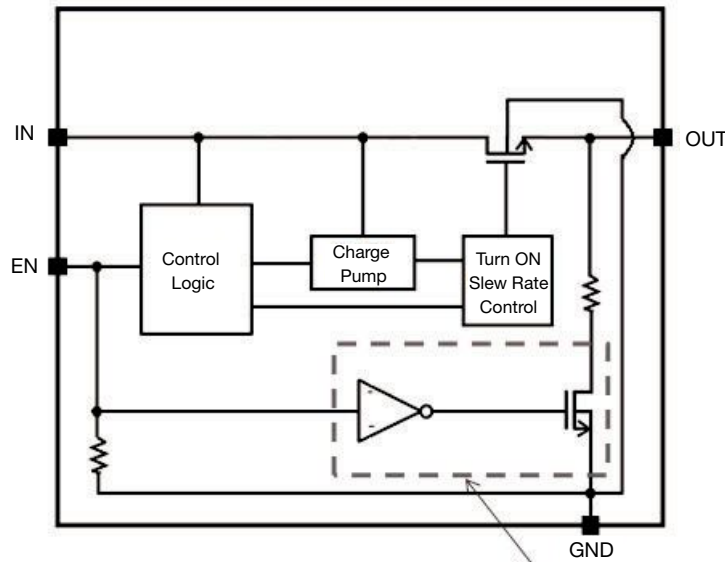

Figure 2 - WCSP 2 x 2 Package

| PIN DESCRIPTION | | |
|-----------------|------|--------------------------------------|
| Pin Number | Name | Function |
| A1 | OUT | This is the output pin of the switch |
| A2 | IN | This is the input pin of the switch |
| B1 | GND | Ground connection |
| B2 | EN | Enable input |

BLOCK DIAGRAM



For SiP32454 only

Figure 3 - Functional Block Diagram

TYPICAL CHARACTERISTICS (25 °C, unless otherwise noted)

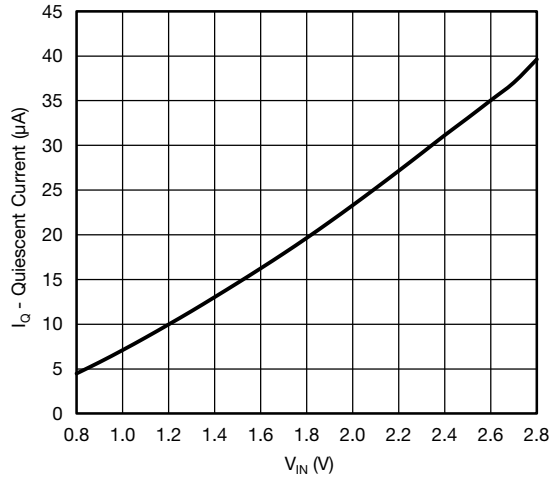

Quiescent vs. Input Voltage

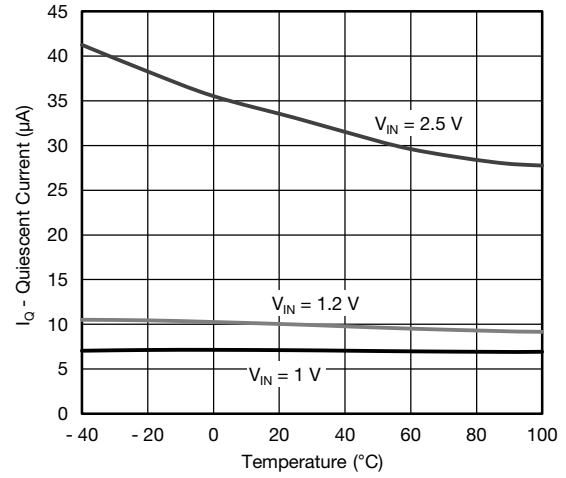

Quiescent vs. Temperature

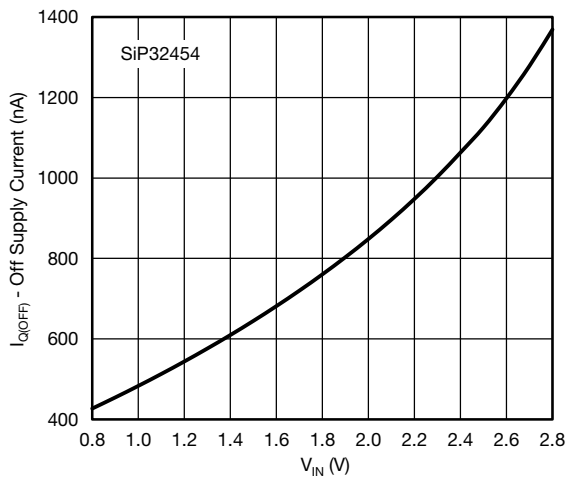

Off Supply Current vs. Input Voltage

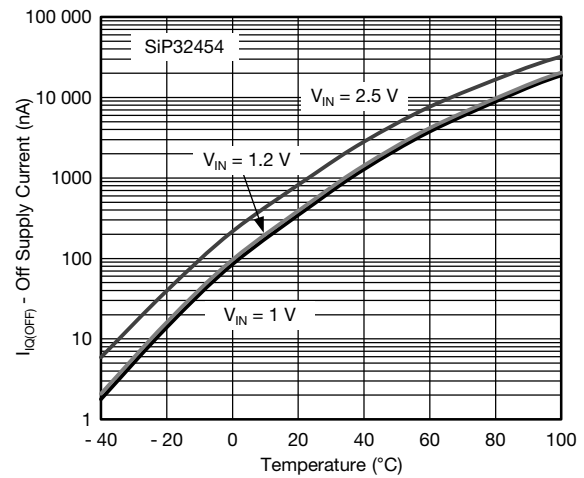

Off Supply Current vs. Temperature

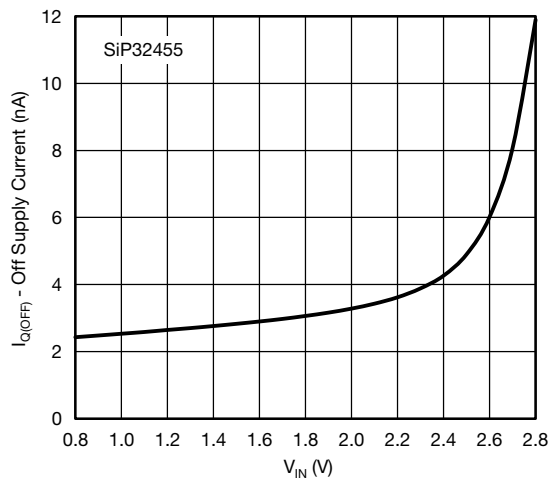

Off Supply Current vs. Input Voltage

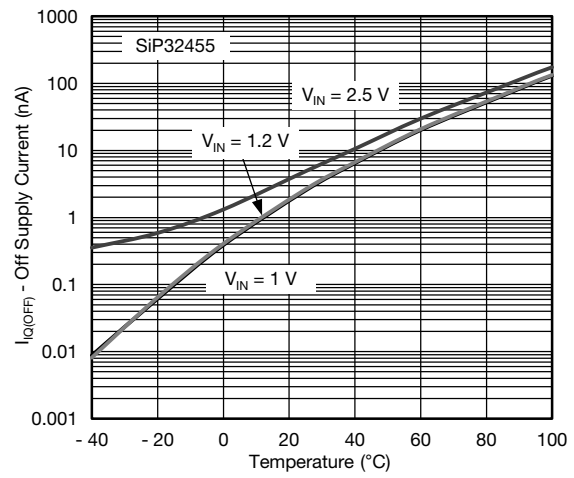

Off Supply Current vs. Temperature

TYPICAL CHARACTERISTICS (25 °C, unless otherwise noted)

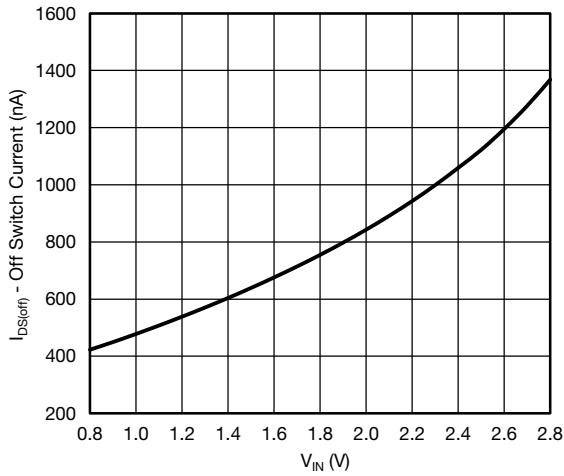

Off Switch Current vs. Input Voltage

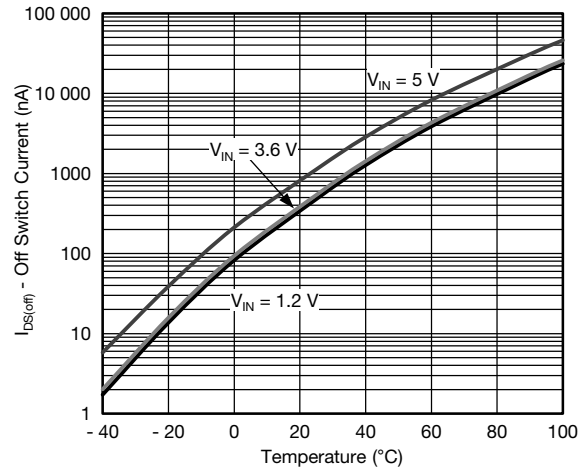

Off Switch Current vs. Temperature

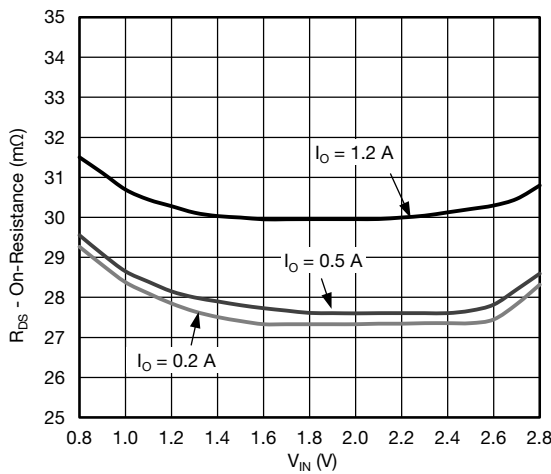

On Resistance vs. Input Voltage

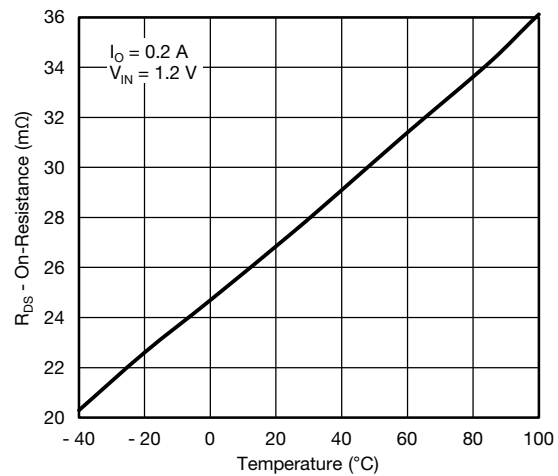

On Resistance vs. Temperature

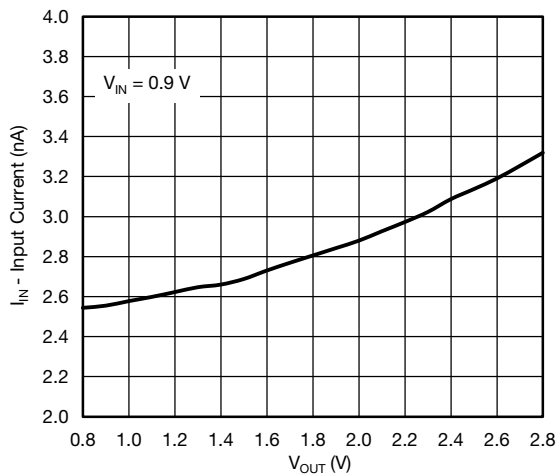

Reverse Blocking Current vs. Output Voltage

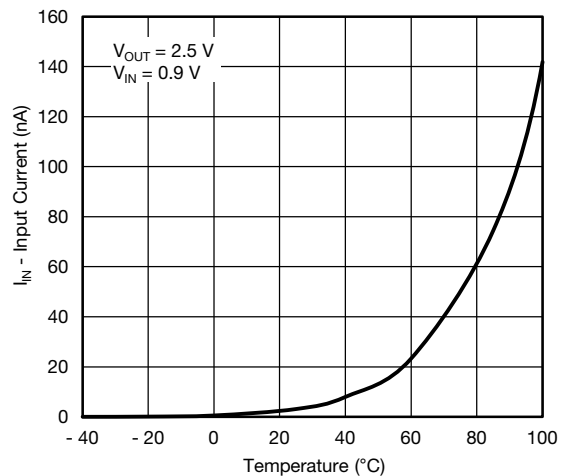

Reverse Blocking Current vs. Temperature

TYPICAL CHARACTERISTICS (25 °C, unless otherwise noted)

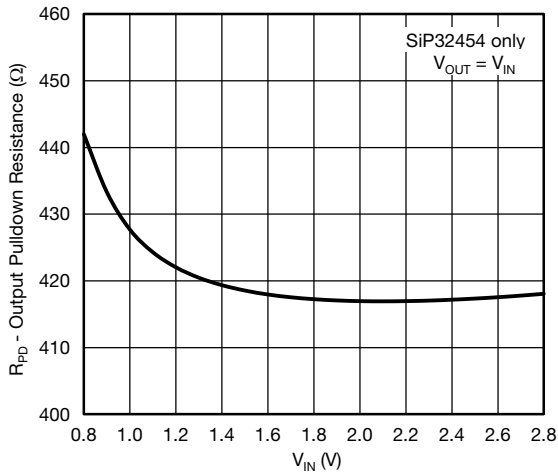

Output Pulldown Resistance vs. Input Voltage

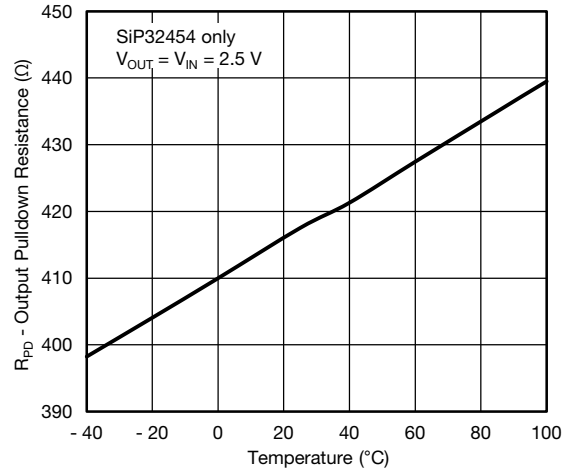

Output Pulldown Resistance vs. Temperature

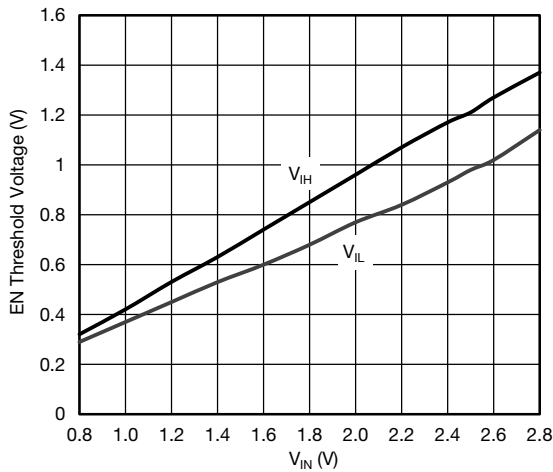

EN Threshold Voltage vs. Input Voltage

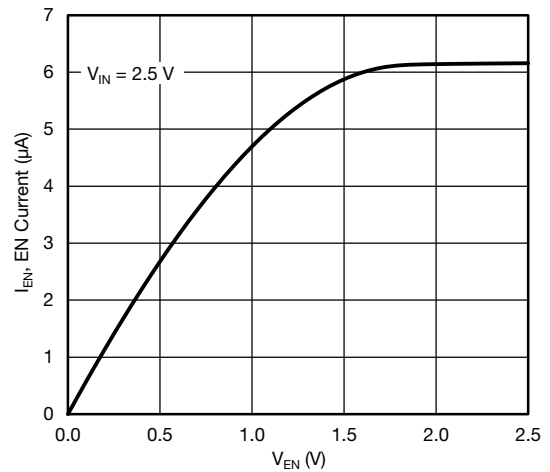

EN Input Leakage vs. V_{EN}

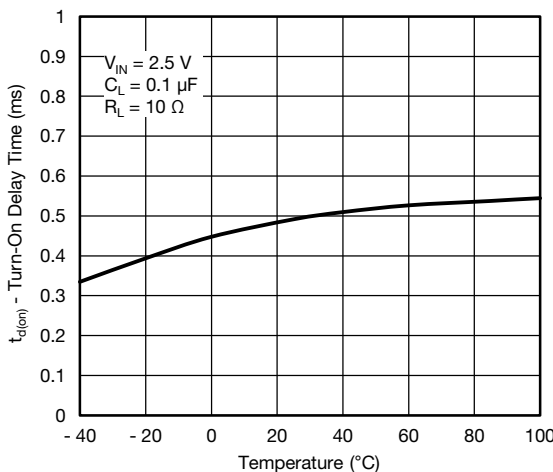

Turn-On Delay Time vs. Temperature

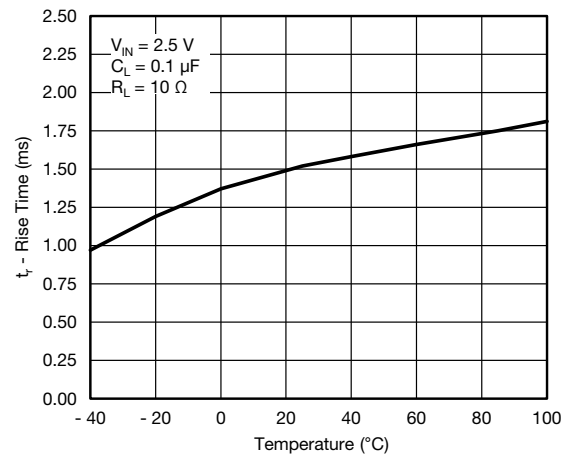

Rise Time vs. Temperature

ELECTRICAL CHARACTERISTICS

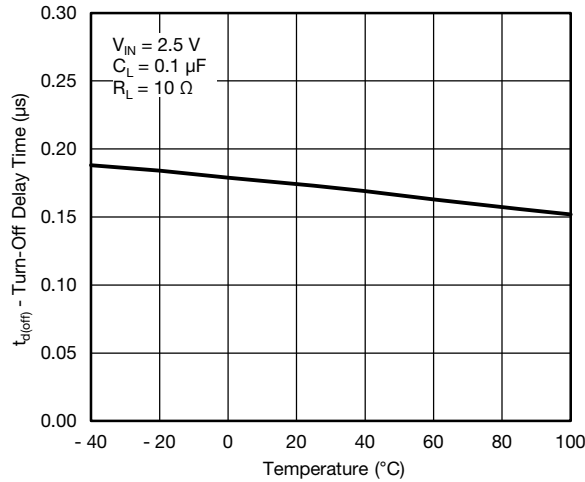

Turn-Off Delay Time vs. Temperature

TYPICAL WAVEFORMS

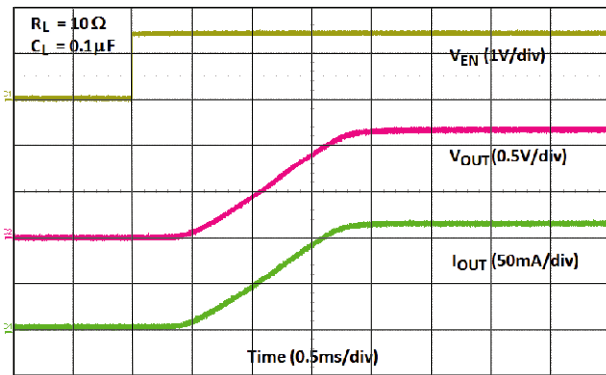

Turn-On Time ($V_{IN} = 1.2 V$)

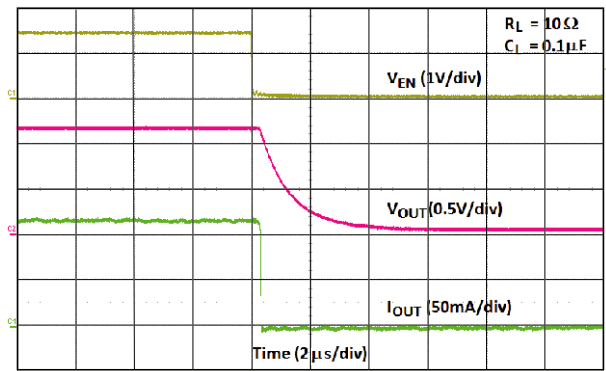

Turn-Off Time ($V_{IN} = 1.2 V$)

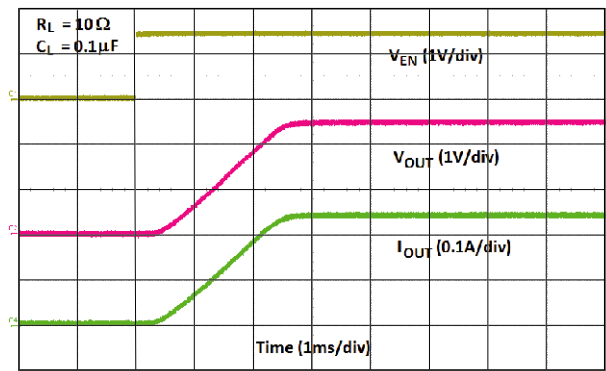

Turn-On Time ($V_{IN} = 2.5 V$)

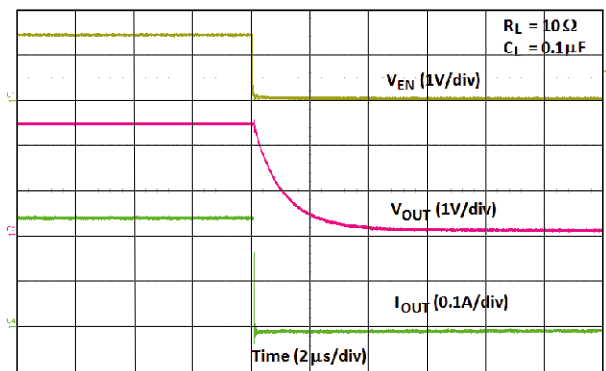

Turn-Off Time ($V_{IN} = 2.5 V$)

DETAILED DESCRIPTION

SiP32454 and SiP32455 are n-channel power MOSFET designed as high side load switch. Once enable the device charge pumps the gate of the power MOSFET to a constant gate to source voltage for fast turn on time. The mostly constant gate to source voltage keeps the on resistance low through out the input voltage range. SiP32454 and SiP32455 are designed with slow slew rate to minimize the inrush current during turn on. Because the body of the output n-channel is always connected to GND, it prevents the current from going back to the input in case the output voltage is higher than the input. The SiP32454 especially incorporates an active output pulldown resistor to discharge output capacitance when the device is off.

APPLICATION INFORMATION

Input Capacitor

While a bypass capacitor on the input is not required, a 4.7 μF or larger capacitor for C_{IN} is recommended in almost all applications. The bypass capacitor should be placed as physically close as possible to the input pin to be effective in minimizing transients on the input. Ceramic capacitors are recommended over tantalum because of their ability to withstand input current surges from low impedance sources such as batteries in portable devices.

Output Capacitor

A 0.1 μF capacitor across V_{OUT} and GND is recommended to insure proper slew operation. There is inrush current through the output MOSFET and the magnitude of the inrush current depends on the output capacitor, the bigger the C_{OUT} the higher the inrush current. There are no ESR or capacitor type requirement.

Enable

The EN pin is compatible with CMOS logic voltage levels. It requires at least 0.1 V or below to fully shut down the device and 1.5 V or above to fully turn on the device.

Protection Against Reverse Voltage Condition

Both the SiP32454 and SiP32455 can block the output current from going to the input in case where the output voltage is higher than the input voltage when the main switch is off.

Thermal Considerations

These devices are designed to maintain a constant output load current. Due to physical limitations of the layout and assembly of the device the maximum switch current is 1.2 A as stated in the Absolute Maximum Ratings table. However, another limiting characteristic for the safe operating load current is the thermal power dissipation of the package. To obtain the highest power dissipation (and a thermal resistance of 280 $^{\circ}\text{C}/\text{W}$) the device should be connected to a heat sink on the printed circuit board.

The maximum power dissipation in any application is dependant on the maximum junction temperature, $T_{J(\text{max.})} = 125\text{ }^{\circ}\text{C}$, the junction-to-ambient thermal resistance, $\theta_{J-A} = 280\text{ }^{\circ}\text{C}/\text{W}$, and the ambient temperature, T_A , which may be formulaically expressed as:

$$P(\text{max.}) = \frac{T_{J(\text{max.})} - T_A}{\theta_{J-A}} = \frac{125 - T_A}{280}$$

It then follows that, assuming an ambient temperature of 70 $^{\circ}\text{C}$, the maximum power dissipation will be limited to about 196 mW.

So long as the load current is below the 1.2 A limit, the maximum continuous switch current becomes a function two things: the package power dissipation and the $R_{DS(\text{ON})}$ at the ambient temperature.

As an example let us calculate the worst case maximum load current at $T_A = 70\text{ }^{\circ}\text{C}$. The worst case $R_{DS(\text{ON})}$ at 25 $^{\circ}\text{C}$ is 35 m Ω . The $R_{DS(\text{ON})}$ at 70 $^{\circ}\text{C}$ can be extrapolated from this data using the following formula:

$$R_{DS(\text{ON})}(\text{at } 70\text{ }^{\circ}\text{C}) = R_{DS(\text{ON})}(\text{at } 25\text{ }^{\circ}\text{C}) \times (1 + T_C \times \Delta T)$$

Where T_C is 4100 ppm/ $^{\circ}\text{C}$. Continuing with the calculation we have

$$R_{DS(\text{ON})}(\text{at } 70\text{ }^{\circ}\text{C}) = 35\text{ m}\Omega \times (1 + 0.0041 \times (70\text{ }^{\circ}\text{C} - 25\text{ }^{\circ}\text{C})) = 42.2\text{ m}\Omega$$

The maximum current limit is then determined by

$$I_{\text{LOAD}}(\text{max.}) < \sqrt{\frac{P(\text{max.})}{R_{DS(\text{ON})}}}$$

which in this case is 2.1 A. Under the stated input voltage condition, if the 2.1 A current limit is exceeded the internal die temperature will rise and eventually, possibly damage the device.

To avoid possible permanent damage to the device and keep a reasonable design margin, it is recommended to operate the device maximum up to 1.2 A only as listed in the Absolute Maximum Ratings table.

PACKAGE OUTLINE

WCSP: 4 Bumps (2 x 2, 0.4 mm Pitch, 208 μm Bump Height, 0.8 mm x 0.8 mm Die Size)

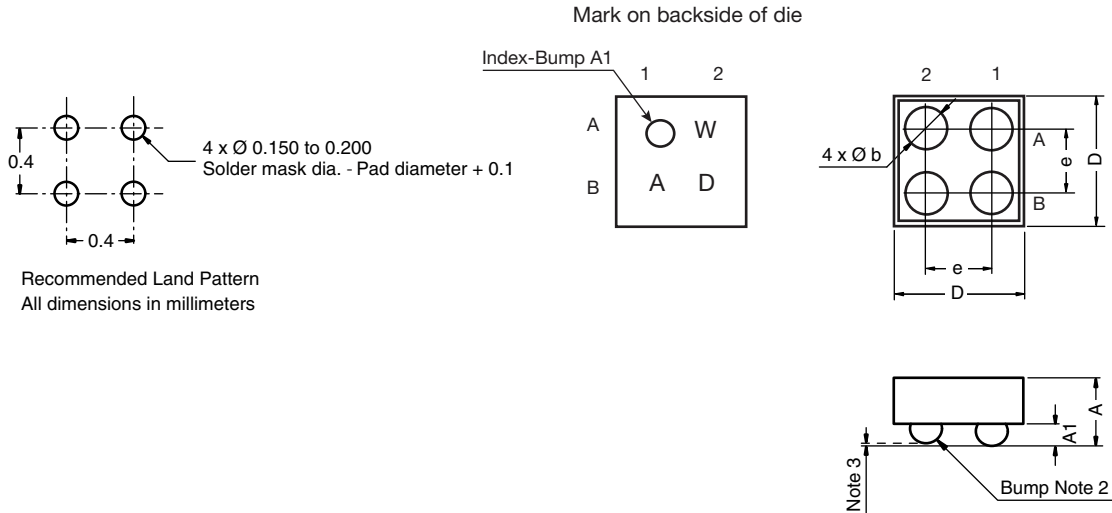

| Dimension | MILLIMETERS | | | INCHES | | |
|-----------|-------------|-------|-------|--------|--------|--------|
| | Min. | Nom. | MAX. | Min. | Nom. | MAX. |
| A | 0.515 | 0.530 | 0.545 | 0.0202 | 0.0208 | 0.0214 |
| A1 | 0.208 | | | 0.0081 | | |
| b | 0.250 | 0.260 | 0.270 | 0.0098 | 0.0102 | 0.0106 |
| e | 0.400 | | | 0.0157 | | |
| D | 0.720 | 0.760 | 0.800 | 0.0182 | 0.0193 | 0.0203 |

Notes:

1. Laser mark on the backside surface of die.
2. Bumps are SAC396.
3. 0.050 max. coplanarity.

Vishay Siliconix maintains worldwide manufacturing capability. Products may be manufactured at one of several qualified locations. Reliability data for Silicon Technology and Package Reliability represent a composite of all qualified locations. For related documents such as package/tape drawings, part marking, and reliability data, see www.vishay.com/ppg?62531



Disclaimer

ALL PRODUCT, PRODUCT SPECIFICATIONS AND DATA ARE SUBJECT TO CHANGE WITHOUT NOTICE TO IMPROVE RELIABILITY, FUNCTION OR DESIGN OR OTHERWISE.

Vishay Intertechnology, Inc., its affiliates, agents, and employees, and all persons acting on its or their behalf (collectively, "Vishay"), disclaim any and all liability for any errors, inaccuracies or incompleteness contained in any datasheet or in any other disclosure relating to any product.

Vishay makes no warranty, representation or guarantee regarding the suitability of the products for any particular purpose or the continuing production of any product. To the maximum extent permitted by applicable law, Vishay disclaims (i) any and all liability arising out of the application or use of any product, (ii) any and all liability, including without limitation special, consequential or incidental damages, and (iii) any and all implied warranties, including warranties of fitness for particular purpose, non-infringement and merchantability.

Statements regarding the suitability of products for certain types of applications are based on Vishay's knowledge of typical requirements that are often placed on Vishay products in generic applications. Such statements are not binding statements about the suitability of products for a particular application. It is the customer's responsibility to validate that a particular product with the properties described in the product specification is suitable for use in a particular application. Parameters provided in datasheets and/or specifications may vary in different applications and performance may vary over time. All operating parameters, including typical parameters, must be validated for each customer application by the customer's technical experts. Product specifications do not expand or otherwise modify Vishay's terms and conditions of purchase, including but not limited to the warranty expressed therein.

Except as expressly indicated in writing, Vishay products are not designed for use in medical, life-saving, or life-sustaining applications or for any other application in which the failure of the Vishay product could result in personal injury or death. Customers using or selling Vishay products not expressly indicated for use in such applications do so at their own risk. Please contact authorized Vishay personnel to obtain written terms and conditions regarding products designed for such applications.

No license, express or implied, by estoppel or otherwise, to any intellectual property rights is granted by this document or by any conduct of Vishay. Product names and markings noted herein may be trademarks of their respective owners.

Material Category Policy

Vishay Intertechnology, Inc. hereby certifies that all its products that are identified as RoHS-Compliant fulfill the definitions and restrictions defined under Directive 2011/65/EU of The European Parliament and of the Council of June 8, 2011 on the restriction of the use of certain hazardous substances in electrical and electronic equipment (EEE) - recast, unless otherwise specified as non-compliant.

Please note that some Vishay documentation may still make reference to RoHS Directive 2002/95/EC. We confirm that all the products identified as being compliant to Directive 2002/95/EC conform to Directive 2011/65/EU.

Vishay Intertechnology, Inc. hereby certifies that all its products that are identified as Halogen-Free follow Halogen-Free requirements as per JEDEC JS709A standards. Please note that some Vishay documentation may still make reference to the IEC 61249-2-21 definition. We confirm that all the products identified as being compliant to IEC 61249-2-21 conform to JEDEC JS709A standards.