

IS31LT3350

40V LED DRIVER WITH INTERNAL SWITCH

OCTOBER 2011

GENERAL DESCRIPTION

The IS31LT3350 is a continuous mode inductive step-down converter, designed for driving a single LED or multiple series connected LEDs efficiently from a voltage source higher than the LED voltage. The chip operates from an input supply between 6V and 40V and provides an externally adjustable output current of up to 750mA. Depending upon supply voltage and external components, this can provide up to 30 watts of output power.

The IS31LT3350 includes an integrated output switch and a high-side output current sensing circuit, which uses an external resistor to set the nominal average output current.

Output current can be adjusted linearly by applying an external control signal to the ADJ pin. The ADJ pin will accept either a DC voltage or a PWM waveform. This will provide either a continuous or a gated output current. Applying a voltage of 0.2V or lower to the ADJ pin turns the output off and switches the chip into a low current standby state.

The chip is assembled in SOT23-5 and SOT89-5 package. SOT23-5 is available for 350mA output current application. SOT89-5 is available for 750mA output current application.

FEATURES

- Simple low parts count
- Internal 40V power switch
- Wide input voltage range: 6V to 40V
- Up to 750mA output current (SOT89-5 package)
- High efficiency (up to 95%)
- Typical 1200 : 1 dimming ratio
- Typical 5% output current accuracy
- Single pin on/off and brightness control using DC voltage or PWM
- Up to 1MHz switching frequency
- Inherent open-circuit LED protection
- Thermal shutdown protection circuitry
- Two packages available for different current

APPLICATIONS

- Low voltage halogen replacement LEDs
- Automotive lighting
- Low voltage industrial lighting
- LED back-up lighting
- Illuminated sign

APPLICATION CIRCUIT

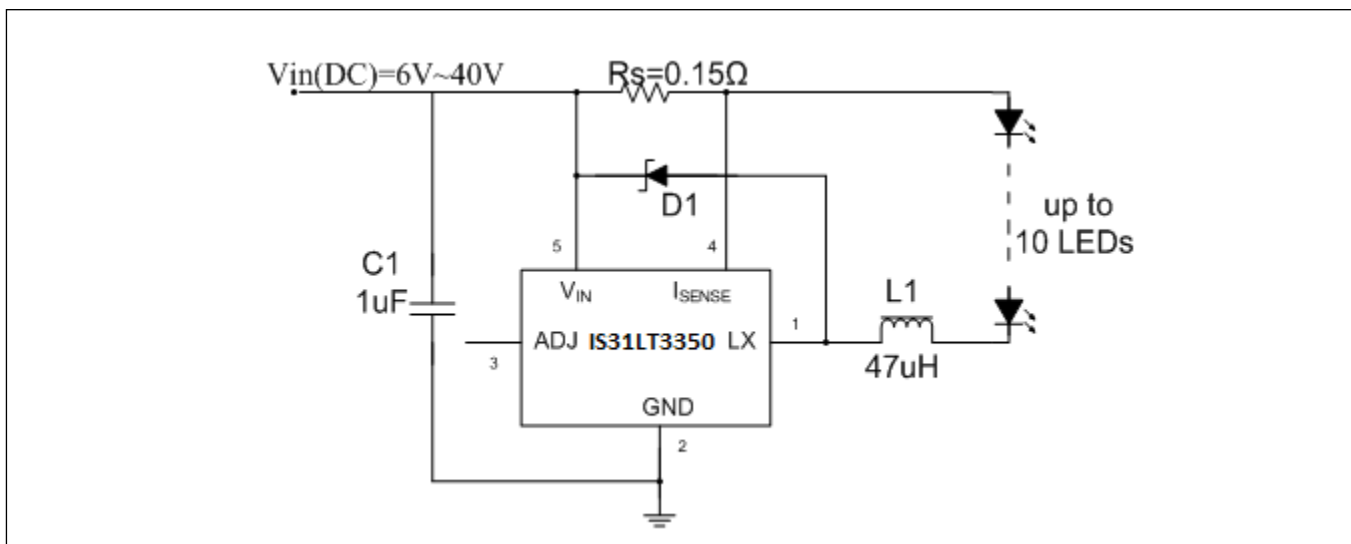

Copyright © 2011 Integrated Silicon Solution, Inc. All rights reserved. ISSI reserves the right to make changes to this specification and its products at any time without notice. ISSI assumes no liability arising out of the application or use of any information, products or services described herein. Customers are advised to obtain the latest version of this device specification before relying on any published information and before placing orders for products. Integrated Silicon Solution, Inc. does not recommend the use of any of its products in life support applications where the failure or malfunction of the product can reasonably be expected to cause failure of the life support system or to significantly affect its safety or effectiveness. Products are not authorized for use in such applications unless Integrated Silicon Solution, Inc. receives written assurance to its satisfaction, that:

- a.) the risk of injury or damage has been minimized;
- b.) the user assume all such risks; and
- c.) potential liability of Integrated Silicon Solution, Inc is adequately protected under the circumstances

PIN CONFIGURATIONS

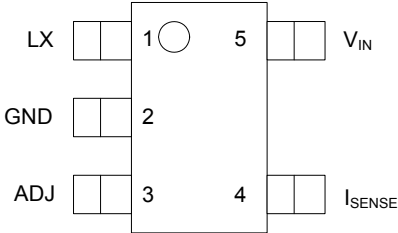
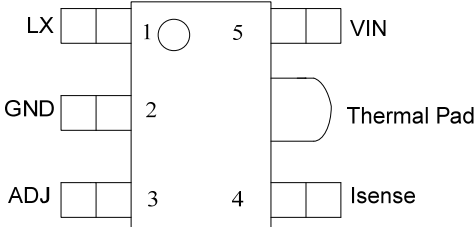
Package	Pin Configurations (Top View)
SOT23-5	
SOT89-5	

PIN DESCRIPTION

Pin Name	NO.	Description
LX	1	Drain of power switch
GND	2	Ground (0V)
ADJ	3	Multi-function On/Off and brightness control pin: * Leave floating for normal operation. ($V_{ADJ} = V_{REF} = 1.2V$ giving nominal average output current $I_{OUT\ nom} = 0.1/R_S$) * Drive to voltage below 0.2V to turn off output current * Drive with DC voltage ($0.3V < V_{ADJ} < 1.2V$) to adjust output current from 25% to 100% of $I_{OUT\ nom}$ * Drive with PWM signal to adjust output current. * When driving the ADJ pin above 1.2V, the current will be clamped to 100% brightness automatically.
I_{SENSE}	4	Connect resistor R_S from this pin to V_{IN} to define nominal average output current $I_{OUT\ nom} = 0.1/R_S$
V_{IN}	5	Input voltage (6V to 40V). Decouple to ground with 1 μ F or higher X7R ceramic capacitor close to device

IS31LT3350

ORDERING INFORMATION

Industrial Range: -40°C to +85°C

Order Part No.	Package	QTY/Reel	V _{SENSE}
IS31LT3350-V1STLS2-TR	SOT23-5, Lead-free	3000	91mV~101mV
IS31LT3350-V2STLS2-TR	SOT23-5, Lead-free	3000	99mV~110mV
IS31LT3350-V1SDLS2-TR	SOT89-5, Lead-free	2500	91mV~101mV
IS31LT3350-V2SDLS2-TR	SOT89-5, Lead-free	2500	99mV~110mV

IS31LT3350

ABSOLUTE MAXIMUM RATINGS (NOTE 1)

Symbol	Parameter	Rating
V_{IN}	Input voltage	-0.3V to +50V
V_{ISENSE}	I_{SENSE} voltage	$V_{IN}+0.3V$ to $V_{IN}-5V$, $V_{IN}>5V$
		$V_{IN}+0.3V$ to $-0.3V$, $V_{IN}<5V$
V_{LX}	LX output voltage	-0.3V to +50V
V_{ADJ}	Adjust pin input voltage	-0.3V to +6V
I_{LX}	Switch output current	800mA@SOT89-5;400mA@ SOT23-5
P_{tot}	Power dissipation	1.2w @SOT89-5;600mw@SOT23-5
T_{OP}	Operating temperature	-40 to 85°C
T_{ST}	Storage temperature	-55 to 150°C
T_{iMAX}	Junction temperature	150°C
$R_{\theta JA}$	Junction to ambient	108°C/W @SOT23-5; 45°C/W @SOT89-5
	ESD Susceptibility(human body mode)	2kV

ELECTRICAL CHARACTERISTICS

($V_{IN}=12V$, $T_A=25^\circ C$ unless otherwise stated) (NOTE 2)

Symbol	Parameter	Conditions	Min.	Typ.	Max.	Unit
V_{IN}	Input voltage		6		40	V
I_{INQoff}	Quiescent supply current with output off	ADJ pin grounded	40	60	80	μA
I_{INQon}	Quiescent supply current with output switching	ADJ pin floating		450	600	μA
V_{SENSE}	Mean current sense threshold voltage	IS31LT3350-V1	91	95	101	mV
		IS31LT3350-V2	99	105	110	
$V_{SENSEHYS}$	Sense threshold hysteresis			± 15		%
I_{SENSE}	I_{SENSE} pin input current	$V_{SENSE} = 0.1V$		8	10	μA
V_{REF}	Internal reference voltage	Measured on ADJ pin with pin floating		1.2		V
V_{ADJ}	External control voltage range on ADJ pin for dc brightness control		0.3		1.2	V
V_{ADJoff}	DC voltage on ADJ pin to switch chip from active (on) state to quiescent (off) state	V_{ADJ} falling	0.15	0.2	0.25	V
V_{ADJon}	DC voltage on ADJ pin to switch chip from quiescent (off) state to active (on) state	V_{ADJ} rising	0.2	0.25	0.3	V
R_{ADJ}	Resistance between ADJ pin and V_{REF}			500		K Ω
I_{LXmean}	Continuous LX switch current	SOT23-5 package		0.35		A
		SOT89-5 package		0.65		

IS31LT3350

ELECTRICAL CHARACTERISTICS (CONTINUED)

($V_{IN}=12V$, $T_A=25^{\circ}C$ unless otherwise stated) (NOTE 2)

Symbol	Parameter	Conditions	Min.	Typ.	Max.	Unit
$I_{LX(leak)}$	LX switch leakage current				1	μA
R_{LX}	LX Switch 'On' resistance			0.9	1.5	Ω
$D_{PWM(LF)}$	Brightness control range at low frequency PWM signal	PWM frequency =100Hz PWM amplitude=5V, $V_{in}=15V$, $L=27\mu H$, Driving 1 LED		1200:1		
$D_{PWM(HF)}$	Brightness control range at low frequency PWM signal	PWM frequency =10KHz PWM amplitude=5V, $V_{in}=15V$, $L=27\mu H$, Driving 1 LED		13:1		
f_{LX}	Operating frequency	ADJ pin floating $L=100\mu H$ (0.82 Ω) $I_{OUT}=350mA$ @ $V_{LED}=3.4V$ Driving 1 LED		154		KHz
T_{ONmin}	Minimum switch 'ON' time	LX switch 'ON'		200		ns
T_{OFFmin}	Minimum switch 'OFF' time	LX switch 'OFF'		200		ns
f_{LXmax}	Recommended maximum operating frequency				1	MHz
D_{LX}	Recommended duty cycle range of output switch at f_{LXmax}		0.3	0.7	0.9	
T_{PD}	Internal comparator propagation delay			50		ns
T_{SD}	Thermal shutdown temperature			140		$^{\circ}C$
T_{SD-HYS}	Thermal shutdown hysteresis			20		$^{\circ}C$

NOTES:

- Stresses beyond those listed under absolute maximum ratings may cause permanent damage to the device. These are stress ratings only, and functional operation of the device at these or any other conditions beyond those indicated under recommended operating conditions is not implied. Exposure to absolute-maximum-rated conditions for extended periods may affect device reliability.
- All parts are production tested at $T_A=25^{\circ}C$. Other temperature limits are guaranteed by design.

IS31LT3350

TYPICAL PERFORMANCE CHARACTERISTICS

For typical application circuit and $T_{amb}=25^{\circ}\text{C}$ unless otherwise stated.

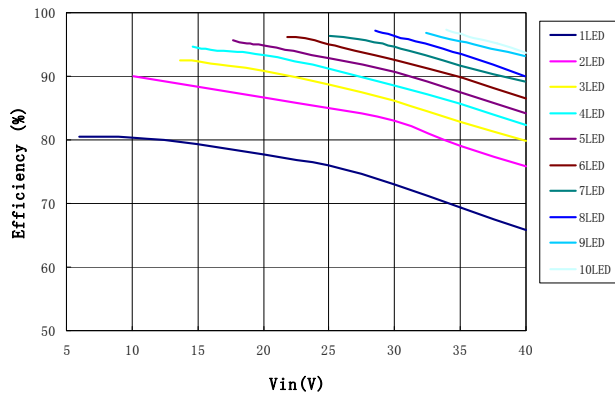

Efficiency vs. No. of LEDs
L=100uH, Rs=0.33Ohm

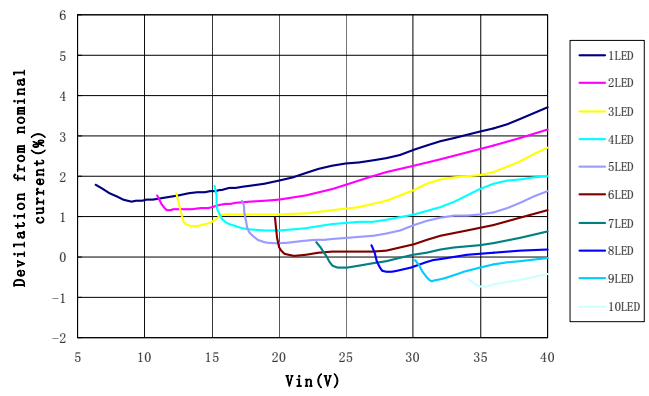

Output current variation with
Supply Voltage L=100uH, Rs=0.33Ohm

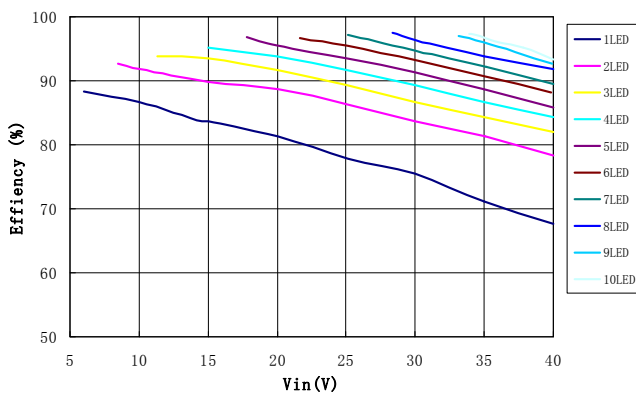

Efficiency vs. No. of LEDs
L=47uH, Rs=0.33Ohm

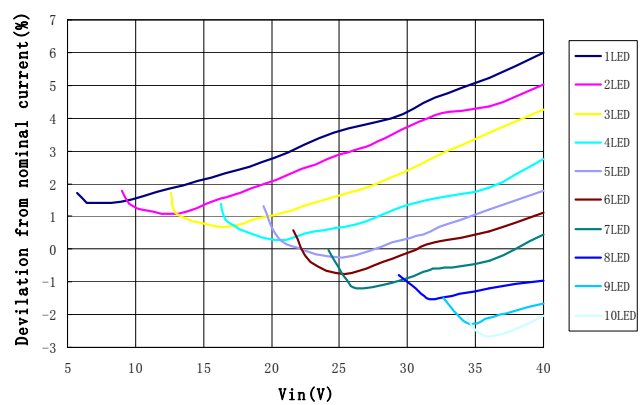

Output current variation with Supply Voltage
L=47uH, Rs=0.33Ohm

TYPICAL PERFORMANCE CHARACTERISTICS (CONTINUED)

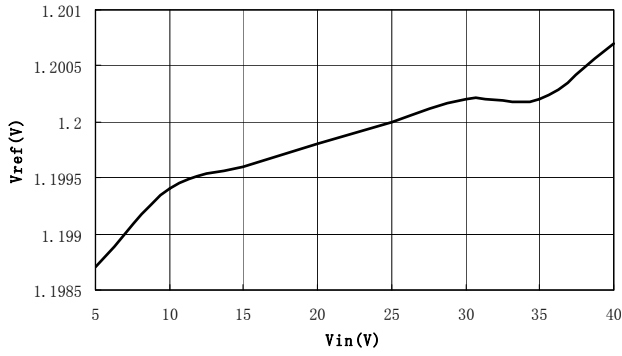

Vref vs. Vin over nominal supply voltage range

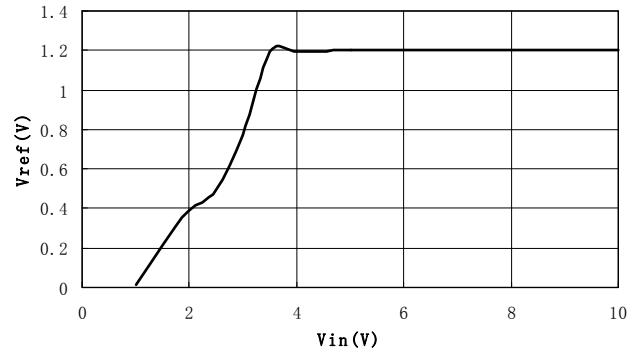

Vref vs. Vin at low supply voltage

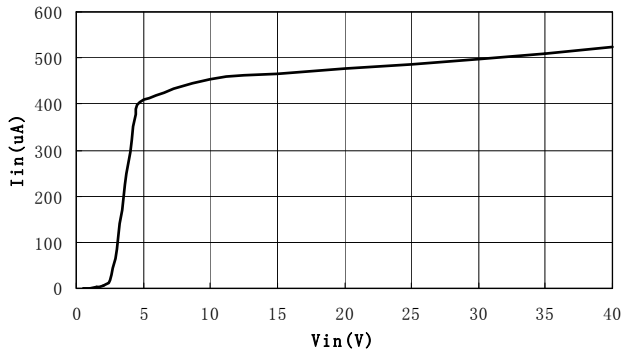

Supply Current vs. Vin (Operating)

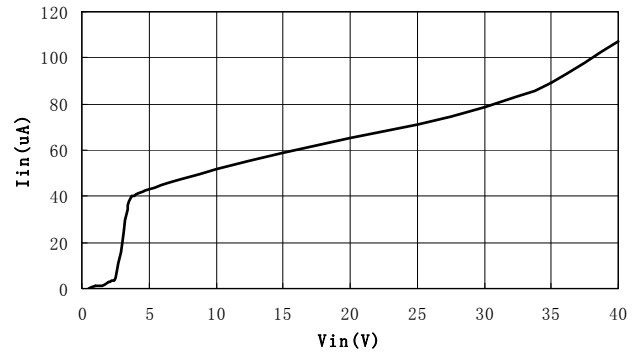

Shutdown Current vs. Vin (Quiescent)

IS31LT3350

APPLICATION INFORMATION

Setting nominal average output current with external resistor R_S

The nominal average output current in the LED(s) is determined by the value of the external current sense resistor (R_S) connected between V_{IN} and I_{SENSE} and is given by:

$$I_{OUT\ nom} = 0.1/R_S \text{ [for } R_S > 0.13\Omega \text{]}$$

The table below gives values of nominal average output current for several preferred values of current setting resistor (R_S) in the typical application circuit shown on page 1:

R_S (Ω)	Nominal average output current (mA)
0.13	769
0.15	667
0.27	370
0.3	333

V_{sense} is divided into two ranges to improve current accuracy, please refer to bin information on page 3. The above values assume that the ADJ pin is floating and at a nominal voltage of $V_{REF} = 1.2V$.

Note that $R_S = 0.13\Omega$ is the minimum allowed value of sense resistor under these conditions to maintain switch current below the specified maximum value. It is possible to use different values of R_S if the ADJ pin is driven from an external voltage.

Output current adjustment by external DC control voltage

The ADJ pin can be driven by an external dc voltage (V_{ADJ}), as shown, to adjust the output current to a value above or below the nominal average value defined by R_S .

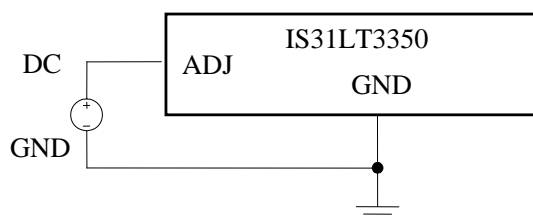

The nominal average output current in this case is given by:

$$I_{OUTdc} = 0.083 * V_{ADJ} / R_S \text{ [for } 0.3V < V_{ADJ} < 1.2V \text{]}$$

Note that 100% brightness setting corresponds to $V_{ADJ} = V_{REF}$. When driving the ADJ pin above 1.2V, the current will be clamped to 100% brightness automatically. The input impedance of the ADJ pin is $500k\Omega \pm 25\%$.

Output current adjustment by PWM control Directly driving ADJ input

A Pulse Width Modulated (PWM) signal with duty cycle D_{PWM} can be applied to the ADJ pin, as shown below, to adjust the output current to a value below the nominal average value set by resistor R_S , the signal range is from 0V~5V. The PWM signal must have the driving ability to drive the internal 500K Ω pull-up resistor.

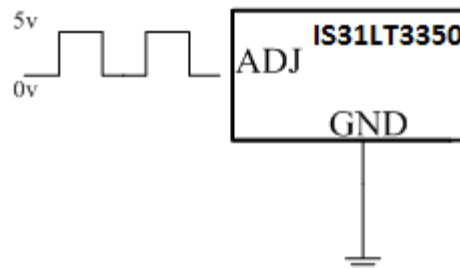

Driving the ADJ input from a microcontroller

Another possibility is to drive the chip from the open drain output of a microcontroller. The diagram below shows one method of doing this:

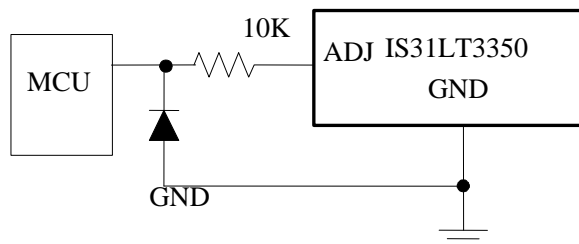

The diode and resistor suppress possible high amplitude negative spikes on the ADJ input resulting from the drain-source capacitance of the FET. Negative spikes at the input to the chip should be avoided as they may cause errors in output current or erratic device operation. See the section on PWM dimming for more details of the various modes of control using high frequency and low frequency PWM signals.

Shutdown mode

Taking the ADJ pin to a voltage below 0.2V will turn off the output and supply current will fall to a low standby level of 60 μA nominal.

Inherent open-circuit LED protection

If the connection to the LED(s) is open-circuited, the coil is isolated from the LX pin of the chip, so the chip will not be damaged, unlike in many boost converters, where the back EMF may damage the internal switch by forcing the drain above its breakdown voltage.

Capacitor selection

A low ESR capacitor should be used for input decoupling, as the ESR of this capacitor appears in series with the supply source impedance and lowers overall efficiency. This capacitor has to supply the relatively high peak current to the coil and smooth the current ripple on the input supply.

IS31LT3350

If the source is a DC supply, the capacitor is decided by ripple of the source, the value is given by:

$$C_{\min} = \frac{I_F * T_{on}}{\Delta U_{MAX}}$$

I_F is the value of output current, ΔU_{MAX} is the ripple of power supply. T_{on} is the "ON" time of MOSFET. The value is normally 2 times of the minimum value.

If the source is an AC supply, the typical output voltages ripple from a nominal 12V AC transformer can be $\pm 10\%$. If the input capacitor value is lower than 200 μ F, the AC input

waveform is distorted, sometimes the lowest value will be lower than the forward voltage of LED strings. This will lower the average current of the LEDs. So it is recommended to set the value of the capacitor bigger than 200 μ F.

For maximum stability over temperature and voltage, capacitors with X7R, X5R, or better dielectric are recommended. Capacitors with Y5V dielectric are not suitable for decoupling in this application and should not be used.

Inductor selection

Recommended inductor values for the IS31LT3350 are in the range of 47 μ H to 220 μ H.

Higher values of inductance are recommended at higher supply voltages and low output current in order to minimize errors due to switching delays, which result in increased ripple and lower efficiency. Higher values of inductance also result in a smaller change in output current over the supply voltage range. (See graphs). The inductor should be mounted as close to the chip as possible with low resistance connections to the LX and V_{IN} pins.

The chosen coil should have a saturation current higher than the peak output current and a continuous current rating above the required mean output current. It is recommended to use inductor with saturation current bigger than 1.2A for 700mA output current and inductor with saturation current bigger than 500mA for 350mA output current.

The inductor value should be chosen to maintain operating duty cycle and switch 'on/off' times within the specified limits over the supply voltage and load current range.

The following equations can be used as a guide.

LX Switch 'On' time

$$T_{ON} = \frac{L\Delta I}{V_{IN} - V_{LED} - I_{AVG}(R_S + rL + R_{LX})}$$

Note: $T_{ONmin} > 200ns$

LX Switch 'Off' time

$$T_{OFF} = \frac{L\Delta I}{V_{LED} + V_D + I_{AVG}(rL + R_S)}$$

Note: $T_{OFFmin} > 200ns$

Where:

L is the coil inductance (H)

r_L is the coil resistance (Ω)

I_{avg} is the required LED current (A)

ΔI is the coil peak-peak ripple current (A) {Internally set to $0.3 \times I_{avg}$ }

V_{IN} is the supply voltage (V)

V_{LED} is the total LED forward voltage (V)

R_{LX} is the switch resistance (Ω)

V_D is the diode forward voltage at the required load current (V)

Example:

For $V_{IN}=12V$, $L=47\mu H$, $r_L=0.64\Omega$, $V_{LED}=3.4V$, $I_{avg}=333mA$ and $V_D=0.36V$

$T_{ON} = (47e-6 \times 0.105)/(12 - 3.4 - 0.612) = 0.62\mu s$

$T_{OFF} = (47e-6 \times 0.105)/(3.4 + 0.36 + 0.322) = 1.21\mu s$

This gives an operating frequency of 546kHz and a duty cycle of 0.34

Optimum performance will be achieved by setting the duty cycle close to 0.5 at the nominal supply voltage. This helps to equalize the undershoot and overshoot and improves temperature stability of the output current.

Diode selection

For maximum efficiency and performance, the rectifier (D1) should be a fast low capacitance Schottky diode with low reverse leakage at the maximum operating voltage and temperature.

If alternative diodes are used, it is important to select parts with a peak current rating above the peak coil current and a continuous current rating higher than the maximum output load current. It is very important to consider the reverse leakage of the diode when operating above 85°C. Excess leakage will increase the power dissipation in the device.

The higher forward voltage and overshoot due to reverse recovery time in silicon diodes will increase the peak voltage on the LX output. If a silicon diode is used, care should be taken to ensure that the total voltage appearing on the LX pin including supply ripple, does not exceed the specified maximum value.

Reducing output ripple

Peak to peak ripple current in the LED can be reduced, if required, by shunting a capacitor C_{led} across the LED(s) as shown below:

IS31LT3350

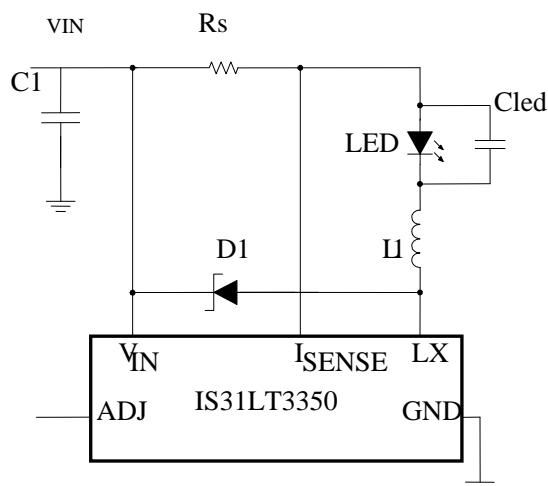

A value of $1\mu\text{F}$ will reduce nominal ripple current by a factor three (approx.). Proportionally lower ripple can be achieved with higher capacitor values. Note that the capacitor will not affect operating frequency or efficiency, but it will increase start-up delay, by reducing the rate of rise of LED voltage.

Operation at low supply voltage

The internal regulator disables the drive to the switch until the supply has risen above the startup threshold set internally which makes power MOSFET on-resistance small enough. Above this threshold, the chip will start to operate. However, with the supply voltage below the specified minimum value, the switch duty cycle will be high and the chip power dissipation will be at a maximum. Care should be taken to avoid operating the chip under such conditions in the application, in order to minimize the risk of exceeding the maximum allowed die temperature. (See next section on **thermal considerations**).

Note that when driving loads of two or more LEDs, the forward drop will normally be sufficient to prevent the chip from switching below approximately 6V. This will minimize the risk of damage to the chip.

Thermal considerations

When operating the chip at high ambient temperatures, or when driving maximum load current, care must be taken to avoid exceeding the package power dissipation limits. Two packages are available for different

application because of thermal consideration. SOT23-5 is only available for 350mA current output application. The SOT89-5 package's thermal resistance is much lower so that it can handle 700mA current and suitable for 700mA application.

Note that the chip power dissipation will most often be a maximum at minimum supply voltage. It will also increase if the efficiency of the circuit is low. This may result from the use of unsuitable coils, or excessive parasitic output capacitance on the switch output.

Layout considerations

LX pin

The LX pin of the chip is a fast switching node, so PCB traces should be kept as short as possible. To minimize ground 'bounce', the ground pin of the chip should be soldered directly to the ground plane.

Coil and decoupling capacitors

It is particularly important to mount the coil and the input decoupling capacitor close to the chip to minimize parasitic resistance and inductance, which will degrade efficiency. It is also important to take account of any trace resistance in series with current sense resistor R_s .

ADJ pin

The ADJ pin is a high impedance input, so when left floating, PCB traces to this pin should be as short as possible to reduce noise pickup. ADJ pin can also be connected to a voltage between 1.2V~5V. In this case, the internal circuit will clamp the output current at the value which is set by $\text{ADJ}=1.2\text{V}$.

High voltage traces

Avoid running any high voltage traces close to the ADJ pin, to reduce the risk of leakage due to board contamination. Any such leakage may raise the ADJ pin voltage and cause excessive output current. A ground ring placed around the ADJ pin will minimize changes in output current under these conditions.

IS31LT3350

PACKAGE INFORMATION

SOT23-5

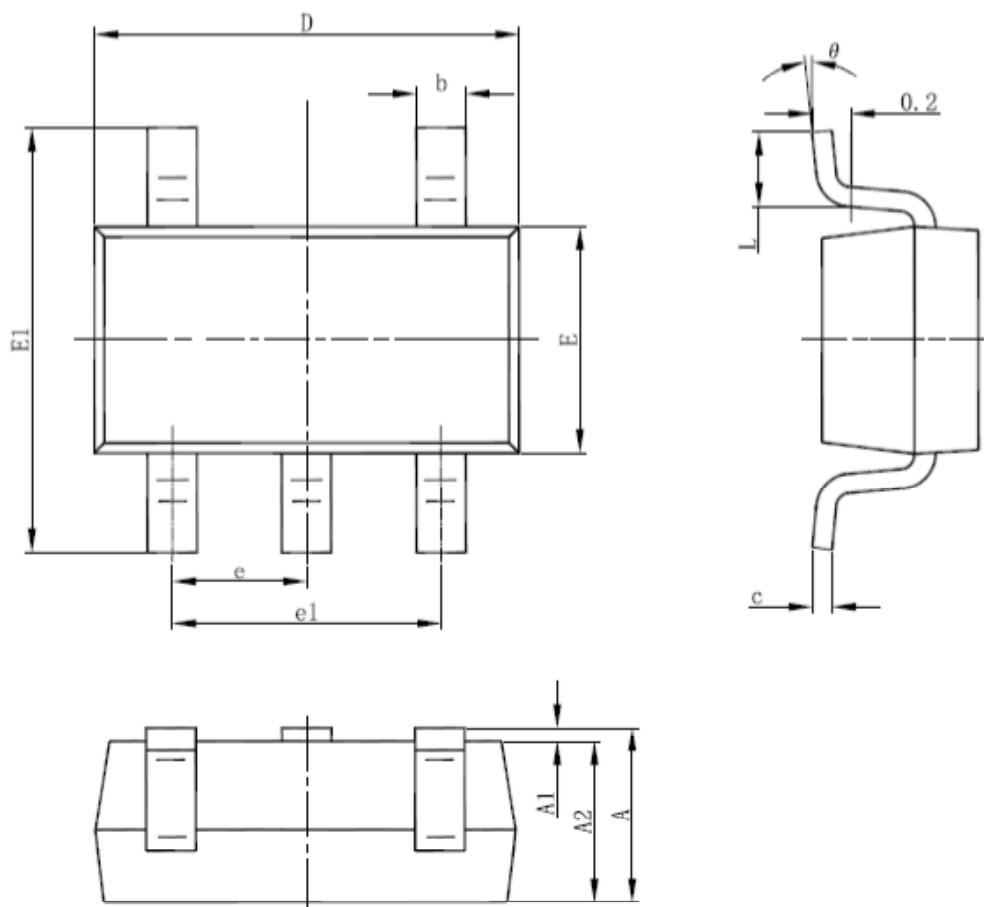

Symbol	Dimensions In Millimeters		Dimensions In Inches	
	Min	Max	Min	Max
A	1.050	1.250	0.041	0.049
A1	0.000	0.100	0.000	0.004
A2	1.050	1.150	0.041	0.045
b	0.300	0.500	0.012	0.020
c	0.100	0.200	0.004	0.008
D	2.820	3.020	0.111	0.119
E	1.500	1.700	0.059	0.067
E1	2.650	2.950	0.104	0.116
e	0.950(BSC)		0.037(BSC)	
e1	1.800	2.000	0.071	0.079
L	0.300	0.600	0.012	0.024
θ	0°	8°	0°	8°

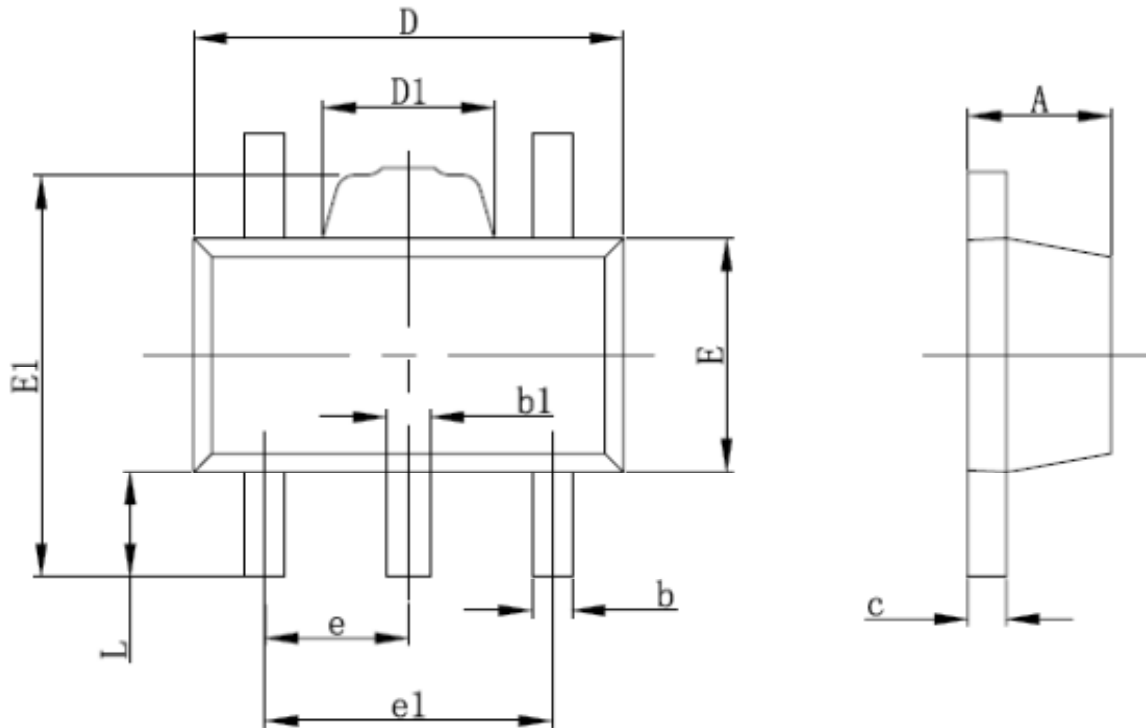

Symbol	Dimensions In Millimeters		Dimensions In Inches	
	Min	Max	Min	Max
A	1.400	1.600	0.055	0.063
b	0.320	0.520	0.013	0.020
b1	0.360	0.560	0.014	0.022
c	0.350	0.440	0.014	0.017
D	4.400	4.600	0.173	0.181
D1	1.400	1.800	0.055	0.071
E	2.300	2.600	0.091	0.102
E1	3.940	4.250	0.155	0.167
e	1.500TYP		0.060TYP	
e1	2.900	3.100	0.114	0.122
L	0.900	1.100	0.035	0.043