



MAX9791A Evaluation Kit

General Description

The MAX9791A evaluation kit (EV kit) demonstrates the MAX9791A IC, which combines a stereo Class D power amplifier, a DirectDrive® stereo headphone amplifier, and a 120mA, 4.75V low-dropout regulator (LDO) for notebook, tablet PC, and portable media player applications. Maxim's DirectDrive technology eliminates the need for bulky DC-blocking capacitors at the output of the headphone amplifier.

The EV kit is configured for a 12dB speaker amplifier gain and a 0dB headphone amplifier gain. It is designed to operate from a 4.5V to 5.5V speaker supply and an optional separate 2.7V to 5.5V headphone supply. The EV kit is capable of delivering up to 2W into a pair of 4 Ω speakers and 180mW into a 32 Ω headphone load.

Features

- ◆ No DC-Blocking Output Capacitors Required at Headphone Output
- ◆ Speaker and Headphone Operation
 - Speaker: 2W Stereo Output
 - Headphone: 180mW DirectDrive Stereo Output
- ◆ Wake-on-Beep Function
- ◆ 120mA, 4.75V LDO
- ◆ Lead-Free and RoHS Compliant
- ◆ Fully Assembled and Tested

Ordering Information

PART	TYPE
MAX9791AEVKIT+	EV Kit

+Denotes lead-free and RoHS compliant.

Component List

DESIGNATION	QTY	DESCRIPTION
REQUIRED COMPONENTS		
C1, C2, C5, C6, C25–C28	8	1 μ F \pm 10%, 10V X7R ceramic capacitors (0603) Murata GRM188R71A105K
C3, C4, C29	3	1 μ F \pm 10%, 50V X7R ceramic capacitors (0805) Murata GRM21BR71H105K
C7, C8, C9	3	0.1 μ F \pm 10%, 16V X7R ceramic capacitors (0603) Murata GRM188R71C104K
C10, C30, C31	3	10 μ F \pm 10%, 10V X7R ceramic capacitors (0805) Murata GRM21BR71A106K
R1, R2	2	20k Ω \pm 1% resistors (0603)
R3, R4, R13	3	40.2k Ω \pm 1% resistors (0603)
U1	1	Speaker and headphone amplifier with LDO (28 TQFN-EP*) Maxim MAX9791AETI+
—	1	PCB: MAX9791A Evaluation Kit+

DESIGNATION	QTY	DESCRIPTION
OPTIONAL COMPONENTS		
AVDD, HPVDD, PGND, SPOUTL+, SPOUTL-, SPOUTR+, SPOUTR-	7	Binding posts
C11–C24, C32, C33	0	Not installed, ceramic capacitors (0603)
HPL, HPR, PGND, SENSE, SPOL+, SPOL-, SPOR+, SPOR-	0	Not installed, small PCB test points
HPINL, SPINL	2	White side-entry phono jacks
HPINR, SPINR	2	Red side-entry phono jacks
HPOUT	1	3.5mm stereo headphone jack
JU1, JU2, JU3	3	3-pin headers
JU4, JU6	2	2-pin headers
JU5	0	Not installed, 2-pin header
L1–L4	0	Not installed, inductors (6.4mm x 6mm x 1.5mm)
R5–R8	4	0 Ω \pm 5% resistors (0805)
R9–R12, R14, R15	0	Not installed, resistors (0603)
R16	0	Not installed, resistor (0805)
—	5	Shunts (JU1–JU5)

*EP = Exposed pad.

DirectDrive is a registered trademark of Maxim Integrated Products, Inc.



Maxim Integrated Products 1

For pricing, delivery, and ordering information, please contact Maxim Direct at 1-888-629-4642, or visit Maxim's website at www.maxim-ic.com.

Evaluates: MAX9791A

MAX9791A Evaluation Kit

Component Suppliers

SUPPLIER	PHONE	WEBSITE
Murata Electronics North America, Inc.	770-436-1300	www.murata-northamerica.com

Note: Indicate that you are using the MAX9791A when contacting this component supplier.

Quick Start

Recommended Equipment

Before beginning, the following equipment is needed:

- One 5V, 3A DC supply
- Two 4Ω speakers
- One stereo headphone
- Two audio signal sources

Procedure

The MAX9791A EV kit is fully assembled and tested. Follow the steps below to verify board operation.

Caution: Do not turn on the power supply until all connections are completed.

- 1) Verify that shunts are installed as follows:
 - JU1: Pins 2-3 (speaker amplifier enabled)
 - JU2: Pins 1-2 (headphone amplifier enabled)
 - JU3: Pins 1-2 (LDO enabled)
 - JU4: Installed (HPVDD connected to AVDD)
 - JU6: Installed (wake-on-beep function disabled)
- 2) Set the power-supply output to 5V.
- 3) Disable the power-supply output.
- 4) Connect the power-supply ground to the PGND PCB pad and the power-supply positive output to the AVDD PCB pad.
- 5) Verify that the audio source output is disabled.
- 6) Connect the audio sources' right channels to the SPINR and HPINR phono jacks and the left channels to the SPINL and HPINL phono jacks.
- 7) Plug the headphone into the HPOUT headphone jack.
- 8) Connect one speaker across the SPOUTL+ and SPOUTL- PCB pads and the other speaker across the SPOUTR+ and SPOUTR- PCB pads.
- 9) Enable the power-supply output.
- 10) Enable the audio source.
- 11) Verify that the headphones and speakers are playing the audio source signal.

Detailed Description of Hardware

The MAX9791A evaluation kit (EV kit) demonstrates the MAX9791A IC in a 28-pin TQFN package. The IC combines a stereo Class D amplifier, a stereo DirectDrive headphone amplifier, and a 120mA, 4.75V low-dropout regulator (LDO) for notebook, tablet PC, and portable media player applications. Maxim's DirectDrive technology eliminates the need for bulky DC-blocking capacitors at the headphone amplifier output. The IC features adjustable gain.

The EV kit is configured for a 12dB speaker amplifier gain and 0dB headphone amplifier gain. The gains can be adjusted by modifying the corresponding gain-setting resistors R1–R4. R1 and R2 set the speaker amplifier gain while R3 and R4 set the headphone amplifier gain. The EV kit is designed to operate from a 4.5V to 5.5V speaker supply and an optional separate 2.7V to 5.5V headphone supply. The EV kit is capable of delivering up to 2W into a pair of 4Ω speakers, 180mW into a 32Ω headphone load, and 120mA from the LDO output.

In applications where speaker leads exceed 225mm, replace resistors R5–R8 with a surface-mount 0805 ferrite bead and install surface-mount 0603 capacitors for C11–C14. The speaker outputs do not require an output filter as the MAX9791A relies on the inherent inductance of the speaker coil and the natural filtering of an attached speaker. For optimum results, use a speaker with a series inductance > 10μH. The EV kit layout shows an optional speaker output filter for evaluation purposes.

Shutdown

Jumpers JU1, JU2, and JU3 enable or disable the speaker amplifier (SPKR_EN), the headphone amplifier (HP_EN), and the LDO (LDO_EN), respectively. See Tables 1, 2, and 3 for jumper JU1, JU2, and JU3 configuration.

Table 1. Speaker Amplifier (Jumper JU1)

SHUNT POSITION	SPKR_EN PIN	MAX9791A SPEAKER AMPLIFIER
1-2	Connected to AVDD	Disabled
2-3*	Connected to PGND	Enabled

*Default position.

MAX9791A Evaluation Kit

Table 2. Headphone Amplifier (Jumper JU2)

SHUNT POSITION	HP_EN PIN	MAX9791A HEADPHONE AMPLIFIER
1-2*	Connected to AVDD	Enabled
2-3	Connected to PGND	Disabled

*Default position.

Table 3. LDO (Jumper JU3)

SHUNT POSITION	LDO_EN PIN	MAX9791A LDO
1-2*	Connected to AVDD	Enabled
2-3	Connected to PGND	Disabled

*Default position.

Wake-on-Beep

Jumper JU6 controls the MAX9791A EV kit's wake-on-beep feature. See Table 4 for jumper JU6 configuration. Refer to the *Wake-on-Beep* section of the MAX9791/MAX9792 IC data sheet for more information.

Table 4. Wake-on-Beep (Jumper JU6)

SHUNT POSITION	BEEP PIN*	EV KIT FUNCTION
Installed**	Connected to GND	Wake-on-beep feature is disabled
Not installed	Connected to a user-supplied BEEP output	A qualified BEEP signal [†] overrides HP_EN and SPKR_EN enabling the speaker and headphone amplifiers. The LDO must be enabled (see Table 3).

***Do not leave the BEEP pin unconnected.**

**Default position.

[†]Refer to MAX9791/MAX9792 IC data sheet.

Speaker and Headphone Gain Setting

The default gain-setting resistors (R1 and R2) configure the speaker amplifier gain to 12dB. While the default gain-setting resistors (R3 and R4) configure the headphone amplifier gain to 0dB. The gain can be changed by replacing these resistors with other surface-mount 0603 resistors. Resistors with a tolerance of 1% are recommended for optimum performance. Use Table 5 and the following equations to select new gain-setting resistors for the corresponding channel:

Table 5. Component Function

CHANNEL	RIN
Speaker right	R1
Speaker left	R2
Headphone right	R3
Headphone left	R4

$$R_{IN} = -4 \left(\frac{20k\Omega}{A_{VSPKR}} \right) k\Omega$$

where A_{VSPKR} is the desired speaker voltage gain.

$$R_{IN} = - \left(\frac{40.2k\Omega}{A_{VHP}} \right) k\Omega$$

where A_{VHP} is the desired headphone voltage gain.

MAX9791A Evaluation Kit

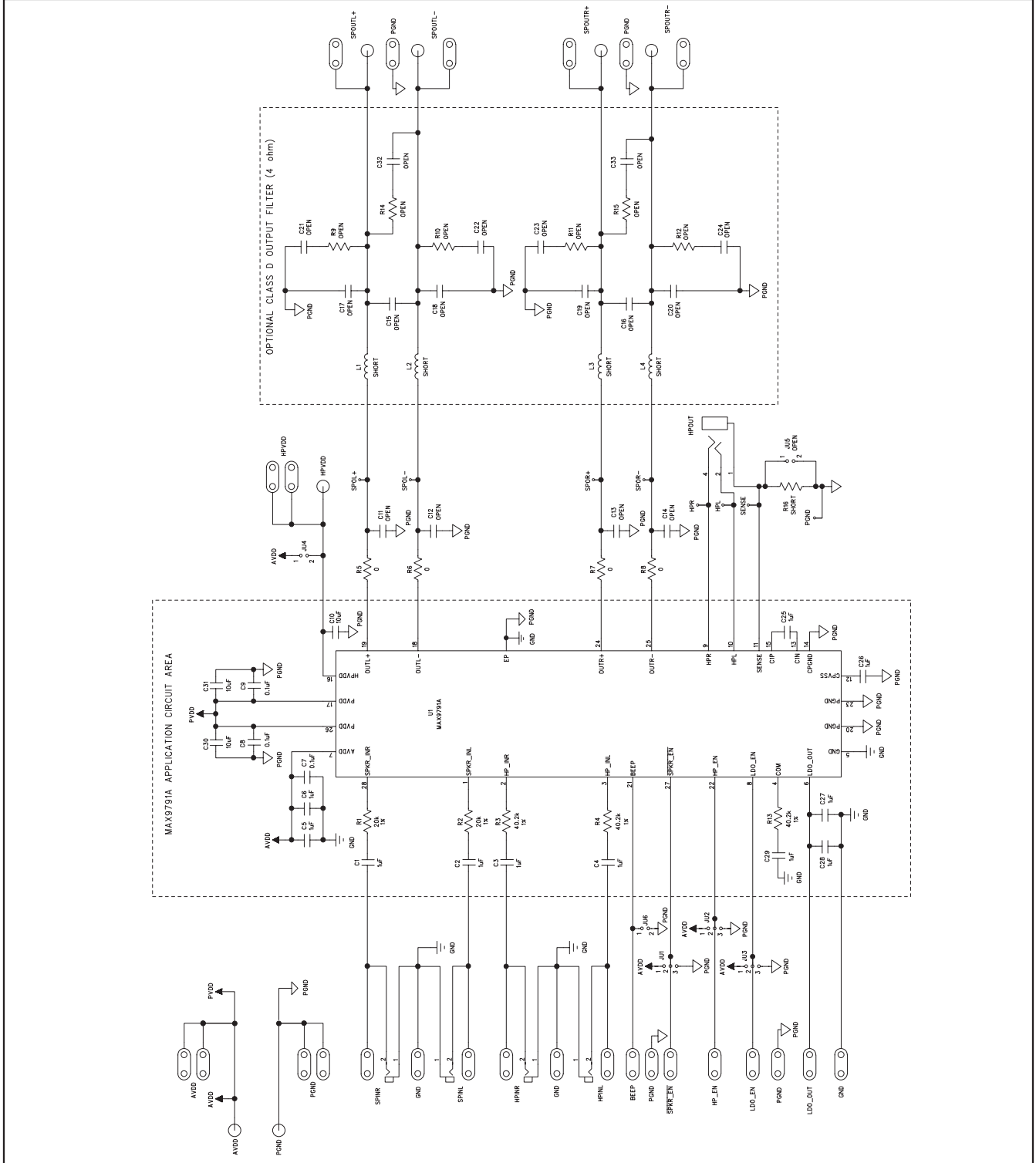

Figure 1. MAX9791A EV Kit Schematic

MAX9791A Evaluation Kit

Evaluates: MAX9791A

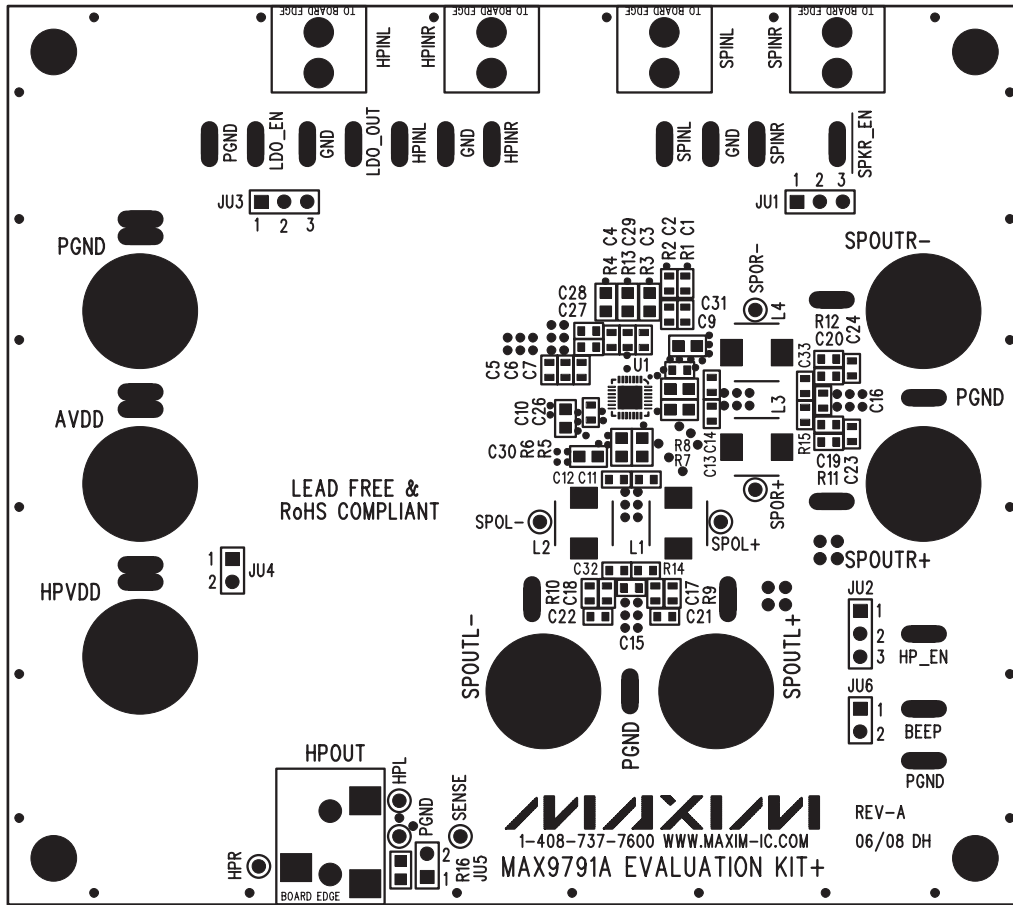

Figure 2. MAX9791A EV Kit Component Placement Guide—Component Side

MAX9791A Evaluation Kit

Evaluates: MAX9791A

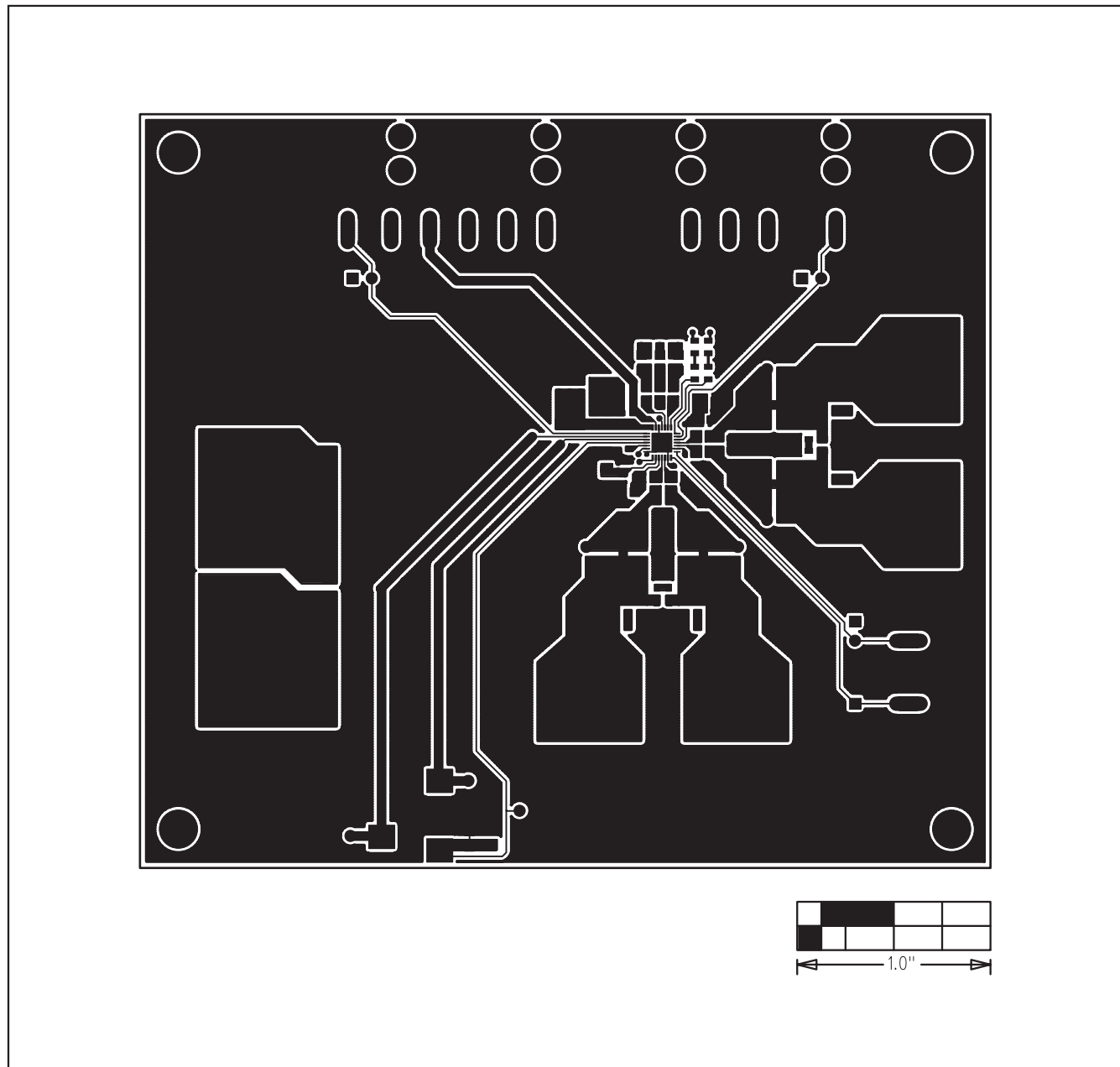

Figure 3. MAX9791A EV Kit PCB Layout—Component Side

MAX9791A Evaluation Kit

Evaluates: **MAX9791A**

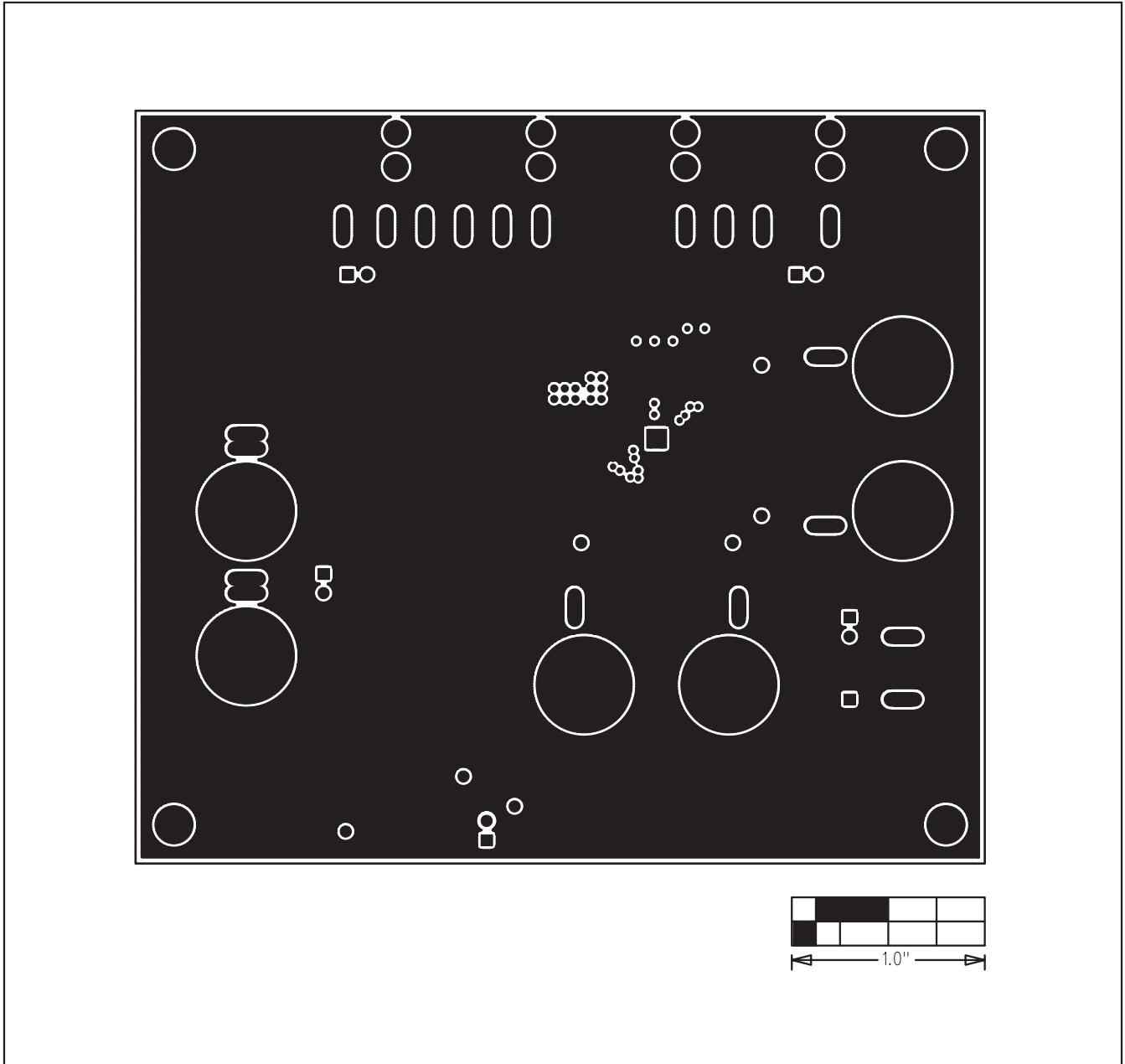

Figure 4. MAX9791A EV Kit PCB Layout—Layer 2

MAX9791A Evaluation Kit

Evaluates: MAX9791A

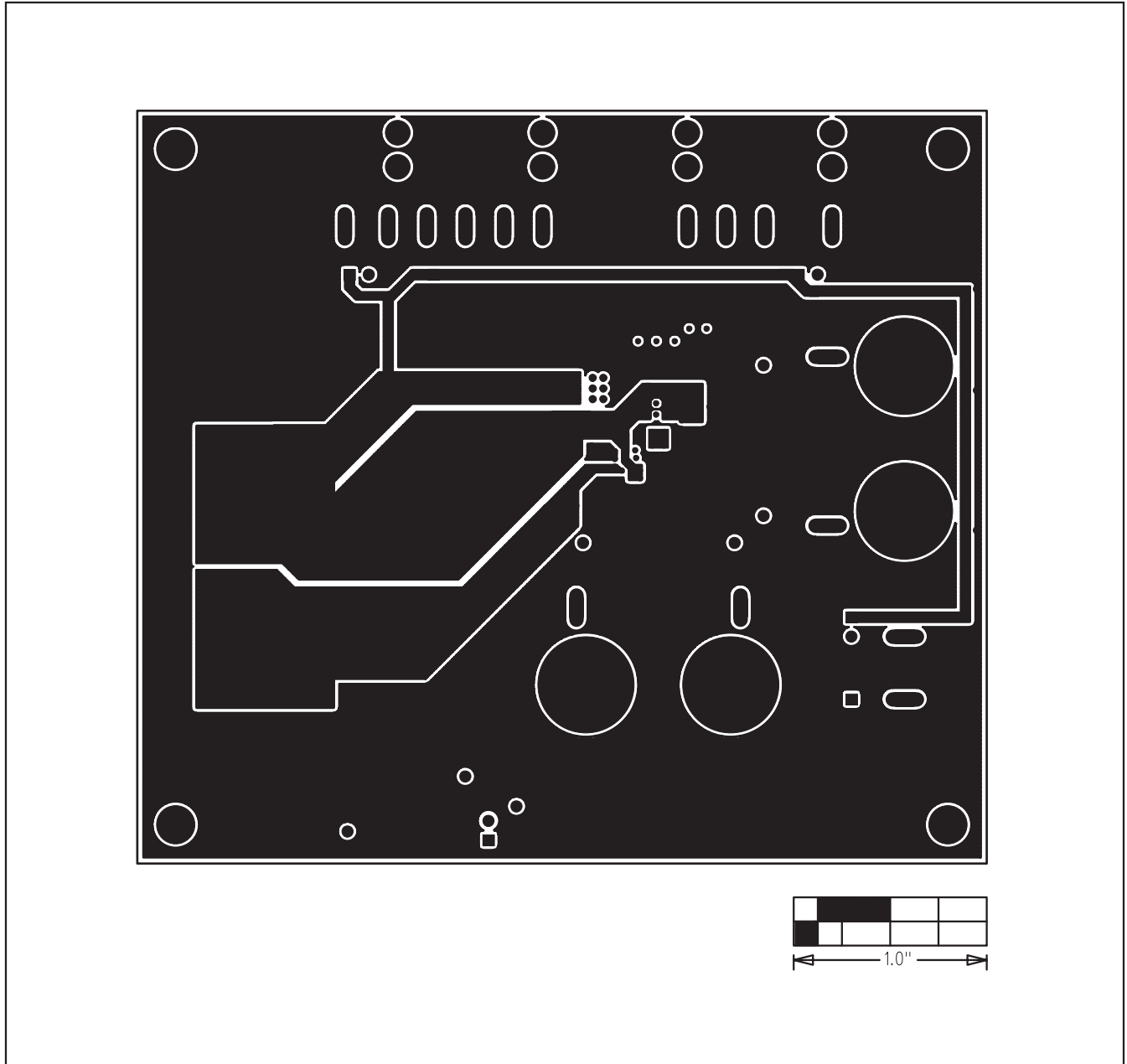

Figure 5. MAX9791A EV Kit PCB Layout—Layer 3

MAX9791A Evaluation Kit

Evaluates: MAX9791A

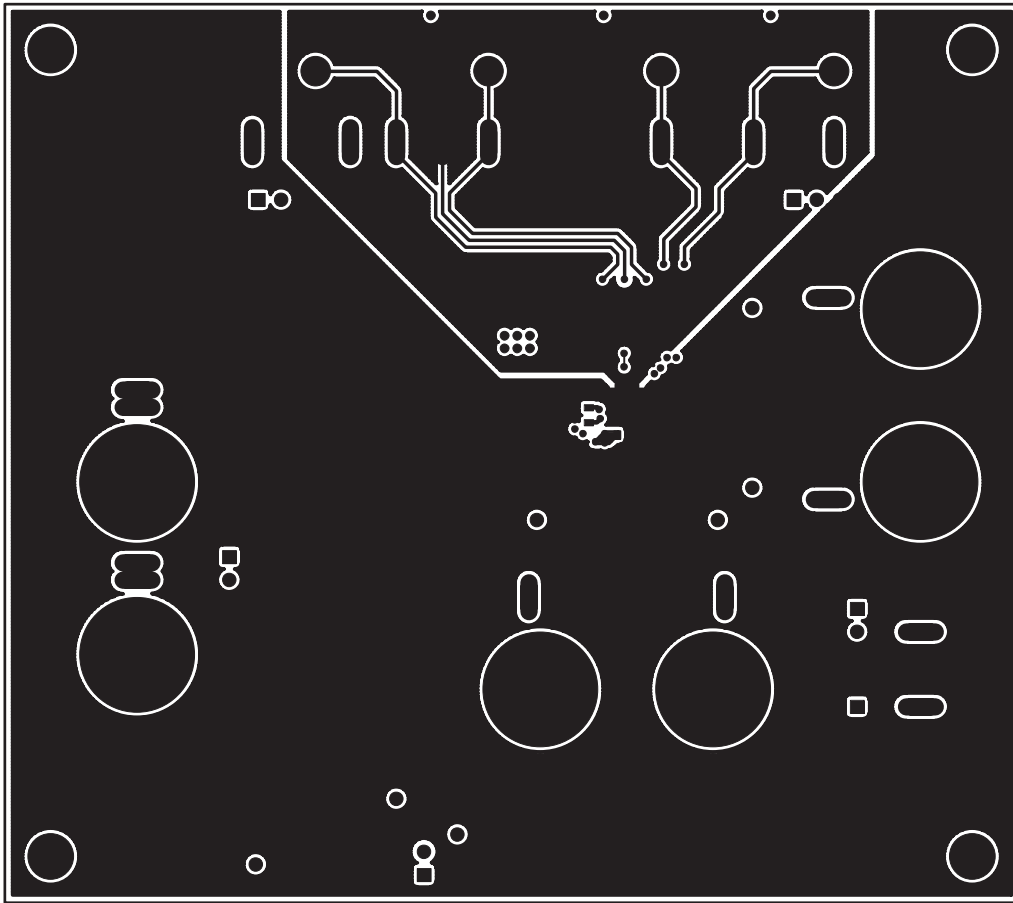

Figure 6. MAX9791A EV Kit PCB Layout—Solder Side

MAX9791A Evaluation Kit

Evaluates: MAX9791A

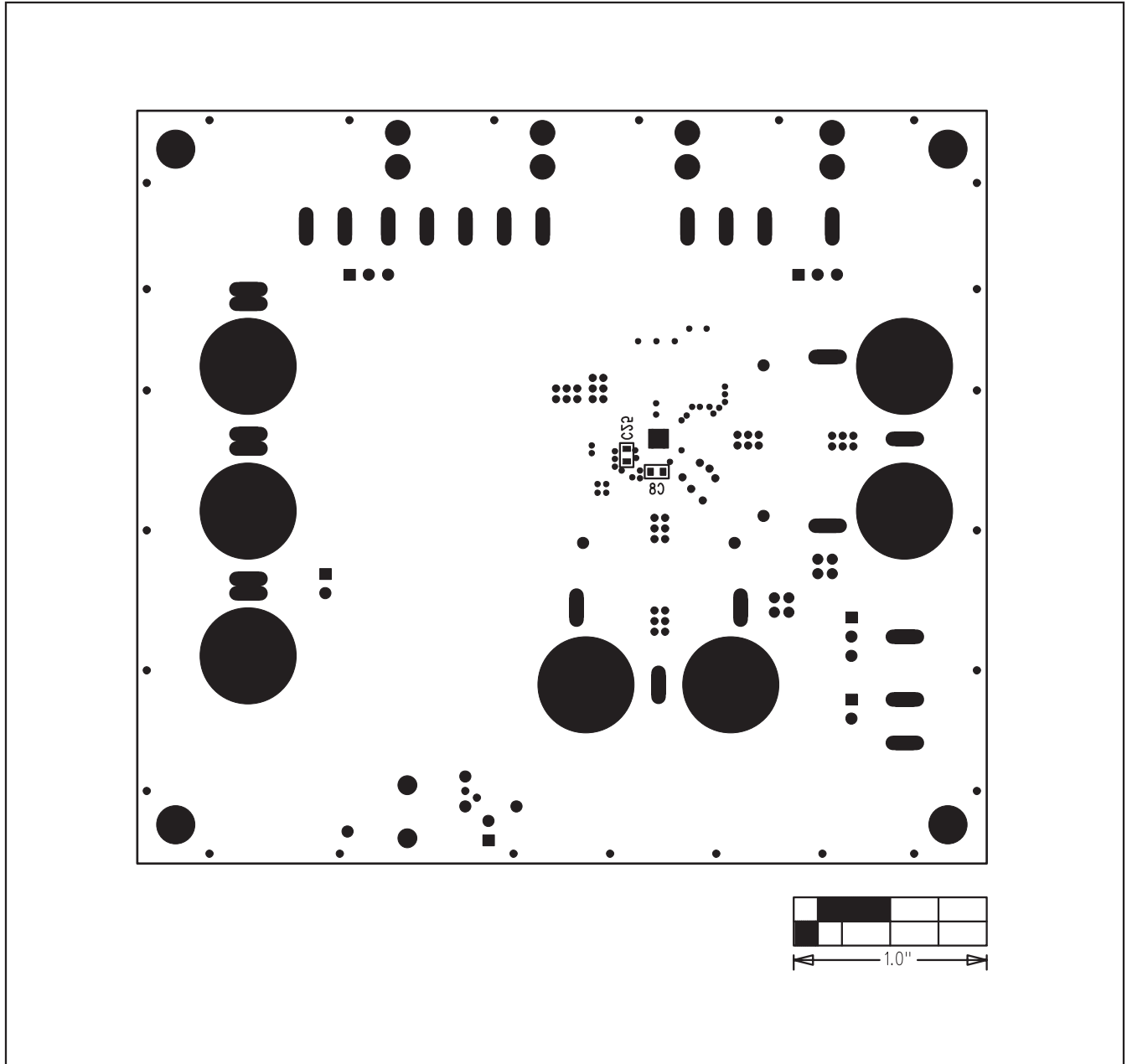

Figure 7. MAX9791A EV Kit Component Placement Guide—Solder Side

Maxim cannot assume responsibility for use of any circuitry other than circuitry entirely embodied in a Maxim product. No circuit patent licenses are implied. Maxim reserves the right to change the circuitry and specifications without notice at any time.

10 _____ **Maxim Integrated Products, 120 San Gabriel Drive, Sunnyvale, CA 94086 408-737-7600**

© 2008 Maxim Integrated Products

MAXIM is a registered trademark of Maxim Integrated Products, Inc.